

PATROL[®]
GROUP

**DIY
& BUILDING**



PATROL[®]

GROUP

Specializes in manufacturing of plastic products.
The company has been operating on the Polish market since 1991.

Firma Patrol Group jest spółką zajmującą się produkcją artykułów z tworzyw sztucznych. Działalność na rynku polskim rozpoczęliśmy w 1991 roku.

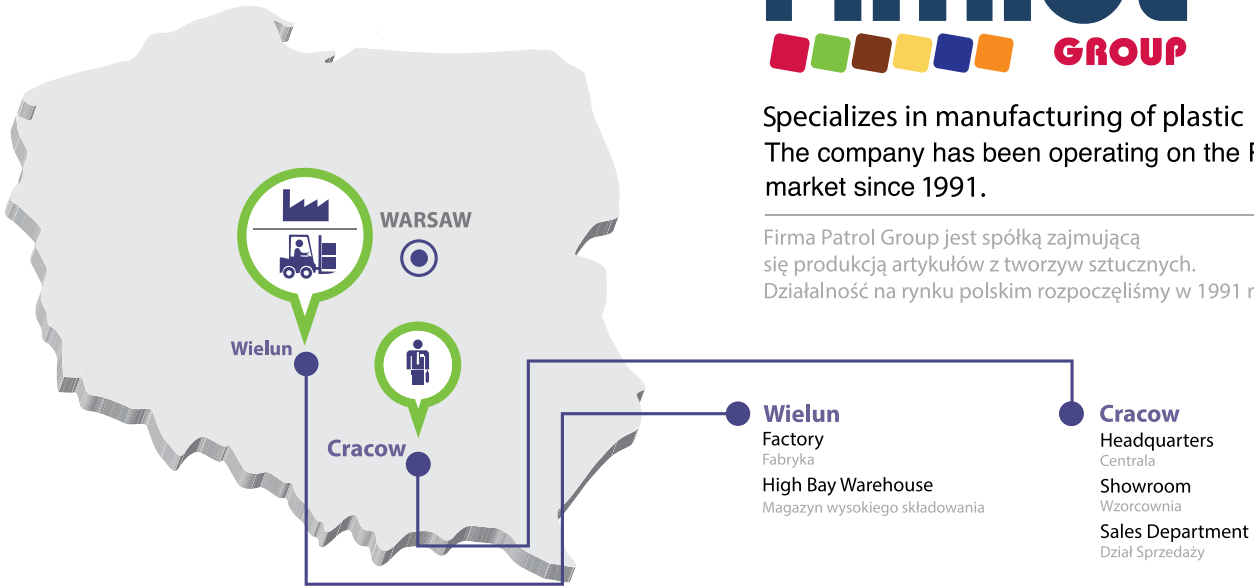

As we have gained extensive experience in the manufacture of plastic products, we are continuously adding new products to our offer.

Oferujemy naszym klientom doświadczenie w produkcji artykułów z tworzyw sztucznych, jak również systematycznie poszerzamy naszą ofertę produktową.



To ensure the highest quality our products are under regular control of both internal quality assurance department and outside auditors supervision and certification

W trosce o najwyższą jakość naszych produktów, poddajemy je stałej kontroli wewnętrznej oraz zewnętrznemu monitoringowi i certyfikacji.

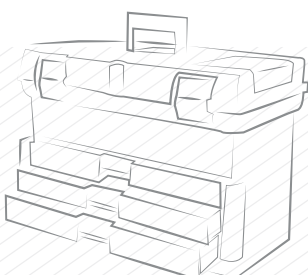

You can find our products:
Nasze produkty możesz znaleźć:



Patrol Group Spółka z ograniczoną
odpowiedzialnością S.K.A.
30-694 Kraków, ul. Koszutki 2
Poland

Regon no. 122593089
VAT EU: 6793082839
Phone: +48 12 376 45 51
Fax: +48 12 376 45 71
patrol@patrolgroup.com

patrolgroup.com

[patrolgroupPL](https://www.facebook.com/patrolgroupPL)

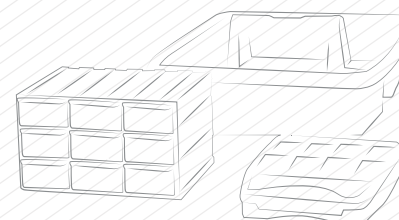
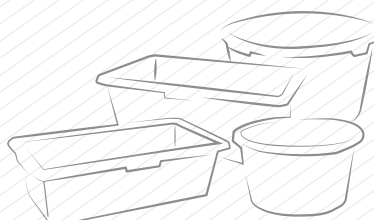
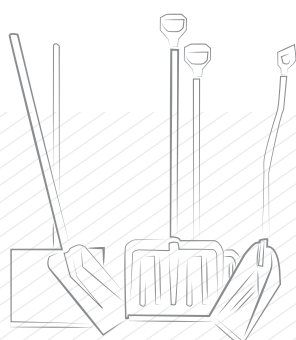

DIY LINE

Toolboxes HD Skrzynki narzędziowe HD



	HD Compact Logic	10
	HD Compact	11
	HD Trophy	14
	WheelBox HD Trophy	18
	Wheelbox HD Compact 1	20
	Compact Module System	21
	Wheelbox HD Compact Logic	22
	HD Organisers	24
	HD Case	26

Toolboxes FORMULA CARBO Skrzynki narzędziowe FORMULA CARBO



	Formula S Carbo	30
	Formula RS Carbo	32
	Formula RS Carbo FLEX	34

Toolboxes FORMULA Skrzynki narzędziowe FORMULA

	Formula A	36
	Formula S	38

Toolboxes STUFF CARBO Skrzynki narzędziowe STUFF CARBO



	STUFF Semi Profi Carbo	42
	STUFF Module System Carbo	43

Toolboxes STUFF Skrzynki narzędziowe STUFF

	STUFF Optimo P	46
	STUFF Optimo B	47
	STUFF SP	48
	STUFF Basic	49
	STUFF Semi Profi	51
	STUFF Module System	54
	Wheelbox STUFF	56



Toolboxes ERGO

Skrzynki narzędziowe ERGO

	ERGO Basic	62
	ERGO Expert	63

Carriages & ToolCases

Nosidła i pojemniki na elektronarzędzia

	Carriages	66
	ToolCases	67

Organisers TANDEM

Organizery TANDEM

	Tandem A	70
	Tandem B	71
	Tandem C	72
	Tandem TWIN	73

CombiBoxes

CombiBoxes

	CombiBoxes	74
---	------------	----

Organisers Domino

Organizery Domino

	Organisers Domino	76
---	-------------------	----







Organisers Classic

Organizery Classic

	Organisers Classic	79
---	--------------------	----

Workshop Storage

Organizacja warsztatu

	EcoBox	84
	ErgoBox	85
	ErgoBox Plus	85
	ModulBox	87
	FixingWall	88
	Pegboard Kit	90
	Accessories	91

Multi-functional Boxes



Pojemniki wielofunkcyjne

	Multi-functional Boxes	94
--	------------------------	----

BUILDING LINE



Building Buckets

Wiadra budowlane

	Bucket without funnel	98
	Bucket with funnel	98

Building Containers

Kastry

	Rectangular Container	100
	Round Container	101
	Round Container with rope	102



patrolgroup.com

2019/2020

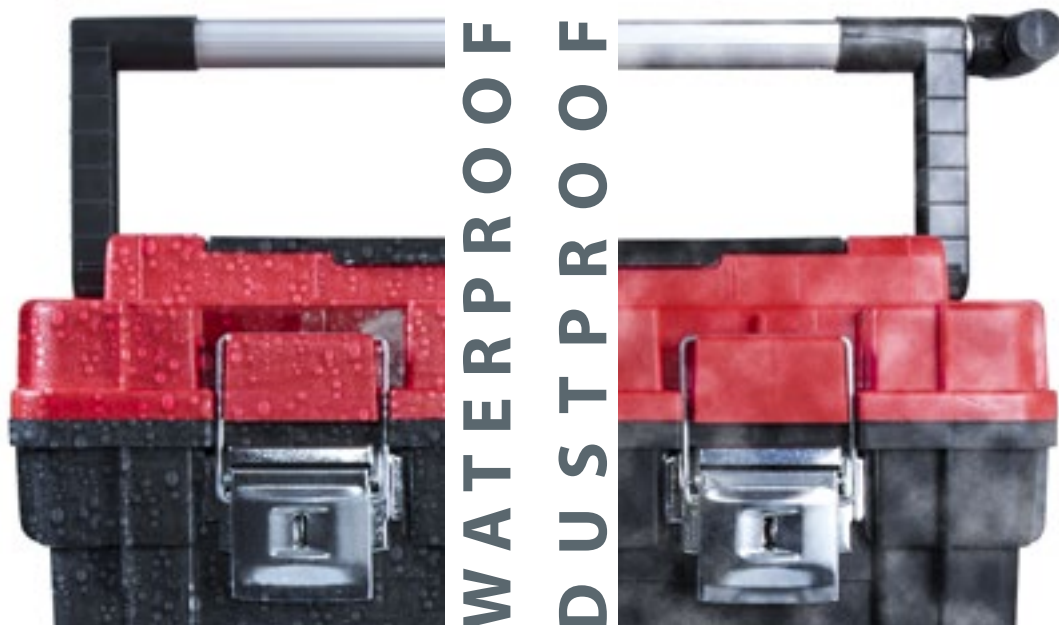

ToolBoxes HD



Skrzynki narzędziowe
HD

Many years of our experience in the production of plastic, months of design and testing have led us to create a completely new class of waterproof and dustproof toolboxes - Heavy Duty line. Dedicated to professionals boxes are characterized by exceptional strength, load capacity as well as numerous ergonomic solutions. The quality of this product line is guaranteed by the certificate IP54. Each of the boxes has a carriage, measure tape, padlock, side handles and the ability to install additional tool holsters. Despite it's large dimensions, the box is practical and comfortable to use. HD Compact is ideal for people who need box to carry medium sized tools. HD Trophy is a toolbox of far larger size - its capacity and load will satisfy each professional. For the most demanding users we have created also HD. WheelBox - rather than carry heavy tools now you can effortlessly transport them to the workplace.

Nasze wieloletnie doświadczenie w produkcji z tworzyw sztucznych, miesiące projektowania oraz testów pozwoliły nam na stworzenie całkowicie nowej klasy skrzynek narzędziowych odpornych na szkodliwe działanie wody i pyłu – linii Heavy Duty. Dedykowane profesjonalistom skrzynki charakteryzują się wyjątkową wytrzymałością, ładownością, a także licznymi rozwiązaniami podnoszącymi ergonomię pracy. Potwierdzeniem ponadprzeciętnej solidności tej linii produktów jest przyznanie jej certyfikatu jakości IP54. Każda ze skrzynek posiada nosidło, miarkę, miejsce na kłódkę, uchwyty boczne oraz możliwość zamontowania dodatkowych kabur narzędziowych. Pomimo dużych gabarytów skrzynki są praktyczne i wygodne w użytkowaniu. HD Compact jest idealnym rozwiązaniem dla osób, które potrzebują skrzynki do przenoszenia narzędzi o niezbyt dużych gabarytach. HD Trophy jest skrzynką o zdecydowanie większych rozmiarach – jej pojemność oraz ładowność zadowoli każdego fachowca. Dla najbardziej wymagających użytkowników stworzyliśmy także skrzynkę HD WheelBox – zamiast nosić ciężkie narzędzia teraz bez wysiłku można je przewieźć na miejsce pracy.



CAPTION
LEGENDA

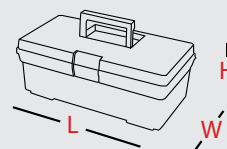

ToolBoxes | HD

Skrzynki narzędziowe HD



Available colors
Dostępne kolory



Measure - placed on the cover of ToolBox HD Compact.

Miarka - wbudowana w pokrywę skrzynki HD Compact.



HD Alu handle - solid, elongated handle makes it possible to lift the box with both hands, thus facilitating the transport of your box, even when it is filled with heavy tools.

Alu rączka HD- solidny, wydłużony uchwyt umożliwia podniesienie skrzynki dwoma rękami, co ułatwia jej przeniesienie, nawet przy wypełnieniu ciężkimi narzędziami.

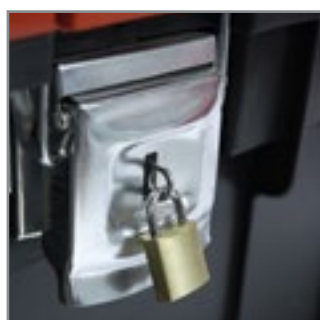

Metal latches - allow for safe transportation of heavy loads. Padlock hole allows you to protect stored tools against theft.

Metalowe zapięcia - pozwalają na bezpieczny transport ciężkiego ładunku. Uchwyt na kłódkę umożliwia zabezpieczenie magazynowanych narzędzi przed kradzieżą.



Side handles - help you to carry ToolBox filled with heavy tools.

Uchwyty boczne - ułatwiają przenoszenie maksymalnie obciążonej skrzynki.



Tool holster - easy to assemble, ideal additional to HD Toolboxes. Allows you to store and transport power tools and accessories.

Kabura Narzędziowa - łatwa w montażu, stanowiąca doskonały dodatek do skrzynki narzędziowej HD. Pozwala na przechowywanie i przenoszenie elektronarzędzi oraz akcesoriów.



Anti-slip - lower corners of the box are made of anti-slip elasto. They give the bottom added protection against damage in case of accidental dropping.

Nóżki - wykonane są z antypoślizgowego elastomeru zwanego adflex. Dolne rogi skrzynki. Chronią dodatkowo jej spód przed pękaniem przy upuszczeniach.



Portable workshop - thanks to a specially made handle, you can transform your box into a mini tool table.

Mini warsztat - dzięki specjalnemu uchwytowi, możliwa jest przemiana skrzynki w mini stół narzędziowy.



Carriage - it is equipped with holes for smaller elements, such as keys, screwdrivers or measuring tape - in this way, all tools are readily accessible.

Nosidło - posiada otwory przeznaczone na mniejsze elementy, takie jak klucze, śrubokręty czy taśmę mierniczą, dzięki którym otrzymuje się łatwy dostęp do wszystkich narzędzi.

*tools not included/nie zawiera narzędzi



Specially designed cover facilitates trimming various kinds of materials.

Wyprofilowana pokrywa ułatwia przycinanie różnego rodzaju materiałów.



Expert organizer – located on the cover, helps to keep small elements in order, and pull-out partitions enable to adjust their sizes to the size of tools.

Organizer Expert - umiejscowiony na całej powierzchni pokrywy, pozwala na łatwe utrzymanie porządku wśród drobnych elementów, a wysuwane przegrody umożliwiają dopasowanie ich wielkości do rozmiarów posiadanych narzędzi.



HD Compact 1 and HD Trophy 1 offer the possibility of sitting or standing on their covers.

HD Compact 1 i HD Trophy 1 umożliwiają stanie lub siedzenie na ich pokrywach.

Portable workshop – thanks to a specially made handle, you can transform your box into a mini tool table.

Mini warsztat - dzięki specjalnemu uchwytowi, możliwa jest przemiana skrzynki w mini stół narzędziowy.

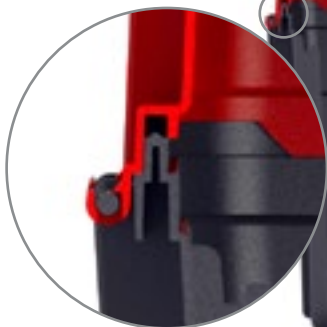

**WATERPROOF
DUSTPROOF**

The special construction of the lid and the body of HD toolboxes gives them a high resistance to water splashes and harmful effects of dust. Quality confirmed by certified IP54!

Specjalna konstrukcja pokrywy oraz korpusu skrzynki z linii HD zapewnia im wysoką odporność na zachlapania wodą i szkodliwy wpływ kurzu. Jakość potwierdzona przez certyfikat IP54!



*tools not included/nie zawiera narzędzi

ToolBox HD Compact Logic

Skrzynka narzędziowa HD Compact Logic

445 (L) x 350(W) x 300(H) mm

360 (L) x 315 (W) x 260 (H) mm

COLOR	INDEX	EAN		
●	SKRCLHDCZAPG001	5901238244639	42	6





4 x Organizer on lid
4 x Organizer w pokrywie
Metal latches
Metalowe zapięcia
Anti-slip legs
Antypoślizgowe nóżki
Polycarbonate on lid
Poliwęglanowe pokrywy organizerów
Deep tray
Głęboka tacka
HD handle
Rączka HD

ToolBox HD Compact Logic Color

Skrzynka narzędziowa HD Compact Logic Color

445 (L) x 350(W) x 300(H) mm

360 (L) x 315 (W) x 260 (H) mm

COLOR	INDEX	EAN		
●	SKRCLHDCZEPG001	5901238244646	42	6
●	SKRCLHDPOMPG001	5901238244660	42	6

OPTIONAL
COLOR

●	SKRCLHDNIEPG001	5901238244653	42	6
●	SKRCLHDZOLPG001	5901238244677	42	6



4 x Organizer on lid
4 x Organizer w pokrywie
Metal latches
Metalowe zapięcia
Anti-slip legs
Antypoślizgowe nóżki
Polycarbonate on lid
Poliwęglanowe pokrywy organizerów
Deep tray
Głęboka tacka
HD handle
Rączka HD





ToolBox HD Compact 1

Skrzynka narzędziowa HD Compact 1

450 (L) x 350(W) x 350(H) mm

360 (L) x 300 (W) x 270 (H) mm

COLOR	INDEX	EAN		
●	SKRC1HDCZAPG001	5901238215158	36	6



HD Alu handle
Alu rączka HD
Metal latches
Metalowe zapięcia
Deep tray
Głęboka tacka
Anti-slip legs
Antypoślizgowe nóżki
Portable workshop
Mini warsztat
Measure on the cover 40 cm
Miarka na pokrywie 40 cm



Carriage Basic
Nosidło Basic

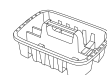



*Optional
*Opcjonalnie

ToolBox HD Compact 1 Color

Skrzynka narzędziowa HD Compact 1 Kolor

450 (L) x 350(W) x 350(H) mm

360 (L) x 300 (W) x 270 (H) mm

COLOR	INDEX	EAN		
●	SKRC1HDCZEPG001	5901238215387	36	6
●	SKRC1HDPOMPG001	5901238215394	36	6



HD Alu handle
Alu rączka HD
Metal latches
Metalowe zapięcia
Deep tray
Głęboka tacka
Anti-slip legs
Antypoślizgowe nóżki
Portable workshop
Mini warsztat
Measure on the cover 40 cm
Miarka na pokrywie 40 cm

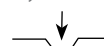

Carriage Basic
Nosidło Basic

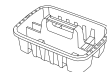



*Optional
*Opcjonalnie

ToolBox HD Compact 1 Plus

Skrzynka narzędziowa HD Compact 1 Plus

450 (L) x 350(W) x 350(H) mm

360 (L) x 300 (W) x 260 (H) mm

COLOR	INDEX	EAN		
●	SKRC1HDPCZAPG001	5901238215349	36	6
●	SKRC1HDPCZEPG001	5901238216063	36	6
●	SKRC1HDPPOMPG001	5901238216032	36	6



HD Alu handle
Alu rączka HD
Metal latches
Metalowe zapięcia
Deep tray
Głęboka tacka
Anti-slip legs
Antypoślizgowe nóżki
Portable workshop
Mini warsztat
Measure on the cover 40 cm
Miarka na pokrywie 40 cm

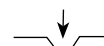

Carriage Basic
Nosidło Basic

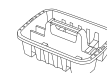

*Optional
*Opcjonalnie

Tool Holsters
Kabury narzędziowe

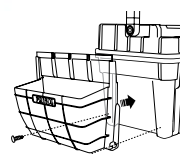



ToolBox HD Compact 2

Skrzynka narzędziowa HD Compact 2

450 (L) x 350(W) x 350(H) mm

360 (L) x 300 (W) x 270 (H) mm

COLOR	INDEX	EAN		
●	SKRC2HDCZAPG001	5901238244684	36	6



HD Alu handle
Alu rączka HD
Metal latches
Metalowe zapiecia
Deep tray
Głęboka tacka
Anti-slip legs
Antypoślizgowe nóżki
Portable workshop
Mini warsztat

Carriage Basic
Nosidło Basic

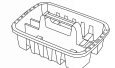



*Optional
*Opcjonalnie

ToolBox HD Compact 2 Color

Skrzynka narzędziowa HD Compact 2 Kolor

450 (L) x 350(W) x 350(H) mm

360 (L) x 300 (W) x 270 (H) mm

COLOR	INDEX	EAN		
●	SKRC2HDCZEPG001	5901238244691	36	6
●	SKRC2HDPOMPG001	5901238244707	36	6



HD Alu handle
Alu rączka HD
Metal latches
Metalowe zapiecia
Deep tray
Głęboka tacka
Anti-slip legs
Antypoślizgowe nóżki
Portable workshop
Mini warsztat

Carriage Basic
Nosidło Basic

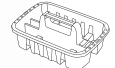



*Optional
*Opcjonalnie

ToolBox HD Compact 2 Plus

Skrzynka narzędziowa HD Compact 2 Plus

450 (L) x 350(W) x 350(H) mm

360 (L) x 300 (W) x 260 (H) mm

COLOR	INDEX	EAN		
●	SKRC2HDPCZAPG001	5901238244714	36	6
●	SKRC2HDPCZEPG001	5901238244721	36	6
●	SKRC2HDPPOMPG001	5901238244738	36	6



HD Alu handle
Alu rączka HD
Metal latches
Metalowe zapiecia
Deep tray
Głęboka tacka
Anti-slip legs
Antypoślizgowe nóżki
Portable workshop
Mini warsztat

Carriage Basic
Nosidło Basic

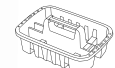

*Optional
*Opcjonalnie

Tool Holsters
Kabury narzędziowe

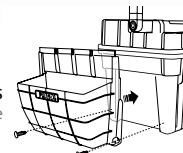



ToolBox HD Compact 2 Carbo

Skrzynka narzędziowa HD Compact 2 Carbo

450 (L) x 350(W) x 350(H) mm

360 (L) x 300 (W) x 270 (H) mm

COLOR	INDEX	EAN		
●	SKRC2HDCARCZAPG001	5901238244745	36	6



HD Alu handle
Alu rączka HD
Metal latches
Metalowe zapięcia
Deep tray
Głęboka tacka
Anti-slip legs
Antypoślizgowe nóżki
Portable workshop
Mini warsztat

Carriage Basic
Nosidło Basic

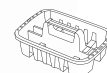



*Optional
*Opcjonalnie

ToolBox HD Compact 2 Carbo Color

Skrzynka narzędziowa HD Compact 2 Carbo Kolor

450 (L) x 350(W) x 350(H) mm

360 (L) x 300 (W) x 270 (H) mm

COLOR	INDEX	EAN		
●	SKRC2HDCARCZEPG001	5901238244752	36	6
●	SKRC2HDCARPOMPG001	5901238244769	36	6



HD Alu handle
Alu rączka HD
Metal latches
Metalowe zapięcia
Deep tray
Głęboka tacka
Anti-slip legs
Antypoślizgowe nóżki
Portable workshop
Mini warsztat

Carriage Basic
Nosidło Basic

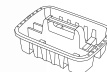



*Optional
*Opcjonalnie

ToolBox HD Compact 2 Carbo Plus

Skrzynka narzędziowa HD Compact 2 Carbo Plus

450 (L) x 350(W) x 350(H) mm

360 (L) x 300 (W) x 260 (H) mm

COLOR	INDEX	EAN		
●	SKRC2HDPCZAPG001	5901238244714	36	6
●	SKRC2HDPCZEPG001	5901238244721	36	6
●	SKRC2HDPPOMPG001	5901238244738	36	6



HD Alu handle
Alu rączka HD
Metal latches
Metalowe zapięcia
Deep tray
Głęboka tacka
Anti-slip legs
Antypoślizgowe nóżki
Portable workshop
Mini warsztat

Carriage Basic
Nosidło Basic

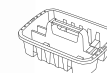

*Optional
*Opcjonalnie

Tool Holders
Kabury narzędziowe

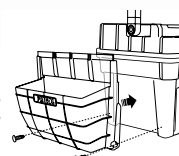



ToolBox HD Trophy 1

Skrzynka narzędziowa HD Trophy 1

↕ 595 (L) x 345(W) x 355(H) mm

⊞ 515 (L) x 270 (W) x 270 (H) mm

COLOR	INDEX	EAN		
●	SKRT1HDCZAPG001	5901238209089	24	4



HD Alu handle
Alu rączka HD
Metal latches
Metalowe zapięcia
Carriage
Nosidło
Anti-slip legs
Antypoślizgowe nóżki
Portable workshop
Mini warsztat
Measure 50 cm
Miarka 50 cm

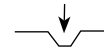



ToolBox HD Trophy 1 Color

Skrzynka narzędziowa HD Trophy 1 Kolor

↕ 595 (L) x 345(W) x 355(H) mm

⊞ 515 (L) x 270 (W) x 270 (H) mm

COLOR	INDEX	EAN		
●	SKRT1HDCZEPG001	5901238209096	24	4
●	SKRT1HDPOMPG001	5901238209102	24	4



HD Alu handle
Alu rączka HD
Metal latches
Metalowe zapięcia
Carriage
Nosidło
Anti-slip legs
Antypoślizgowe nóżki
Portable workshop
Mini warsztat
Measure 50 cm
Miarka 50 cm





ToolBox HD Trophy 1 Plus

Skrzynka narzędziowa HD Trophy 1 Plus

↕ 595 (L) x 345(W) x 355(H) mm

⊞ 515 (L) x 270 (W) x 270 (H) mm

COLOR	INDEX	EAN		
●	SKRT1HDPCZAPG001	5901238215097	24	4
●	SKRT1HDPCZEPG001	5901238216865	24	4
●	SKRT1HDPPOMPG001	5901238221579	24	4



HD Alu handle
Alu rączka HD
Metal latches
Metalowe zapięcia
Carriage
Nosidło
Anti-slip legs
Antypoślizgowe nóżki
Portable workshop
Mini warsztat
Measure 50 cm
Miarka 50 cm





ToolBox HD Trophy 2

Skrzynka narzędziowa HD Trophy 2

595 (L) x 345(W) x 355(H) mm

515 (L) x 260 (W) x 275 (H) mm

COLOR	INDEX	EAN		
●	SKRT2HDCZAPG001	5902455507705	24	4



HD Alu handle
Alu rączka HD
Metal latches
Metalowe zapiecia
Carriage
Nosidlo
Side handles
Uchwyty boczne
Anti-slip legs
Antypoślizgowe nóżki
Portable workshop
Mini warsztat
Expert organizer
Organizer Expert





ToolBox HD Trophy 2 Color

Skrzynka narzędziowa HD Trophy 2 Kolor

595 (L) x 345(W) x 355(H) mm

515 (L) x 260 (W) x 275 (H) mm

COLOR	INDEX	EAN		
●	SKRT2HDCZEPG001	5902455502335	24	4
●	SKRT2HDPOMPG001	5902455505213	24	4



HD Alu handle
Alu rączka HD
Metal latches
Metalowe zapiecia
Carriage
Nosidlo
Side handles
Uchwyty boczne
Anti-slip legs
Antypoślizgowe nóżki
Portable workshop
Mini warsztat
Expert organizer
Organizer Expert





ToolBox HD Trophy 2 Plus

Skrzynka narzędziowa HD Trophy 2 Plus

595 (L) x 345(W) x 355(H) mm

515 (L) x 260 (W) x 275 (H) mm

COLOR	INDEX	EAN		
●	SKRT2HDPCZAPG001	5901238215172	24	4
●	SKRT2HDPCZEPG001	5901238215103	24	4
●	SKRT2HDPPOMPG001	5901238215868	24	4



HD Alu handle
Alu rączka HD
Metal latches
Metalowe zapiecia
Carriage
Nosidlo
Anti-slip legs
Antypoślizgowe nóżki
Portable workshop
Mini warsztat
Expert organizer
Organizer Expert



Tool Holders
Kabury narzędziowe

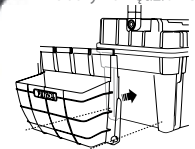



ToolBox HD Trophy 2 Carbo

Skrzynka narzędziowa HD Trophy 2 Carbo

↕ 595 (L) x 345(W) x 355(H) mm

⊞ 515 (L) x 260 (W) x 275 (H) mm

COLOR	INDEX	EAN		
●	SKRT2HDCARCZAPG001	5901238244806	24	4



HD Alu handle
Alu rączka HD
Metal latches
Metalowe zapięcia
Carriage
Nosidło
Anti-slip legs
Antypoślizgowe nóżki
Portable workshop
Mini warsztat
Polycarbonate on lid
Poliwęglanowe pokrywy
organizatorów
Expert organizer
Organizer Expert





ToolBox HD Trophy 2 Carbo Color

Skrzynka narzędziowa HD Trophy 2 Carbo Kolor

↕ 595 (L) x 345(W) x 355(H) mm

⊞ 515 (L) x 260 (W) x 275 (H) mm

COLOR	INDEX	EAN		
●	SKRT2HDCARCZEPG001	5901238244813	24	4
●	SKRT2HDCARPOMPG001	5901238244820	24	4



HD Alu handle
Alu rączka HD
Metal latches
Metalowe zapięcia
Carriage
Nosidło
Anti-slip legs
Antypoślizgowe nóżki
Portable workshop
Mini warsztat
Polycarbonate on lid
Poliwęglanowe pokrywy
organizatorów
Expert organizer
Organizer Expert





ToolBox HD Trophy 2 Carbo Plus

Skrzynka narzędziowa HD Trophy 2 Plus

↕ 595 (L) x 345(W) x 355(H) mm

⊞ 515 (L) x 260 (W) x 275 (H) mm

COLOR	INDEX	EAN		
●	SKRT2HDPCARCZAPG001	5901238244837	24	4
●	SKRT2HDPCARCZEPG001	5901238244844	24	4
●	SKRT2HDPCARPOMPG001	5901238244851	24	4



HD Alu handle
Alu rączka HD
Metal latches
Metalowe zapięcia
Carriage
Nosidło
Anti-slip legs
Antypoślizgowe nóżki
Portable workshop
Mini warsztat
Polycarbonate on lid
Poliwęglanowe pokrywy
organizatorów
Expert organizer
Organizer Expert



Tool Holsters
Kabury narzędziowe

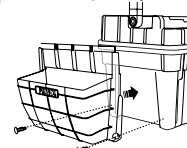





WheelBox HD Trophy

Skrzynki narzędziowe
na kółkach HD

Available colors
Dostępne kolory



Wheelbox HD Trophy provides users high comfort and ergonomics. This is possible thanks to the tough, reinforced construction of the box. Telescopic handle with ability of adjustment, and plastic wheels protected with rubber layer makes, that carrying the tools will not cause you a problem.

Wheelbox HD Trophy zapewnia użytkownikom wysoki komfort i ergonomię pracy. Jest to możliwe dzięki przemyślanej, wzmocnionej konstrukcji tej skrzynki. Teleskopowa rączka z możliwością precyzyjnej regulacji oraz plastikowe kółka zabezpieczone warstwą gumy sprawiają, że przenoszenie narzędzi nie będzie sprawiać problemu.



Plastic wheels – the rubber layer protects them from mechanical defects.

Kółka z plastiku są zabezpieczone warstwą gumy zapewniającej odporność na uszkodzenia mechaniczne.



Wheel HD Alu handle – drawn handle is comfortable to use. It allows you to save the place during transport and storage.

Rączka aluminiowa Wheel HD – zastosowana rozkładana rączka jest wygodna w użyciu i pozwala na oszczędność miejsca podczas transportu i magazynowania.



HD WheelBox



HD Trophy

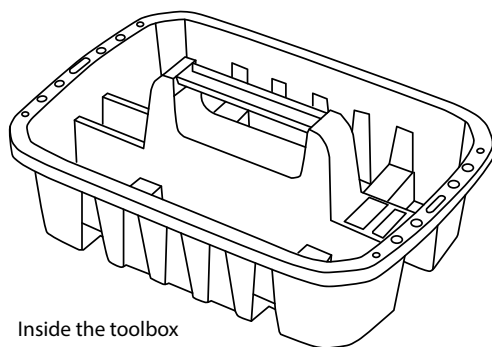

Inside the toolbox
Carriage Basic
W środku skrzynki
Nosidło Basic

Carriage Basic use also with:
Nosidło Basic używaj również z:





Wheelbox HD Trophy 1

Skrzynka narzędziowa na kółkach HD Trophy 1

710 (L) x 400 (W) x 355 (H) mm

515 (L) x 265 (W) x 270 (H) mm

COLOR	INDEX	EAN		
●	SKRWT1HDCZAPG001	5901238220879	15	3
●	SKRWT1HDCZEPG001	5901238220978	15	3
●	SKRWT1HDPOMPG001	5901238221074	15	3



Plastic wheels with rubber layer
Kółka z plastiku zabezpieczone warstwą gumy
Wheel Alu Handle
Alu rączka Wheel
HD Alu handle
Alu rączka HD
Metal latches
Metalowe zapięcia
Carriage
Nosidło
Anti-slip legs
Antypoślizgowe nóżki
Portable workshop
Mini warsztat

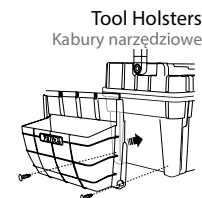



***Optional**
***Opcjonalnie**

Wheelbox HD Trophy 2

Skrzynka narzędziowa na kółkach HD Trophy 2

710 (L) x 400 (W) x 355 (H) mm

515 (L) x 265 (W) x 270 (H) mm

COLOR	INDEX	EAN		
●	SKRWT2HDCZAPG001	5901238220985	15	3
●	SKRWT2HDCZEPG001	5901238218616	15	3
●	SKRWT2HDPOMPG001	5901238221081	15	3



Plastic wheels with rubber layer
Kółka z plastiku zabezpieczone warstwą gumy
Wheel Alu Handle
Alu rączka Wheel
HD Alu handle
Alu rączka HD
Metal latches
Metalowe zapięcia
Carriage
Nosidło
Anti-slip legs
Antypoślizgowe nóżki
Portable workshop
Mini warsztat

Expert organizer
Organizer Expert



Tool Holders
Kabury narzędziowe

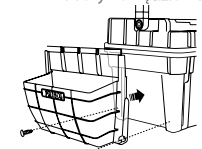



***Optional**
***Opcjonalnie**

Wheelbox HD Trophy 2 Carbo

Skrzynka narzędziowa na kółkach HD Trophy 2 Carbo

710 (L) x 400 (W) x 355 (H) mm

515 (L) x 265 (W) x 270 (H) mm

COLOR	INDEX	EAN		
●	SKRWT2HDCARCZAPG001	5901238245018	15	3
●	SKRWT2HDCARCZEPG001	5901238245025	15	3
●	SKRWT2HDCARPOMPG001	5901238245032	15	3



Plastic wheels with rubber layer
Kółka z plastiku zabezpieczone warstwą gumy
Wheel Alu Handle
Alu rączka Wheel
HD Alu handle
Alu rączka HD
Metal latches
Metalowe zapięcia
Carriage
Nosidło
Anti-slip legs
Antypoślizgowe nóżki
Portable workshop
Mini warsztat

Expert organizer
Organizer Expert



Tool Holders
Kabury narzędziowe

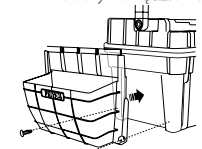

***Optional**
***Opcjonalnie**

WheelBox HD Compact

Skrzynka narzędziowa na kółkach HD Compact

Available colors
Dostępne kolory



Handle to pull with locking system
Rączka do ciągnięcia z systemem blokowania
Handle to lift
Rączka do podnoszenia

Strong polycarbonate organizers covers
Mocne poliwęglanowe pokrywy organizatorów

Metal latches
Metalowe zapięcia

Solid traction system with metal axle
Solidny system jezdny z metalową osią

Plastic wheels covered with a protective layer of rubber
Plastikowe koła pokryte zabezpieczającą warstwą gumy



Easy access
Łatwy dostęp



Ergobox 2 Plus on both sides
Ergobox 2 Plus po obu stronach



Tray
Tacka



4 x Portable Ergobox 2 Plus
4 x Wyjmowany Ergobox 2 Plus

Large tools container
Duży pojemnik na narzędzia



4 functional organizers
4 funkcjonalne organizery



Supporting slot
Szczelina pozycjonująca



Organizers covers impact resistant
Pokrywy organizatorów odporne na uderzenia



Lock handle
System blokowania rączki



Measure
Miarka

*tools not included/nie zawiera narzędzi

Wheelbox HD Compact

Skrzynka narzędziowa na kółkach HD Compact

495(L) x 360(W) x 710(H) mm

360 (L) x 315 (W) x 275 (H) mm

COLOR	INDEX	EAN		
●	SKRWC1HDCZAPG001	5901238224747	13	5



- Plastic wheels with rubber layer
Kółka z plastiku zabezpieczone warstwą gumy
- Metal Axle
Metalowa oś
- HD Handles
Rączki HD
- Metal latches
Metalowe zapięcia
- Polycarbonate organizers covers
Poliwęglanowe pokrywy organizatorów
- Deep tray
Głęboka taca
- 4 x ErgoBox 2 Plus
- 4 x ErgoBox 2 Plus
- 4 organizers on lid
4 organizery w pokrywie

Compact Module System

Skrzynka narzędziowa Compact Module System

450(L) x 350(W) x 450(H) mm

360 (L) x 300 (W) x 270 (H) mm

COLOR	INDEX	EAN		
●	SKRC1HDSMSCZAPG001	5901238225300	24	6



- HD Alu Handle
Alu rączka HD
- Metal latches
Metalowe zapięcia
- Deep tray
Głęboka taca
- Anti-slip legs
Antypoślizgowe nóżki
- Measure on the cover 40 cm
Miarka na pokrywie 40 cm

WheelBox HD Compact Logic

Skrzynka narzędziowa
na kółkach HD Compact Logic

Available colors
Dostępne kolory



Handle to pull with locking system
Rączka do ciągnięcia z systemem
blokowania

Handle to lift
Rączka do podnoszenia

Strong polycarbonate
organizers covers
Mocne poliwęglanowe
pokrywy organizerów

Metal latches
Metalowe zapięcia

Large tools container
Duży pojemnik na narzędzia

Plastic wheels covered with
a protective layer of rubber
Plastikowe koła pokryte
zabezpieczającą warstwą gumy

Tray
Tacka

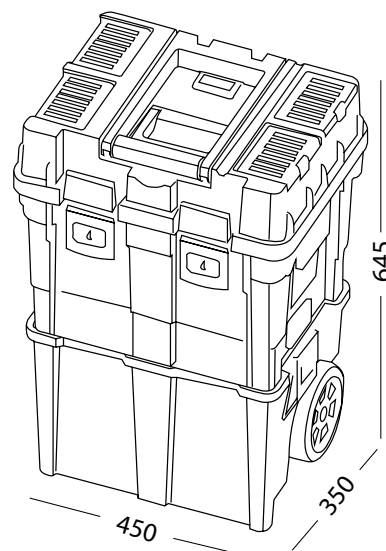

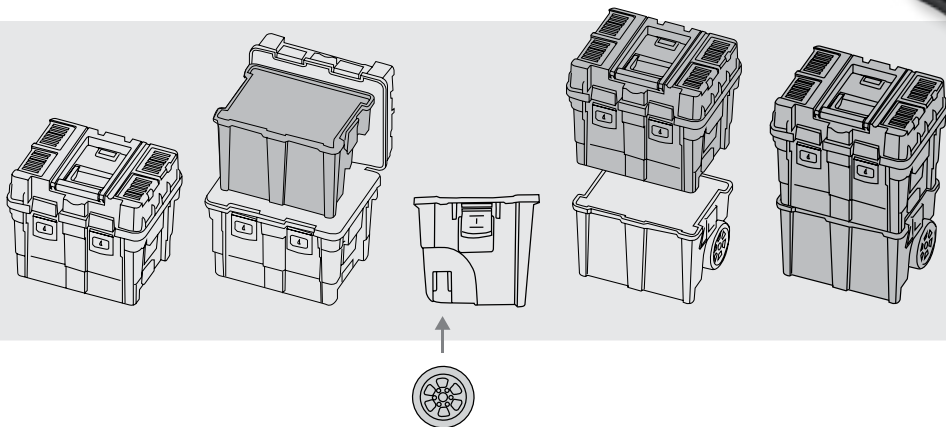



assemble
zmontowany

Wheelbox HD Compact Logic

Skrzynka narzędziowa na kółkach HD Compact Logic

450(L) x 350(W) x 645(H) mm

360 (L) x 300 (W) x 260 (H) mm + 340 (L) x 275 (W) x 270 (H) mm

COLOR	INDEX	EAN		
●	SKRWCLHDCZAPG001	5901238245100	18	6



- Plastic wheels with rubber layer
- Kółka z plastiku zabezpieczone warstwą gumy
- HD Handles
- Rączki HD
- Metal latches
- Metalowe zapięcia
- Polycarbonate organizers covers
- Poliwęglanowe pokrywy organizatorów
- Deep tray
- Głęboka tacka
- 4 organizers on lid
- 4 organizery w pokrywie





disassemble
rozmontowany

Wheelbox HD Compact Logic

Skrzynka narzędziowa na kółkach HD Compact Logic

450(L) x 350(W) x 390(H) mm

360 (L) x 300 (W) x 260 (H) mm

COLOR	INDEX	EAN		
●	SKRWCLHDCZAPG002	5901238245117	30	6



- Plastic wheels with rubber layer
- Kółka z plastiku zabezpieczone warstwą gumy
- HD Handles
- Rączki HD
- Metal latches
- Metalowe zapięcia
- Polycarbonate organizers covers
- Poliwęglanowe pokrywy organizatorów
- Deep tray
- Głęboka tacka
- 4 organizers on lid
- 4 organizery w pokrywie





Organizer HD 400 HD 600

Organizery HD

HD 400 are top organizers in offer of Patrol Group, which has a super solid construction - reinforced body, polycarbonate cover, anti-shock corners - ensures trouble-free operation even in the most extreme conditions. HD organizers (models with containers Combibox HD) allow for convenient storage and transportation of large and heavy accessories.

HD 400 to topowy organizer w ofercie Patrol Group, który dzięki super wytrzymałej konstrukcji - wzmocniony korpus, poliwęglanowa pokrywa, masywne narożniki - zapewnia bezproblemową eksploatację nawet w najbardziej ekstremalnych warunkach. Organizer HD 400 w wersji z pojemnikami Combibox HD pozwala na komfortowe przechowywanie i transport dużych i ciężkich akcesoriów.



Super solid polycarbonate cover. Super wytrzymała, poliwęglanowe pokrywy.

Organizer HD 400

Organizer HD 400
390(L) x 400(W) x 110(H) mm

INDEX	EAN		
ORGHD400CZAPG001	5901238224754	108	6



Polycarbonate cover
Poliwęglanowa pokrywa
Anti-shock Corners
Antywstrząsowe narożniki
Aluminum Latches
Aluminiowe zapięcia
12 x Combibox HD

Organizer HD 600

Organizer HD 600
390(L) x 600(W) x 110(H) mm

INDEX	EAN		
ORGHD600CZAPG001	5901238225119	72	4



Polycarbonate cover
Poliwęglanowa pokrywa
Anti-shock Corners
Antywstrząsowe narożniki
Aluminum Latches
Aluminiowe zapięcia
20 x Combibox HD

Organizer HD 400 MIX, HD 600 MIX

Organizery HD MIX

Organizer HD 400 MIX

Organizer HD 400 MIX
390(L) x 400(W) x 110(H) mm

INDEX	EAN		
ORGHD400MXCZAPG001	5901238243472	108	6



Polycarbonate cover
Poliwęglanowa pokrywa
Anti-shock Corners
Antywstrząsowe narożniki
Aluminum Latches
Aluminiowe zapięcia
8 x Combibox HD
+ 4x adjustable dividers
8 x Combibox HD
+ 4x regulowane przegrody

Organizer HD 600 MIX

Organizer HD 600 MIX
390(L) x 600(W) x 110(H) mm

INDEX	EAN		
ORGHD600MXCZAPG001	5901238243489	72	4



Polycarbonate cover
Poliwęglanowa pokrywa
Anti-shock Corners
Antywstrząsowe narożniki
Aluminum Latches
Aluminiowe zapięcia
8 x Combibox HD
+ 12x adjustable dividers
8 x Combibox HD
+ 12x regulowane przegrody



Organizer HD Flex 400 Flex 600

Organizery HD Flex



Super solid polycarbonate cover.
Super wytrzymałe, poliwęglanowe pokrywy.



Organizers **HD Flex** with adjustable dividers allow you to freely arrange storage space. With this solution, each user will be able to personalize the organizer under their individual needs.

Organizery **HD Flex** w wersji z regulowanymi przegrodami pozwalają na swobodne aranżowanie przestrzeni użytkowej. Dzięki takiemu rozwiązaniu, każdy użytkownik będzie mógł spersonalizować organizator pod swoje, indywidualne potrzeby.



Organizer HD Flex 400

Organizer HD 400 Flex
390(L) x 400(W) x 110(H) mm

INDEX	EAN		
ORGHD400FCZAPG001	5901238233381	108	6



Polycarbonate cover
Poliwęglanowa pokrywa
Anti-shock Corners
Antywstrząsowe narożniki
Aluminum Latches
Aluminiowe zapiecia
Adjustable dividers
Regulowane przegrody

Organizer HD Flex 600

Organizer HD 600 Flex
390(L) x 600(W) x 110(H) mm

INDEX	EAN		
ORGHD600FCZAPG001	5901238237600	72	4



Polycarbonate cover
Poliwęglanowa pokrywa
Anti-shock Corners
Antywstrząsowe narożniki
Aluminum Latches
Aluminiowe zapiecia
Adjustable dividers
Regulowane przegrody

*Adjustable dividers inserted loosely inside
Ruchome przegrody włożone luźno do organizera



HD Case

Pojemnik na
elektronarzędzia HD

Available colors
Dostępne kolory



Solid, double adjustable straps are made of a material with high impact strength. Strips allow you to protect tools from movement, and hence possible damage.

Solidne, obustronnie regulowane paski zostały wykonane z surowca o wysokiej wytrzymałości. Paski pozwalają zabezpieczyć narzędzia przed ruchem, a co za tym idzie możliwymi uszkodzeniami.



Reinforced ribs - extra ribs composed in cover significantly increase box durability.

Żebra wzmacniające – dodatkowe żebra znajdujące się w pokrywach znacząco podwyższają wytrzymałość skrzynki.



Protective foam layer on steel plate – protect tools against mechanical damages.

Gąbka ochronna na stalowej płycie – chroni narzędzia przed uszkodzeniami mechanicznymi.



Expert organizers – located on both sides of cover allow you to separate small accessories. That will let you find the elements you need much faster.

Organizery Expert – znajdujące się po obu stronach pokrywy umożliwiają posegregowanie drobnych akcesoriów i łatwiejszy do nich dostęp.



*tools not included/nie zawiera narzędzi





HD Case is a brand new quality among power tool boxes. Extraordinary durability thanks to additional ribs on covers. Steel plate with additional foam layer ensure safety of power tools located inside. Additionally to prevent the movement of the tools there are three safety straps of regulated length with solid clasps. HD case through its capacity and construction allows to carry both small and large power tools without any worries of causing damages.

HD CASE to zupełnie nowa jakość wśród pojemników na elektronarzędzia. Dzięki dodatkowemu żebrowaniu konstrukcja skrzynki jest bardzo wytrzymała. Wnętrze pojemnika jest wyposażone w stalową płytę oraz warstwę z pianki ochronnej, co pozwala na bezpieczne przechowywanie narzędzi. Dodatkowo, aby zapobiec przesuwaniu się narzędzi wewnątrz pojemnika zastosowane zostały trzy paski o regulowanej długości wraz z solidnymi klamrami. HD CASE ze względu na swoje gabaryty i konstrukcję pozwala na przenoszenie zarówno małych, jak i dużych elektronarzędzi bez obaw o ich uszkodzenie.

Powertool HD Case

Pojemnik na elektronarzędzia HD Case

600 (L) x 240(W) x 380(H) mm

COLOR	INDEX	EAN		
●	ELEKTROHDCZAPG001	5901238217916	32	4



Safety straps
Paski zabezpieczające
Protective foam
Gąbka ochronna
Steel plates
Płyta stalowa
Reinforced ribs
Żebra wzmacniające
Organizers x 2
Organizery x 2
Comfortable handle
Wygodna rączka

Powertool HD Case Carbo

Pojemnik na elektronarzędzia HD Case Carbo

600 (L) x 240(W) x 380(H) mm

COLOR	INDEX	EAN		
●	ELEKTROHDCARCZAPG001	5901238244868	32	4



Safety straps
Paski zabezpieczające
Protective foam
Gąbka ochronna
Steel plates
Płyta stalowa
Reinforced ribs
Żebra wzmacniające
Organizers x 2
Organizery x 2
Comfortable handle
Wygodna rączka



ToolBoxes

FORMULA

Skrzynki narzędziowe Formula

Formula boxes line consists of four series: Formula A, Formula S, RS, RS Flex, Carbo. There are three sizes of toolboxes: 500, 600 and 700. Common features for all are: modern design, workbench functionality while the cover is open and additional side handles. Formula A is a box in black color with silver clasps and black handle made of durable plastic. The cover has two organizers arranged on the sides. Formula S contain from two to three organizers depending on the size of the box. RS series has a large organizer with CombiBoxes in four sizes. Both S, RS and RS Flex toolboxes have specially designed handle which greatly increases their durability and use comfort. In addition, there is possibility to have aluminum clasps and double-level tray that significantly increase the functionality of the ToolBoxes.

Linie skrzynek Formula tworzą cztery serie: Formula A, Formula S, Formula RS, Formula RS Flex oraz Carbo. W każdej występują skrzynki w trzech rozmiarach 500, 600 oraz 700. Wspólnymi cechami dla wszystkich skrzynek z tej linii jest nowoczesny design, funkcjonalność stołu warsztatowego po otwarciu pokrywy oraz dodatkowe uchwyty boczne. Formula A to skrzynki w czarnych kolorach ze srebrnymi zapięciami i czarną rączką z wytrzymałego tworzywa. W pokrywie znajdują się dwa organizery ułożone po jej bokach. Formula S zawiera od dwóch do trzech organizatorów w zależności od wielkości skrzynki. Formula RS posiada jeden duży organizer z pojemnikami CombiBox w czterech rozmiarach. Wersje S, RS i RS Flex posiadają specjalnie zaprojektowane rączki co znacznie zwiększa ich wytrzymałość i komfort użytkowania. Dodatkowo w tych liniach występują aluminiowe zapięcia oraz dwupoziomowa tacka, które znacząco podwyższają wartość użytkową skrzynek.

ToolBoxes | **S** **FORMULA** **CARBO**

Skrzynki narzędziowe Formula S Carbo

Available colors

Dostępne kolory



CAPTION
LEGENDA

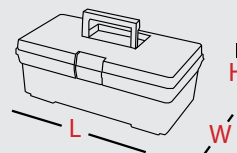

**Formula S
Organizers**

Organizery Formula S



**Padlock
hole**

Miejsce na kłódkę



**Super strong
covers**

Super wytrzymałe
pokrywy



**Aluminium
latches**

Aluminiowe zapięcia



Alu handle

Alumiowa rączka

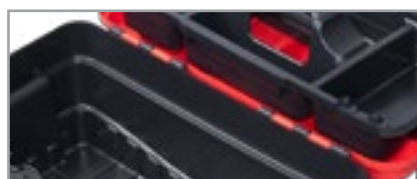

Mini tool table

Mini warsztat

FORMULA
CARBO





**POLYCARBONATE
POLIWĘGLAN**

ToolBox Formula S 500 Carbo



Skrzynka narzędziowa Formula S 500 Carbo

462 (L) x 256 (W) x 242 (H) mm

450 (L) x 230 (W) x 170 (H) mm

COLOR	INDEX	EAN		
	SKRS500FCARCZEPG001	5901238231998	56	7

* Optional colours

	SKRS500FCARCZAPG001	5901238242444	56	7
	SKRS500FCARNIEPG001	5901238232001	56	7
	SKRS500FCARPOMPG001	5901238231981	56	7

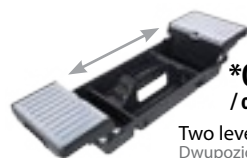

***Optional / opcjonalnie**

Two level tray
Dwupoziomowa tacka



Formula organizers
Organizery Formula



Formula Alu handle
Aluminiowa rączka Formula
Deep tray organizer with
sockets and bits storage

Głęboka tacka z otworami
na nasadki i bity

Side handles

Uchwyty boczne

Padlock hole

Miejsce na kłódkę

Portable workshop



Mini warsztat

ToolBox Formula S 600 Carbo



Skrzynka narzędziowa Formula S 600 Carbo

547 (L) x 271 (W) x 278 (H) mm

530 (L) x 250 (W) x 185 (H) mm

COLOR	INDEX	EAN		
	SKRS600FCARCZEPG001	5901238225218	42	6

* Optional colours

	SKRS600FCARCZAPG001	5901238242451	42	6
	SKRS600FCARNIEPG001	5901238225232	42	6
	SKRS600FCARPOMPG001	5901238225195	42	6

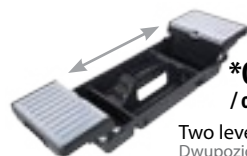

***Optional / opcjonalnie**

Two level tray
Dwupoziomowa tacka



Formula organizers
Organizery Formula



Formula Alu handle
Aluminiowa rączka Formula
Deep tray organizer with
sockets and bits storage

Głęboka tacka z otworami
na nasadki i bity

Side handles

Uchwyty boczne

Padlock hole

Miejsce na kłódkę

Portable workshop



Mini warsztat

ToolBox Formula S 700 Carbo



Skrzynka narzędziowa Formula S 700 Carbo

595 (L) x 289 (W) x 328 (H) mm

580 (L) x 270 (W) x 210 (H) mm

COLOR	INDEX	EAN		
	SKRS700FCARCZEPG001	5901238232049	36	6

* Optional colours

	SKRS700FCARCZAPG001	5901238242468	36	6
	SKRS700FCARNIEPG001	5901238232056	36	6
	SKRS700FCARPOMPG001	5901238232032	36	6

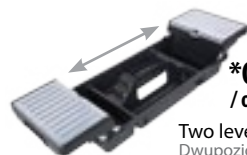

***Optional / opcjonalnie**

Two level tray
Dwupoziomowa tacka



Formula organizers
Organizery Formula



ToolBoxes | FORMULA RS CARBO

Skrzynki narzędziowe Formula RS Carbo

Available colors
Dostępne kolory



CAPTION
LEGENDA

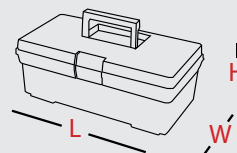

**Storage containers
inside the cover**
Wyjmowane pojemniki
w pokrywie



**Padlock
hole**

Miejsce na kłódkę



**Super strong
covers**
Super wytrzymałe
pokrywy



**Aluminium
latches**

Aluminiowe zapięcia



Alu handle
Alumiowa rączka



Mini tool table
Mini warsztat

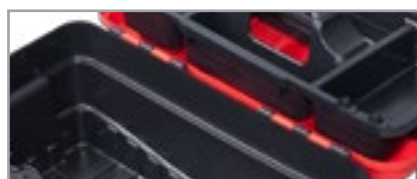

FORMULA
CARBO





POLYCARBONATE
POLIWĘGLAN

ToolBox Formula RS 500 Carbo

Skrzynka narzędziowa Formula RS 500 Carbo

↕ 462 (L) x 256 (W) x 242 (H) mm

⊞ 450 (L) x 230 (W) x 170 (H) mm

COLOR	INDEX	EAN		
	SKRRS500FCARCZEPG001	5901238232681	56	7

* Optional colours

	SKRRS500FCARCZAPG001	5901238242475	56	7
	SKRRS500FCARNIEPG001	5901238232698	56	7
	SKRRS500FCARPOMPG001	5901238232674	56	7

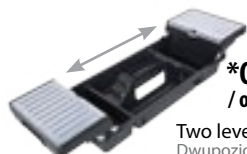

***Optional**
/opcjonalnie

Two level tray
Dwupoziomowa tacka



Formula Alu handle
Aluminiowa rączka Formula
Deep tray organizer with sockets and bits storage
Głęboka tacka z otworami na nasadki i bity
Side handles
Uchwyty boczne
Padlock hole
Miejsce na kłódkę
Portable workshop
Mini warsztat

CombiBoxes
CombiBoxes
Formula organizer
Organizer Formula





ToolBox Formula RS 600 Carbo



Skrzynka narzędziowa Formula RS 600 Carbo

↕ 547 (L) x 271 (W) x 278(H) mm

⊞ 530 (L) x 250 (W) x 185 (H) mm

COLOR	INDEX	EAN		
	SKRRS600FCARCZEPG001	5901238225294	42	6

* Optional colours

	SKRRS600FCARCZAPG001	5901238242482	42	6
	SKRRS600FCARNIEPG001	5901238225317	42	6
	SKRRS600FCARPOMPG001	5901238225270	42	6

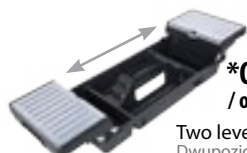

***Optional**
/opcjonalnie

Two level tray
Dwupoziomowa tacka



Formula Alu handle
Aluminiowa rączka Formula
Deep tray organizer with sockets and bits storage
Głęboka tacka z otworami na nasadki i bity
Side handles
Uchwyty boczne
Padlock hole
Miejsce na kłódkę
Portable workshop
Mini warsztat

CombiBoxes
CombiBoxes
Formula organizer
Organizer Formula





ToolBox Formula RS 700 Carbo

Skrzynka narzędziowa Formula RS 700 Carbo

↕ 595 (L) x 289 (W) x 328 (H) mm

⊞ 580 (L) x 270 (W) x 210 (H) mm

COLOR	INDEX	EAN		
	SKRRS700FCARCZEPG001	5901238232735	36	6

* Optional colours

	SKRRS700FCARCZAPG001	5901238242499	36	6
	SKRRS700FCARNIEPG001	5901238232742	36	6
	SKRRS700FCARPOMPG001	5901238232728	36	6

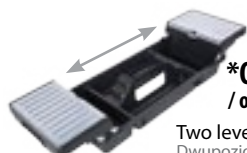

***Optional**
/opcjonalnie

Two level tray
Dwupoziomowa tacka



Formula Alu handle
Aluminiowa rączka Formula
Deep tray organizer with sockets and bits storage
Głęboka tacka z otworami na nasadki i bity
Side handles
Uchwyty boczne
Padlock hole
Miejsce na kłódkę
Portable workshop
Mini warsztat

CombiBoxes
CombiBoxes
Formula organizer
Organizer Formula



ToolBoxes | FORMULA RS CARBO Flex

Skrzynki narzędziowe Formula RS Carbo Flex

Available colors
Dostępne kolory



CAPTION
LEGENDA

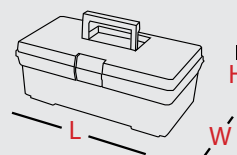

**Adjustable
dividers**
Regulowane
przegrody





**Padlock
hole**
Miejsce na kłódkę

**Super strong
covers**
Super wytrzymałe
pokrywy

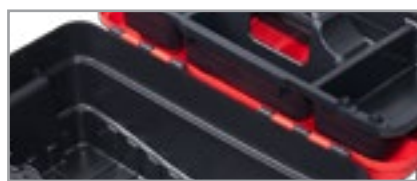
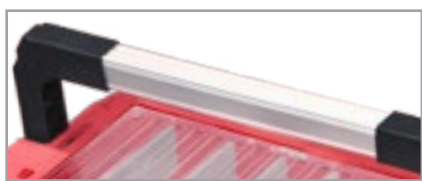

**Aluminium
latches**
Aluminiowe zapięcia

Alu handle
Alumiowa rączka



Mini tool table
Mini warsztat

**FORMULA
CARBO**

**POLYCARBONATE
POLIWĘGLAN**

ToolBox Formula RS 500 Carbo Flex

Skrzynka narzędziowa Formula RS 500 Carbo Flex

462 (L) x 256 (W) x 242 (H) mm

450 (L) x 230 (W) x 170 (H) mm

COLOR INDEX EAN  

 SKRRS500FCAFCZEPG001 5901238238041 56 7

* Optional colours

 SKRRS500FCAFCZAPG001 5901238242505 56 7

 SKRRS500FCAFNIEPG001 5901238237426 56 7

 SKRRS500FCAFPOMPG001 5901238238058 56 7

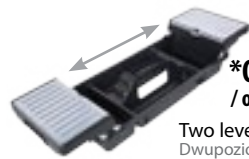

***Optional**
/ opcjonalnie

Two level tray
Dwupoziomowa tacka



Formula Alu handle
Aluminowa rączka Formula
Deep tray organizer with sockets and bits storage
Głęboka tacka z otworami na nasadki i bity
Side handles
Uchwyty boczne
Padlock hole
Miejsce na kłódkę
Portable workshop
Mini warsztat

Formula organizer
Organizer Formula



ToolBox Formula RS 600 Carbo Flex

Skrzynka narzędziowa Formula RS 600 Carbo Flex

547 (L) x 271 (W) x 278(H) mm

530 (L) x 250 (W) x 185 (H) mm

COLOR INDEX EAN  

 SKRRS600FCAFCZEPG001 5901238238065 42 6

* Optional colours

 SKRRS600FCAFCZAPG001 5901238242512 42 6

 SKRRS600FCAFNIEPG001 5901238236993 42 6

 SKRRS600FCAFPOMPG001 5901238238072 42 6

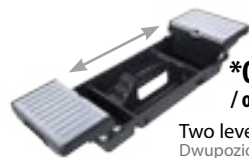

***Optional**
/ opcjonalnie

Two level tray
Dwupoziomowa tacka



Formula Alu handle
Aluminowa rączka Formula
Deep tray organizer with sockets and bits storage
Głęboka tacka z otworami na nasadki i bity
Side handles
Uchwyty boczne
Padlock hole
Miejsce na kłódkę
Portable workshop
Mini warsztat

Formula organizer
Organizer Formula





ToolBox Formula RS 700 Carbo Flex

Skrzynka narzędziowa Formula RS 700 Carbo Flex

595 (L) x 289 (W) x 328 (H) mm

580 (L) x 270 (W) x 210 (H) mm

COLOR INDEX EAN  

 SKRRS700FCAFCZEPG001 5901238237044 36 6

* Optional colours

 SKRRS700FCAFCZAPG001 5901238242529 36 6

 SKRRS700FCAFNIEPG001 5901238237020 36 6

 SKRRS700FCAFPOMPG001 5901238237037 36 6

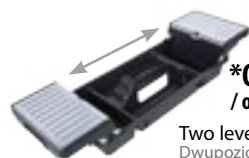

***Optional**
/ opcjonalnie

Two level tray
Dwupoziomowa tacka



Formula Alu handle
Aluminowa rączka Formula
Deep tray organizer with sockets and bits storage
Głęboka tacka z otworami na nasadki i bity
Side handles
Uchwyty boczne
Padlock hole
Miejsce na kłódkę
Portable workshop
Mini warsztat

Formula organizer
Organizer Formula





CAPTION
LEGENDA

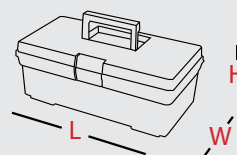

ToolBoxes | FORMULA | A

Skrzynki narzędziowe Formula A

Available colors
Dostępne kolory



Deep tray – with a comfortable handle. Small storage containers fit in its compartments perfectly, which facilitates the arrangement of accessories such as screws and nuts.

Głęboka tacka - z wygodną rączką. Do przegród, w które jest wyposażona, idealnie pasują niewielkie pojemniki magazynowe, ułatwiające posegregowanie akcesoriów takich jak śruby, czy nakrętki.



Transparent cover – helps to find quickly necessary elements.

Transparentna pokrywa - umożliwia bardzo szybkie odszukanie potrzebnych elementów.



Tray organizer with sockets and bits storage.

Tacka z otworami na nasadki i bity.



Solid plastic latches.

Solidne plastikowe zapięcia.



Basic handle – one-compartment handle, allowing for comfortable transport of the box.

Rączka Basic - prosty, jednokomorowy uchwyt, dzięki któremu można wygodnie przetransportować skrzynkę.



*tools not included/ nie zawiera narzędzi

ToolBox Formula A 300

Skrzynka narzędziowa Formula A 300

↔ 374 (L) x 198 (W) x 189 (H) mm

↕ 320 (L) x 150 (W) x 145 (H) mm

COLOR	INDEX	EAN		
●	SKRA300FCZAPG001	5901238221289	140	14



Deep tray organizer with sockets and bits storage

Głęboka tacka z otworami na nasadki i bity

Side handles

Uchwyty boczne

Formula organizers



Organizery Formula

ToolBox Formula A 500

Skrzynka narzędziowa Formula A 500

↔ 462 (L) x 256 (W) x 242 (H) mm

↕ 450 (L) x 230 (W) x 170 (H) mm

COLOR	INDEX	EAN		
●	SKRA500FCZAPG001	5901238209195	56	7

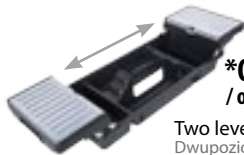

***Optional / opcjonalnie**

Two level tray
Dwupoziomowa tacka



Deep tray organizer with sockets and bits storage

Głęboka tacka z otworami na nasadki i bity

Side handles

Uchwyty boczne

Padlock hole

Miejsce na kłódkę

Formula organizers

Organizery Formula





ToolBox Formula A 600

Skrzynka narzędziowa Formula A 600

↔ 547 (L) x 271 (W) x 278 (H) mm

↕ 530 (L) x 250 (W) x 185 (H) mm

COLOR	INDEX	EAN		
●	SKRA600FCZAPG001	5901238209201	42	6

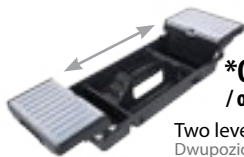

***Optional / opcjonalnie**

Two level tray
Dwupoziomowa tacka



Deep tray organizer with sockets and bits storage

Głęboka tacka z otworami na nasadki i bity

Side handles

Uchwyty boczne

Padlock hole

Miejsce na kłódkę

Formula organizers

Organizery Formula





ToolBox Formula A 700

Skrzynka narzędziowa Formula A 700

↔ 595 (L) x 289 (W) x 328 (H) mm

↕ 580 (L) x 270 (W) x 210 (H) mm

COLOR	INDEX	EAN		
●	SKRA700FCZAPG001	5901238209218	36	6



Deep tray organizer with sockets and bits storage

Głęboka tacka z otworami na nasadki i bity

Side handles

Uchwyty boczne

Padlock hole

Miejsce na kłódkę

Formula organizers

Organizery Formula





CAPTION
LEGENDA

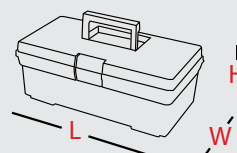

ToolBoxes | FORMULA | S

Skrzynki narzędziowe Formula S

Available colors

Dostępne kolory



Formula Alu handle.

Aluminiowa rączka Formula.



Deep tray or tray Plus – large, two level handy tray with a comfortable handle.

Głęboka jedno- lub dwupoziomowa tacka Plus - duża dwupoziomowa, poręczna tacka z wygodną rączką.



Formula organizer – it allows you to separate small accessories, in this way, you can find the elements you need quickly.

Organizer Formula - umożliwia posegregowanie drobnych akcesoriów, dzięki czemu zdecydowanie szybciej można odszukać potrzebne elementy.



Padlock hole – special padlock hole in the box can be used to protect your tools against theft.

Miejsce na kłódkę specjalnie wykonany otwór w skrzynce, umożliwia zabezpieczenie magazynowanych narzędzi przed kradzieżą.



Side handles – help you to carry ToolBox filled with heavy tools.

Uchwyty boczne - ułatwiają przenoszenie wypełnionej ciężkimi narzędziami skrzynki.



Portable workshop – thanks to specially made handle, you can transform your box into a mini tool table.

Mini warsztat - dzięki specjalnie wykonanemu uchwytowi, możliwa jest przemiana skrzynki w mini stół narzędziowy.



Alu latches – made of anodized aluminium.

Zapięcia Alu - wykonane z anodowanego aluminium.



*tools not included/nie zawiera narzędzi

ToolBox Formula S 500

Skrzynka narzędziowa Formula S 500

462 (L) x 256 (W) x 242 (H) mm

450 (L) x 230 (W) x 170 (H) mm

COLOR	INDEX	EAN		
●	SKRS500FRCCZAPG001	5901238242697	56	7

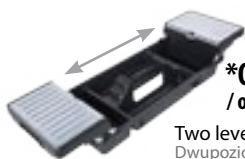

***Optional / opcjonalnie**
Two level tray
Dwupoziomowa tacka



Formula steel handle
Stalowa rączka Formula
Deep tray organizer with sockets and bits storage
Głęboka tacka z otworami na nasadki i bity
Side handles
Uchwyty boczne
Padlock hole
Miejsce na kłódkę
Portable workshop
Mini warsztat

Formula organizers
Organizery Formula





ToolBox Formula S 600

Skrzynka narzędziowa Formula S 600

547 (L) x 271 (W) x 278 (H) mm

530 (L) x 250 (W) x 185 (H) mm

COLOR	INDEX	EAN		
●	SKRS600FRCCZAPG001	5901238242703	42	6

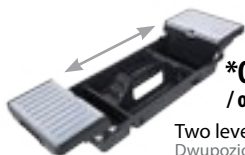

***Optional / opcjonalnie**
Two level tray
Dwupoziomowa tacka



Formula steel handle
Stalowa rączka Formula
Deep tray organizer with sockets and bits storage
Głęboka tacka z otworami na nasadki i bity
Side handles
Uchwyty boczne
Padlock hole
Miejsce na kłódkę
Portable workshop
Mini warsztat

Formula organizers
Organizery Formula





ToolBox Formula S 700

Skrzynka narzędziowa Formula S 700

595 (L) x 289 (W) x 328 (H) mm

580 (L) x 270 (W) x 210 (H) mm

COLOR	INDEX	EAN		
●	SKRS700FRCCZAPG001	5901238242710	36	6

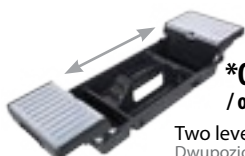

***Optional / opcjonalnie**
Two level tray
Dwupoziomowa tacka



Formula steel handle
Stalowa rączka Formula
Deep tray organizer with sockets and bits storage
Głęboka tacka z otworami na nasadki i bity
Side handles
Uchwyty boczne
Padlock hole
Miejsce na kłódkę
Portable workshop
Mini warsztat

Formula organizers
Organizery Formula





ToolBoxes

STUFF

Skrzynki narzędziowe Stuff

Modern look and solid manufacture are the main features of Patrol Group's Stuff line of toolboxes. Extra ribs composed in cover significantly increase their durability. Each toolbox possess large and handy tray with a comfortable handle. Small storage containers fit in its compartments perfectly, which facilitates the arrangement of accessories such as screws and nuts. Specially designed latches position themselves to prevent improper locking.

Linia skrzynek Stuff to nowoczesność oraz solidne wykonanie. Dodatkowe żebra znajdujące się w pokrywach znacząco podwyższają ich wytrzymałość. Każda ze skrzynek posiada tackę z przestronnymi komorami oraz miejscem na bity, a specjalnie zaprojektowane zapięcia pozycjonują się, zapobiegając nieprawidłowemu zamknięciu.

CAPTION
LEGENDA

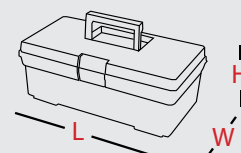

ToolBoxes STUFF CARBO

Skrzynki narzędziowe Stuff Carbo

Available colors
Dostępne kolory



ALUMINUM
LATCHES
ALUMINIOWE
ZAPIĘCIA



PADLOCK
HOLE
MIEJSCE
NA KŁÓDKĘ



SUPER STRONG
COVERS
SUPER WYTRZYMAŁE
POKRYTY



ADJUSTABLE
DIVIDERS
REGULOWANE
PRZEGRODY



STUFF
CARBO



POLYCARBONATE
POLIWĘGLAN









ToolBox Stuff Semi Profi 12 Carbo

Skrzynka narzędziowa Stuff Semi Profi 12

312 (L) x 167 (W) x 130 (H) mm

305 (L) x 150 (W) x 100 (H) mm

COLOR	INDEX	EAN		
	SKR12SPSCARZOLPG001	5901238233121	300	20
* Optional colours				
	SKR12SPSCARCZAPG001	5901238242628	300	20
	SKR12SPSCARNIEPG001	5901238242581	300	20
	SKR12SPSCARCZEPG001	5901238242543	300	20
	SKR12SPSCARPOMPG001	5901238242574	300	20



Stuff handle
Rączka Stuff
Stuff clasps
Zapięcia Stuff
Deep tray organizer with sockets and bits storage
Głęboka tacka z otworami na nasadki i bity
Side handles
Uchwyty boczne
2 Stuff organizers
2 Organizery Stuff









ToolBox Stuff Semi Profi 16 Carbo

Skrzynka narzędziowa Stuff Semi Profi 16

415 (L) x 226 (W) x 200 (H) mm

405 (L) x 205 (W) x 145 (H) mm

COLOR	INDEX	EAN		
	SKR16SPSCARZOLPG001	5901238233138	120	12
* Optional colours				
	SKR16SPSCARCZAPG001	5901238242635	120	12
	SKR16SPSCARNIEPG001	5901238242598	120	12
	SKR16SPSCARCZEPG001	5901238233893	120	12
	SKR16SPSCARPOMPG001	5901238238195	120	12



Stuff handle
Rączka Stuff
Stuff clasps
Zapięcia Stuff
Deep tray organizer with sockets and bits storage
Głęboka tacka z otworami na nasadki i bity
Padlock hole
Miejsce na kłódkę
Side handles
Uchwyty boczne
2 Stuff organizers
2 Organizery Stuff



ToolBox Stuff Semi Profi 20 Carbo

Skrzynka narzędziowa Stuff Semi Profi 20

525 (L) x 256 (W) x 246 (H) mm

510 (L) x 235 (W) x 190 (H) mm

COLOR	INDEX	EAN		
	SKR20SPSCARZOLPG001	5901238233145	56	7
* Optional colours				
	SKR20SPSCARCZAPG001	5901238242642	56	7
	SKR20SPSCARNIEPG001	5901238242604	56	7
	SKR20SPSCARCZEPG001	5901238242550	56	7
	SKR20SPSCARPOMPG001	5901238238201	56	7



Stuff handle
Rączka Stuff
Stuff clasps
Zapięcia Stuff
Deep tray organizer with sockets and bits storage
Głęboka tacka z otworami na nasadki i bity
Padlock hole
Miejsce na kłódkę
Side handles
Uchwyty boczne
4 Stuff organizers
4 Organizery Stuff



ToolBox Stuff Semi Profi 26 Carbo

Skrzynka narzędziowa Stuff Semi Profi 26

595 (L) x 337 (W) x 316 (H) mm

580 (L) x 315 (W) x 245 (H) mm

COLOR	INDEX	EAN		
	SKR26SPSCARZOLPG001	5901238233152	24	4
* Optional colours				
	SKR26SPSCARCZAPG001	5901238242659	24	4
	SKR26SPSCARNIEPG001	5901238242611	24	4
	SKR26SPSCARCZEPG001	5901238242567	24	4
	SKR26SPSCARPOMPG001	5901238238218	24	4



Stuff handle
Rączka Stuff
Stuff clasps
Zapięcia Stuff
Deep tray organizer with sockets and bits storage
Głęboka tacka z otworami na nasadki i bity
Padlock hole
Miejsce na kłódkę
Side handles
Uchwyty boczne
6 Stuff organizers
6 Organizery Stuff

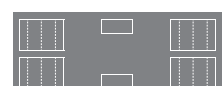

STUFF Module System Carbo

Skrzynki Narzędziowe
Stuff Module System Carbo

Available colors
Dostępne kolory

CAPTION
LEGENDA

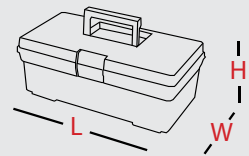

ErgoBox 2 Plus x3

Ergobox Plus is a multi-purpose containers, which in combination with the box STUFF is the perfect modul for storing tools and workshop accessories.

ErgoBox Plus to wielofunkcyjne pojemniki, które w połączeniu ze skrzynką STUFF tworzą idealny modul do przechowywania narzędzi i akcesoriów warsztatowych.

Stuff organizers – allow to storage and ensure easy access to small elements.

Organizery Stuff – pozwalają na magazynowanie i łatwy dostęp do drobnych elementów.



ToolBox Stuff Module System Semi Profi Carbo





Skrzynka narzędziowa Stuff Module System Semi Profi Carbo

↕ 525 (L) x 256 (W) x 325 (H) mm

↔ 510 (L) x 235 (W) x 190 (H) mm

COLOR	INDEX	EAN		
	SKR20SPSMSCAZOLPG001	5901238242406	42	7

* Optional colours

	SKR20SPSMSCACZAPG001	5901238242666	42	7
	SKR20SPSMSCANIEPG001	5901238242680	42	7
	SKR20SPSMSCACZEPG001	5901238242673	42	7
	SKR20SPSMSCAPOMPG001	5901238239918	42	7





CAPTION
LEGENDA

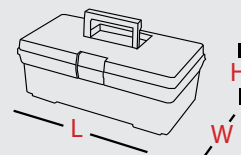

ToolBoxes STUFF

Skrzynki narzędziowe Stuff

Available colors
Dostępne kolory



Deep tray with a comfortable handle. Small storage containers fit in its compartments perfectly, which facilitates the arrangement of accessories such as screws and nuts.

Głęboka tacka z wygodną rączką. Do przegród, w które jest wyposażona, idealnie pasują niewielkie pojemniki magazynowe, ułatwiające posegregowanie akcesoriów takich jak śruby, czy nakrętki.



Padlock hole – special hole in the box can be used to protect your tools against theft.

Miejsce na kłódkę – specjalnie wykonany otwór w skrzynce, umożliwia zabezpieczenie magazynowanych narzędzi.



Reinforced pins – made of durable plastic prevent breakage of the hinges.

Wzmocnione trzpienie – wykonane z wytrzymałego tworzywa zapobiegają uszkodzeniu zawiasów.



Stuff latches - specially designed, position themselves to prevent improper locking.

Zapięcia Stuff - specjalnie zaprojektowane, pozycjonują się zapobiegając nieprawidłowemu zamknięciu.

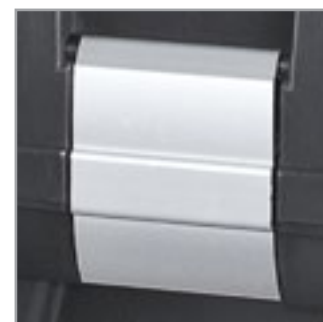

Stuff Alu latches - specially designed, position themselves to prevent improper locking.

Zapięcia Stuff Alu - specjalnie zaprojektowane, pozycjonują się zapobiegając nieprawidłowemu zamknięciu.

*tools not included/nie zawiera narzędzi

6 organizers
on the cover of
Stuff 26 Semi Profi
6 organizatorów
w pokrywie
Stuff 26 Semi Profi



Adjustable compartments
Regulowane przegrody



Space saving
packing
Ekonomiczne
pakowanie



Stuff handle – ensures comfortable
and safe grip during carriage.

Rączka Stuff – zapewnia komfortowy
i pewny chwyt podczas noszenia.



Side handles – help you to carry
boxes filled with heavy tools.

Uchwyty boczne – ułatwiają
przenoszenie wypełnionej ciężkimi
narzędziami skrzynki.



Reinforced ribs - composed in cover
significantly increase box durability.

Żebra wzmacniające – znajdujące
się w pokrywach znacząco
podwyższają wytrzymałość skrzynki.



Stuff Organizers – allow to storage
and ensure easy access to small
elements.

Organizery Stuff – pozwalają na
magazynowanie i łatwy dostęp do
drobnych elementów.

*tools not included/nie zawiera narzędzi

ToolBox Stuff 16 Optimo P

Skrzynka narzędziowa Stuff 16 Optimo P

↔ 415 (L) x 226 (W) x 181 (H) mm

↕ 405 (L) x 205 (W) x 145 (H) mm

COLOR INDEX

EAN



● SKR16PSTUOCZAPG001 5901238243014 132 12



Stuff handle
Rączka Stuff
Stuff clasps
Zapięcia Stuff
Tray
Pół-tacka
Side handles
Uchwyty boczne
2 organizers
2 Organizery

ToolBox Stuff 20 Optimo P

Skrzynka narzędziowa Stuff 20 Optimo P

↔ 525 (L) x 256 (W) x 225 (H) mm

↕ 510 (L) x 235 (W) x 190 (H) mm

COLOR INDEX

EAN



● SKR20PSTUOCZAPG001 5901238243021 63 7



Stuff handle
Rączka Stuff
Stuff clasps
Zapięcia Stuff
Tray
Pół-tacka
Padlock hole
Miejsce na kłódkę
Side handles
Uchwyty boczne
2 organizers
2 Organizery

ToolBox Stuff Module System Optimo P

Skrzynka narzędziowa Stuff Module System Optimo P

↔ 525 (L) x 256 (W) x 305 (H) mm

↕ 510 (L) x 235 (W) x 190 (H) mm

COLOR INDEX

EAN



● SKR20PSMSOCZAPG001 5901238244257 42 7



Stuff handle
Rączka Stuff
Stuff clasps
Zapięcia Stuff
Tray
Pół-tacka
Padlock hole
Miejsce na kłódkę
Side handles
Uchwyty boczne
2 organizers
2 Organizery

ToolBox Stuff 12 Optimo B

Skrzynka narzędziowa Stuff 12 Optimo B

↕ 312(L) x 167 (W) x 130 (H) mm

⊞ 305 (L) x 150 (W) x 100 (H) mm

COLOR INDEX

EAN



● SKR12BSTUOCZAPG001 5901238244172 300 20



Stuff handle
Rączka Stuff
Stuff clasps
Zapięcia Stuff
Side handles
Uchwyty boczne

ToolBox Stuff 16 Optimo B

Skrzynka narzędziowa Stuff 16 Optimo B

↕ 415(L) x 226 (W) x 181 (H) mm

⊞ 405 (L) x 205 (W) x 145 (H) mm

COLOR INDEX

EAN

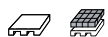

● SKR16BSTUOCZAPG001 5901238244127 120 12



Stuff handle
Rączka Stuff
Stuff clasps
Zapięcia Stuff
Tray
Pół-tacka
Padlock hole
Miejsce na klódkę
Side handles
Uchwyty boczne

ToolBox Stuff 20 Optimo B

Skrzynka narzędziowa Stuff 20 Optimo B

↕ 525 (L) x 256 (W) x 225 (H) mm

⊞ 510 (L) x 235 (W) x 190 (H) mm

COLOR INDEX

EAN



● SKR20BSTUOCZAPG001 5901238244110 56 7



Stuff handle
Rączka Stuff
Stuff clasps
Zapięcia Stuff
Tray
Pół-tacka
Padlock hole
Miejsce na klódkę
Side handles
Uchwyty boczne

ToolBox Stuff 26 Optimo B

Skrzynka narzędziowa Stuff 26 Optimo B

↕ 595 (L) x 337 (W) x 316 (H) mm

⊞ 580 (L) x 315 (W) x 245 (H) mm

COLOR INDEX

EAN



● SKR26BSTUOCZAPG001 5901238244134 24 4



Stuff handle
Rączka Stuff
Stuff clasps
Zapięcia Stuff
Tray
Pół-tacka
Padlock hole
Miejsce na klódkę
Side handles
Uchwyty boczne

ToolBox Stuff Module System Optimo B

Skrzynka narzędziowa Stuff Module System Optimo B

↕ 525 (L) x 256 (W) x 325 (H) mm

⊞ 510 (L) x 235 (W) x 190 (H) mm

COLOR INDEX

EAN



● SKR20BSMOCZAPG001 5901238244240 42 7



Stuff handle
Rączka Stuff
Stuff clasps
Zapięcia Stuff
Tray
Pół-tacka
Padlock hole
Miejsce na klódkę
Side handles
Uchwyty boczne

ToolBox Stuff 12 Optimo SP

Skrzynka narzędziowa Stuff 12 Optimo B

312(L) x 167 (W) x 130 (H) mm

305 (L) x 150 (W) x 100 (H) mm

COLOR INDEX EAN



● SKR12SPSTUOCZAPG001 5901238244189 300 20



Stuff handle
Rączka Stuff
Stuff clasps
Zapięcia Stuff
Side handles
Uchwyty boczne
2 Stuff organizers
2 Organizery Stuff



ToolBox Stuff 16 Optimo SP

Skrzynka narzędziowa Stuff 16 Optimo SP

415(L) x 226 (W) x 200 (H) mm

405 (L) x 205 (W) x 145 (H) mm

COLOR INDEX EAN



● SKR16SPSTUOCZAPG001 5901238244073 120 12



Stuff handle
Rączka Stuff
Stuff clasps
Zapięcia Stuff
Tray
Pół-tacka
Padlock hole
Miejsce na kłódkę
Side handles
Uchwyty boczne
2 Stuff organizers
2 Organizery Stuff



ToolBox Stuff 20 Optimo SP

Skrzynka narzędziowa Stuff 20 Optimo SP

525 (L) x 256 (W) x 246 (H) mm

510 (L) x 235 (W) x 190 (H) mm

COLOR INDEX EAN



● SKR20SPSTUOCZAPG001 5901238244066 56 7



Stuff handle
Rączka Stuff
Stuff clasps
Zapięcia Stuff
Tray
Pół-tacka
Padlock hole
Miejsce na kłódkę
Side handles
Uchwyty boczne
4 Stuff organizers
4 Organizery Stuff



ToolBox Stuff 26 Optimo SP

Skrzynka narzędziowa Stuff 26 Optimo SP

595 (L) x 337 (W) x 316 (H) mm

580 (L) x 315 (W) x 245 (H) mm

COLOR INDEX EAN



● SKR26SPSTUOCZAPG001 5901238244103 24 4



Stuff handle
Rączka Stuff
Stuff clasps
Zapięcia Stuff
Tray
Pół-tacka
Padlock hole
Miejsce na kłódkę
Side handles
Uchwyty boczne
6 Stuff organizers
6 Organizery Stuff



ToolBox Stuff Module System Optimo SP

Skrzynka narzędziowa Stuff Module System Optimo SP

525 (L) x 337 (W) x 316 (H) mm

510 (L) x 235 (W) x 190 (H) mm

COLOR INDEX EAN



● SKR20SPSMSOCZAPG001 5901238244264 42 7



Stuff handle
Rączka Stuff
Stuff clasps
Zapięcia Stuff
Tray
Pół-tacka
Padlock hole
Miejsce na kłódkę
Side handles
Uchwyty boczne
3x Ergobox 2 Plus



ToolBox Stuff Basic 12

Skrzynka narzędziowa Stuff Basic 12

312(L) x 167 (W) x 130 (H) mm

305 (L) x 150 (W) x 100 (H) mm

COLOR INDEX

EAN

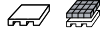

● SKR12BSTUFFCZAPG001 5901238215219 300 20



Stuff handle
Rączka Stuff
Stuff clasps
Zapięcia Stuff
Deep tray organizer with
sockets and bits storage
Głęboka tacka z otworami
na nasadki i bity
Side handles
Uchwyty boczne

ToolBox Stuff Basic 16

Skrzynka narzędziowa Stuff Basic 16

415(L) x 226 (W) x 200 (H) mm

405 (L) x 205 (W) x 145 (H) mm

COLOR INDEX

EAN



● SKR16BSTUFFCZAPG001 5901238215226 120 12



Stuff handle
Rączka Stuff
Stuff clasps
Zapięcia Stuff
Deep tray organizer with
sockets and bits storage
Głęboka tacka z otworami
na nasadki i bity
Padlock hole
Miejsce na kłódkę
Side handles
Uchwyty boczne

ToolBox Stuff Basic 20

Skrzynka narzędziowa Stuff Basic 20

525 (L) x 256 (W) x 246 (H) mm

510 (L) x 235 (W) x 190 (H) mm

COLOR INDEX

EAN



● SKR20BSTUFFCZAPG001 5901238214519 56 7



Stuff handle
Rączka Stuff
Stuff clasps
Zapięcia Stuff
Deep tray organizer with
sockets and bits storage
Głęboka tacka z otworami
na nasadki i bity
Padlock hole
Miejsce na kłódkę
Side handles
Uchwyty boczne

ToolBox Stuff Basic 26

Skrzynka narzędziowa Stuff Basic 26

595 (L) x 337 (W) x 316 (H) mm

580 (L) x 315 (W) x 245 (H) mm

COLOR INDEX

EAN



● SKR26BSTUFFCZAPG001 5901238215233 24 4



Stuff handle
Rączka Stuff
Stuff clasps
Zapięcia Stuff
Deep tray organizer with
sockets and bits storage
Głęboka tacka z otworami
na nasadki i bity
Padlock hole
Miejsce na kłódkę
Side handles
Uchwyty boczne

ToolBox Stuff Basic Alu 16

Skrzynka narzędziowa Stuff Basic Alu 16

415 (L) x 226 (W) x 200 (H) mm

405 (L) x 205 (W) x 145 (H) mm

COLOR INDEX

EAN



● SKR16BALSTUCZAPG001 5901238221500 120 12



Stuff handle
Rączka Stuff
Stuff Alu clasps
Zapięcia Stuff Alu
Deep tray organizer with
sockets and bits storage
Głęboka tacka z otworami
na nasadki i bity
Padlock hole
Miejsce na kłódkę
Side handles
Uchwyty boczne

ToolBox Stuff Basic Alu 20

Skrzynka narzędziowa Stuff Basic Alu 20

525 (L) x 256 (W) x 246 (H) mm

510 (L) x 235 (W) x 190 (H) mm

COLOR INDEX

EAN



● SKR20BALSTUCZAPG001 5901238221517 56 7



Stuff handle
Rączka Stuff
Stuff Alu clasps
Zapięcia Stuff Alu
Deep tray organizer with
sockets and bits storage
Głęboka tacka z otworami
na nasadki i bity
Padlock hole
Miejsce na kłódkę
Side handles
Uchwyty boczne

ToolBox Stuff Basic Alu 26

Skrzynka narzędziowa Stuff Basic Alu 26

595 (L) x 337 (W) x 316 (H) mm

580 (L) x 315 (W) x 245 (H) mm

COLOR INDEX

EAN



● SKR26BALSTUCZAPG001 5901238221524 24 4



Stuff handle
Rączka Stuff
Stuff Alu clasps
Zapięcia Stuff Alu
Deep tray organizer with
sockets and bits storage
Głęboka tacka z otworami
na nasadki i bity
Padlock hole
Miejsce na kłódkę
Side handles
Uchwyty boczne

ToolBox Stuff Semi Profi 12

Skrzynka narzędziowa Stuff Semi Profi 12

312(L) x 167 (W) x 130 (H) mm

305 (L) x 150 (W) x 100 (H) mm

COLOR INDEX EAN  

● SKR12SPSTUFFCZAPG001 5901238215189 300 20



Stuff handle
Rączka Stuff
Stuff clasps
Zapięcia Stuff
Deep tray organizer with
sockets and bits storage
Głęboka tacka z otworami
na nasadki i bity
Side handles
Uchwyty boczne
2 Stuff organizers
2 Organizery Stuff



ToolBox Stuff Semi Profi 16

Skrzynka narzędziowa Stuff Semi Profi 16

415(L) x 226 (W) x 200 (H) mm

405 (L) x 205 (W) x 145 (H) mm

COLOR INDEX EAN  

● SKR16SPSTUFFCZAPG001 5901238215196 120 12



Stuff handle
Rączka Stuff
Stuff clasps
Zapięcia Stuff
Deep tray organizer with
sockets and bits storage
Głęboka tacka z otworami
na nasadki i bity
Padlock hole
Miejsce na kłódkę
Side handles
Uchwyty boczne
2 Stuff organizers
2 Organizery Stuff



ToolBox Stuff Semi Profi 20

Skrzynka narzędziowa Stuff Semi Profi 20

525 (L) x 256 (W) x 246 (H) mm

510 (L) x 235 (W) x 190 (H) mm

COLOR INDEX EAN  

● SKR20SPSTUFFCZAPG001 5901238214618 56 7



Stuff handle
Rączka Stuff
Stuff clasps
Zapięcia Stuff
Deep tray organizer with
sockets and bits storage
Głęboka tacka z otworami
na nasadki i bity
Padlock hole
Miejsce na kłódkę
Side handles
Uchwyty boczne
4 Stuff organizers
4 Organizery Stuff



ToolBox Stuff Semi Profi 26

Skrzynka narzędziowa Stuff Semi Profi 26

595 (L) x 337 (W) x 316 (H) mm

580 (L) x 315 (W) x 245 (H) mm

COLOR INDEX EAN  

● SKR26SPSTUFFCZAPG001 5901238215202 24 4



Stuff handle
Rączka Stuff
Stuff clasps
Zapięcia Stuff
Deep tray organizer with
sockets and bits storage
Głęboka tacka z otworami
na nasadki i bity
Padlock hole
Miejsce na kłódkę
Side handles
Uchwyty boczne
6 Stuff organizers
6 Organizery Stuff



ToolBox Stuff Semi Profi Alu 16

Skrzynka narzędziowa Stuff Semi Profi Alu 16

415 (L) x 226 (W) x 200 (H) mm

405 (L) x 205 (W) x 145 (H) mm

COLOR INDEX EAN



● SKR16SPALSTUCZAPG001 5901238221548 120 12



Stuff handle
Rączka Stuff
Stuff Alu clasps
Zapięcia Stuff Alu
Deep tray organizer with
sockets and bits storage
Głęboka tacka z otworami
na nasadki i bity
Padlock hole
Miejsce na kłódkę
Side handles
Uchwyty boczne
2 Stuff organizers
2 Organizery Stuff



ToolBox Stuff Semi Profi Alu 20

Skrzynka narzędziowa Stuff Semi Profi Alu 20

525 (L) x 256 (W) x 246 (H) mm

510 (L) x 235 (W) x 190 (H) mm

COLOR INDEX EAN

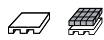

● SKR20SPALSTUCZAPG001 5901238221555 56 7



Stuff handle
Rączka Stuff
Stuff Alu clasps
Zapięcia Stuff Alu
Deep tray organizer with
sockets and bits storage
Głęboka tacka z otworami
na nasadki i bity
Padlock hole
Miejsce na kłódkę
Side handles
Uchwyty boczne
4 Stuff organizers
4 Organizery Stuff



ToolBox Stuff Semi Profi Alu 26

Skrzynka narzędziowa Stuff Semi Profi Alu 26

595 (L) x 337 (W) x 316 (H) mm

580 (L) x 315 (W) x 245 (H) mm

COLOR INDEX EAN



● SKR26SPALSTUCZAPG001 5901238221562 24 4



Stuff handle
Rączka Stuff
Stuff Alu clasps
Zapięcia Stuff Alu
Deep tray organizer with
sockets and bits storage
Głęboka tacka z otworami
na nasadki i bity
Padlock hole
Miejsce na kłódkę
Side handles
Uchwyty boczne
6 Stuff organizers
6 Organizery Stuff







STUFF Module System

Skrzynki Narzędziowe
Stuff Module System

Available colors
Dostępne kolory



STUFF MODULE SYSTEM is an innovative combination of the functionality of the solid tool box with the advantages of a modern system of containers ErgoBox. The modular design of this model ensures the highest ergonomics and the ability to store different tools. All cases in this line are equipped with a deep tray, strong latches and reinforcement - Semi Profi version is enriched with four organizers.

STUFF MODULE SYSTEM to nowatorskie połączenie funkcjonalności solidnej skrzynki narzędziowej z zaletami nowoczesnego systemu pojemników ErgoBox. Modułowa budowa tego modelu gwarantuje najwyższą ergonomię pracy oraz możliwość przechowywania zróżnicowanych narzędzi. Wszystkie skrzynki z tej linii są wyposażone w głębokie tacki, mocne zapięcia oraz wzmocnioną konstrukcję - wersja Semi Profi jest wzbogacona o cztery organizery.

Stuff organizers – allow to storage and ensure easy access to small elements.
Organizery Stuff – pozwalają na magazynowanie i łatwy dostęp do drobnych elementów.



ErgoBox 2 Plus x3

Ergobox Plus is a multi-purpose containers, which in combination with the box STUFF is the perfect modul for storing tools and workshop accessories.

ErgoBox Plus to wielofunkcyjne pojemniki, które w połączeniu ze skrzynką STUFF tworzą idealny modul do przechowywania narzędzi i akcesoriów warsztatowych.



ErgoBox 2 Plus use also with:
ErgoBox 2 Plus używaj również z:

*tools not included/nie zawiera narzędzi

ToolBox Stuff Module System Basic

Skrzynka narzędziowa Stuff Module System Basic

📏 525 (L) x 337 (W) x 316 (H) mm

📏 510 (L) x 235 (W) x 190 (H) mm

COLOR INDEX

EAN



● SKR20BSMSCZAPGO01 5901238223108 42 7



ToolBox Stuff Module System Semi Profi

Skrzynka narzędziowa Stuff Module System Semi Profi

📏 525 (L) x 337 (W) x 316 (H) mm

📏 510 (L) x 235 (W) x 190 (H) mm

COLOR INDEX

EAN



● SKR20SPSMSCZAPG001 5901238223115 42 7



ToolBox Stuff Module System Basic Alu

Skrzynka narzędziowa Stuff Module System Basic Alu

📏 525 (L) x 337 (W) x 316 (H) mm

📏 510 (L) x 235 (W) x 190 (H) mm

COLOR INDEX

EAN



● SKR20BSMSALCZAPG001 5901238224556 42 7



ToolBox Stuff Module System Semi Profi Alu

Skrzynka narzędziowa Stuff Module System Semi Profi Alu

📏 525 (L) x 337 (W) x 316 (H) mm

📏 510 (L) x 235 (W) x 190 (H) mm

COLOR INDEX

EAN



● SKR20SPSMSALCZAPG001 5901238224563 42 7





WheelBox STUFF

Skrzynka narzędziowa
Stuff WheelBox

Available colors
Dostępne kolory



Stuff Wheelbox is a modern, capacious and mobile toolbox. Specially designed cover received additional ribs, which significantly increases its durability. Telescopic handle with ability to adjust its length allows to adapt it to the height of the user. Plastic wheels are additionally protected with rubber layer, which makes them more resistant to mechanical damage as well as prevent the slipping on the ground.

Stuff Wheelbox to nowoczesna, pojemna i mobilna skrzynka narzędziowa. Specjalnie zaprojektowana pokrywa otrzymała dodatkowe ożebrowanie, które znacząco zwiększa jej trwałość. Teleskopowa rączka posiada możliwość regulacji długości, co pozwala dostosować ją do wzrostu użytkownika. Plastikowe koła są dodatkowo zabezpieczone warstwą gumy, co sprawia, że są bardziej odporne na uszkodzenia mechaniczne, jak również zapobiegają ślizganiu się po podłożu.



Don't lift the toolbox with this handle
Nie podnoś skrzynki za rączkę



*tools not included/ nie zawiera narzędzi



Plastic wheels – the rubber layer protects them from mechanical defects.

Plastikowe kółka – zabezpieczone warstwą gumy zapewniają odporność na uszkodzenia mechaniczne.

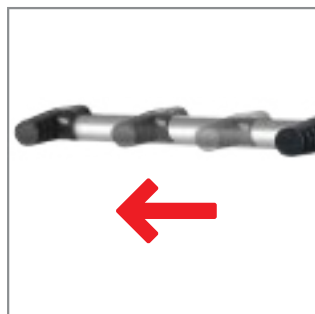

Telescopic handle – allows you to adjust the handle to desired length.

Rączka teleskopowa z możliwością regulacji jego długości.

Wheelbox Stuff Alu Basic 26

Skrzynka narzędziowa na kółkach Stuff Alu Basic 26

↔ 760 (L) x 380 (W) x 330 (H) mm

↕ 580 (L) x 315 (W) x 245 (H) mm

COLOR INDEX

EAN



● SKRW26BALSCZAPG001 5901238221739 18 3



Plastic wheels with rubber layer
Kółka z plastiku zabezpieczone warstwą gumy

Telescopic handle
Teleskopowa rączka

Stuff handle

Rączka Stuff

Alu Stuff clasps

Zapięcia Stuff Alu

Padlock hole

Miejsce na kłódkę

Side handles

Uchwyty boczne



ToolBoxes **ERGO**

Skrzynki narzędziowe Ergo

A family of light, handy boxes. All models are distinctive for their ergonomic design. They are provided with special handles and may be secured with padlocks. The Ergo toolbox family consists of two lines: Ergo Basic, Ergo Expert each come in three different. Additional functionality of this line is the way of packaging the largest toolbox can contain smaller ones inside.

Rodzina lekkich i poręcznych skrzynek. Wszystkie modele charakteryzują się ergonomią wykonania. Zawierają specjalne uchwyty, umożliwiające założenie klódek. W skład rodziny skrzynek Ergo wchodzi dwie linie: Ergo Basic, Ergo Expert, każda w trzech rozmiarach. Dodatkową zaletą jest możliwość pakowania pozwalająca na umieszczenie w największej skrzynce pozostałych dwóch.



CAPTION
LEGENDA

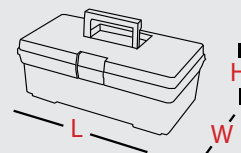

ToolBoxes ERGO

Skrzynki narzędziowe Ergo

Available colors

Dostępne kolory

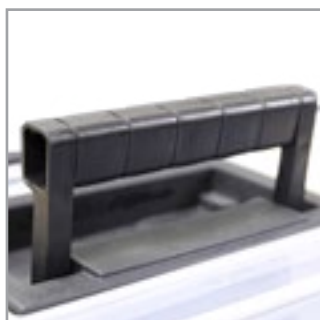

Ergo handle – profiled, practical handle, which thanks to its ergonomic design it fits to your hand perfectly.

Rączka Ergo - wyprofilowana, praktyczna rączka, dzięki ergonomicznemu wykonaniu idealnie pasuje do dłoni.



Ergo latches – thanks to their ergonomic design, allow each box equipped with them to be safely filled to full capacity.

Zapięcia Ergo - dzięki ergonomii wykonania umożliwiają maksymalny udźwig każdej skrzynki, przy której zostały zastosowane.

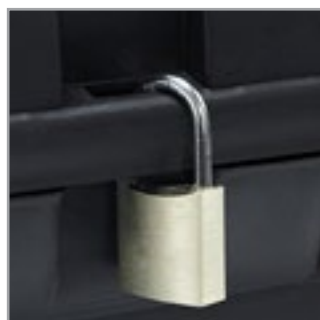

Padlock hole – special hole can be used in the box to protect your tools against theft.

Miejsce na kłódkę - specjalnie wykonany otwór w skrzynce, umożliwia zabezpieczenie magazynowanych narzędzi przed kradzieżą.



Tray – designed to carry tools and small components, enabling you to keep your tools inside the box and maintain in order inside the box.

Tacka - zaprojektowana do przenoszenia narzędzi i małych części, umożliwia przechowywanie sprzętu we wnętrzu skrzynki i utrzymanie w niej porządku.



Expert organizer – transparent organizer located along the entire surface of the cover, makes it easier for you to keep small elements in order, the largest model is additionally supplied with a removable container with partitions and a liner for drill bits.

Organizer Expert - transparentny organizer na całej powierzchni pokrywy, pozwala na łatwe utrzymanie porządku wśród drobnych elementów, największy model został dodatkowo wyposażony w wyjmowany pojemnik z przegrodami oraz wkładkę do wiertel.



Optimal packing.
Optymalne pakowanie.



3 in 1 - storing one toolbox inside another toolbox greatly improves the logistics of packing and storage.



3 w 1 - magazynowanie skrzynek jedna w drugą ułatwia ich pakowanie i poprawia ich logistykę.



ToolBox Ergo Basic 15"

Skrzynka narzędziowa Ergo Basic 15"

383(L) x 188(W) x 168(H) mm

COLOR	INDEX	EAN		
●	SKR15BERGCZAPG001	5902455507880	168	14





Ergo handle
Rączka Ergo
Ergo latches
Zapięcie Ergo
Padlock hole
Miejsce na kłódkę
Tray
Tacka

ToolBox Ergo Basic 19,5"

Skrzynka narzędziowa Ergo Basic 19,5"

480(L) x 260(W) x 225(H) mm

COLOR	INDEX	EAN		
●	SKR19BERGCZAPG001	5902455507064	63	7





Ergo handle
Rączka Ergo
Ergo latches
Zapięcie Ergo
Padlock hole
Miejsce na kłódkę
Tray
Tacka

ToolBox Ergo Basic 27"

Skrzynka narzędziowa Ergo Basic 27"

592(L) x 338(W) x 314(H) mm

COLOR	INDEX	EAN		
●	SKR27BERGCZAPG001	5902455507903	24	4





Ergo handle
Rączka Ergo
Ergo latches
Zapięcie Ergo
Padlock hole
Miejsce na kłódkę
Tray
Tacka

ToolBox Ergo Expert 15"

Skrzynka narzędziowa Ergo Expert 15"

383(L) x 188(W) x 168(H) mm

COLOR	INDEX	EAN		
●	SKR15EERGCZAPG001	5902455507897	168	14





Ergo handle
Rączka Ergo
Ergo latches
Zapięcie Ergo
Padlock hole
Miejsce na kłódkę
Tray
Tacka
Expert organizer with
sockets and bits storage
Organizer Expert z otworami
na nasadki i bity



ToolBox Ergo Expert 19,5"

Skrzynka narzędziowa Ergo Expert 19,5"

480(L) x 260(W) x 225(H) mm

COLOR	INDEX	EAN		
●	SKR19EERGCZAPG001	5902455507699	63	7





Ergo handle
Rączka Ergo
Ergo latches
Zapięcie Ergo
Padlock hole
Miejsce na kłódkę
Tray
Tacka
Expert organizer
Organizer Expert



ToolBox Ergo Expert 27"

Skrzynka narzędziowa Ergo Expert 27"

592(L) x 338(W) x 314(H)mm

COLOR	INDEX	EAN		
●	SKR27EERGCZAPG001	5902455507910	24	4



Ergo handle
Rączka Ergo
Ergo latches
Zapięcie Ergo
Padlock hole
Miejsce na kłódkę
Tray
Tacka
Expert organizer with
sockets and bits storage
Organizer Expert z otworami
na nasadki i bity





CARRIAGES & TOOL CASES

Nosidła i pojemniki na elektronarzędzia

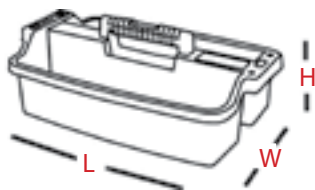



Carriage handle
Rączka
Carriage
Nosidło
Ergonomic packing
Ergonomiczne pakowanie



Carriage Basic

Nosidło Basic

392(L) x 279(W) x 143(H)mm

INDEX	EAN		
NOSMCZAPG001	5901238247371	424	8





Carriage handle
Rączka
Carriage
Nosidło
Ergonomic packing
Ergonomiczne pakowanie

Carriage Premium

Nosidło Premium

520(L) x 320(W) x 195(H)mm

INDEX	EAN		
NOSPREZAPG001	5902455501581	170	5



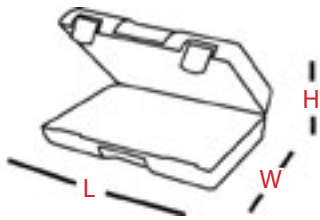



Ergo latches
Zapięcia Ergo
Protective foam
Zabezpieczająca pianka



Tool Case Basic

Pojemnik na elektronarzędzia Basic



400(L) x 320(W) x 120(H)mm

INDEX	EAN		
ELEKTROBCZAPG001	5902455500850	112	7

Tool Case Premium

Pojemnik na elektronarzędzia Premium

400(L) x 320(W) x 180(H)mm

INDEX	EAN		
ELEKTROPREZAPG001	5902455501178	77	7

Ergo latches
Zapięcia Ergo
Protective foam
Zabezpieczająca pianka





Organizers **TANDEM**

Organizery Tandem

Tandem organizers are available in three different versions A, B and C. The first has fixed partitions for small items. The second's feature are adjustable ones. Version C has a set of containers CombiBox. The entire line is characterized by durability, functionality, aesthetic finish and modern design. The two organizers of each size can be combined so that they gain additional functionality both during storage and handling.

Organizery Tandem dostępne są w trzech różnych wersjach A, B oraz C. Pierwsza posiada stałe przegrody na drobne elementy. Drugą charakteryzują wyjmowane przegrody. Wersja C posiada zestaw pojemników CombiBox. Całą linię cechuje wytrzymałość, funkcjonalność, estetyczne wykończenie oraz nowoczesny design. Dwa organizery z każdego rozmiaru można łączyć, dzięki czemu zyskują one dodatkową funkcjonalność zarówno podczas przechowywania jak i przenoszenia.

Tandem A



Compartments – thank to which, all small accessories kept in the organizer will always be in their right place.

Przegrody - dzięki nim wszystkie drobne akcesoria przechowywane w organizerze będą zawsze na właściwym miejscu.

CAPION
LEGENDA

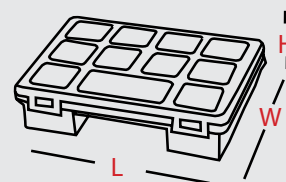

Tandem B



Adjustable compartments allow you to adjust their size to the size of the stored accessories. With this functionality you can effortlessly adjust the organizer to individual needs.

Regulowane przegrody pozwalają na dopasowanie ich wielkości do rozmiarów przechowywanych akcesoriów. Dzięki tej funkcjonalności można bez wysiłku dostosować organizer do indywidualnych potrzeb.

Adjustable dividers
Regulowane przegrody



Tandem C

Transparent cover – helps to find quickly necessary elements.

Transparentna pokrywa - umożliwia szybkie odszukanie potrzebnych elementów.



Combi Boxes – they facilitate the storage of small elements. Available in 4 sizes, giving you a possibility to match their size with your individual needs.

CombiBoxes - znacznie ułatwiają magazynowanie drobnych elementów. Występujące w 4 rozmiarach, dają możliwość dopasowania ich wielkości do indywidualnych potrzeb.

Tandem Twin

Hinges – they allow you to join organizers together and carry larger number of items at once.

Zawiasy - umożliwiają łączenie organizerów i przenoszenie jednorazowo większej ilości elementów.

Tandem Twin - combining two organizers with covers inside helps to protect lid from scratches. Tandem Twin is a great solution when significant numbers of accessories or small tools need to be moved.

Tandem Twin - połączenie organizerów pokrywami do siebie zmniejsza prawdopodobieństwo rysowania się przeźroczy. Tandem Twin stanowi także znaczne ułatwienie przy transporcie sporej ilości drobnych elementów.





*tools not included/nie zawiera narzędzi

Organizer Tandem A 200

Organizer Tandem A 200

192(L) x 143(W) x 50(H)mm

INDEX	EAN		
ORGA200TCCZAPG001	5901238215813	1344	28





Transparent cover
Transparentna pokrywa
Compartments: 6
Komory: 6



Organizer Tandem A 300

Organizer Tandem A 300

284(L) x 192(W) x 50(H)mm

INDEX	EAN		
ORGA300TCCZAPG001	5901238243595	576	24





Transparent cover
Transparentna pokrywa
Compartments: 1
Komory: 1



Organizer Tandem A 400

Organizer Tandem A 400

385(L) x 283(W) x 50(H)mm

INDEX	EAN		
ORGA400TCCZAPG001	5901238209584	288	12



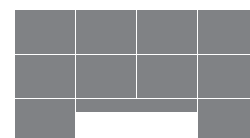

Transparent cover
Transparentna pokrywa
Compartments: 7
Komory: 7



Organizer Tandem B 200

Organizer Tandem B 200

192(L) x 143(W) x 50(H)mm

INDEX	EAN		
ORGB200TCZAPG001	5901238209591	1344	28



Transparent cover
Transparentna pokrywa
Adjustable dividers: 5
Regulowane przegrody: 5
Maximum compartments: 11
Maksymalna ilość komór: 11





*Adjustable dividers inserted loosely inside
Ruchome przegrody włożone luźno do organizera

Organizer Tandem B 300

Organizer Tandem B 300

284(L) x 192(W) x 50(H)mm

INDEX	EAN		
ORGB300TCZAPG001	5901238209607	576	24



Transparent cover
Transparentna pokrywa
Adjustable dividers: 10
Regulowane przegrody: 10
Maximum compartments: 14
Maksymalna ilość komór: 14





*Adjustable dividers inserted loosely inside
Ruchome przegrody włożone luźno do organizera

Organizer Tandem B 400

Organizer Tandem B 400

385(L) x 283(W) x 50(H)mm

INDEX	EAN		
ORGB400TCZAPG001	5901238209614	288	12



Transparent cover
Transparentna pokrywa
Adjustable dividers: 21
Regulowane przegrody: 21
Maximum compartments: 27
Maksymalna ilość komór: 27





*Adjustable dividers inserted loosely inside
Ruchome przegrody włożone luźno do organizera

Organizer Tandem C 200

Organizer Tandem C 200

192(L) x 143(W) x 50(H)mm

INDEX	EAN		
ORGC200TCZAPG001	5901238209621	1344	28





Transparent cover
Transparentna pokrywa
CombiBoxes
CombiBoxes



Organizer Tandem C 300

Organizer Tandem C 300

284(L) x 192(W) x 50(H)mm

INDEX	EAN		
ORGC300TCZAPG001	5901238209638	576	24





Transparent cover
Transparentna pokrywa
CombiBoxes
CombiBoxes



Organizer Tandem C 400

Organizer Tandem C 400

385(L) x 283(W) x 50(H)mm

INDEX	EAN		
ORGC400TCZAPG001	5901238209645	288	12





Transparent cover
Transparentna pokrywa
CombiBoxes
CombiBoxes



Organizer Tandem 200 Twin

Organizer Tandem 200 Twin

192(L) x 143(W) x 100(H)mm

	INDEX	EAN		
A	ORGA200TX2CZAPG001	5901238209935	576	12
B	ORGB200TX2CZAPG001	5901238209966	576	12
C	ORGC200TX2CZAPG001	5901238209997	576	12





Transparent cover (A, B, C)
 Transparentna pokrywa (A, B, C)
 Dividers (B)
 Przegrody (B)
 CombiBoxes (C)
 CombiBoxes (C)
 Compartments (A)
 Komory (A)
 Hinges (A, B, C)
 Zawiasy (A, B, C)



Organizer Tandem 300 Twin

Organizer Tandem 300 Twin

284(L) x 192(W) x 100(H)mm

	INDEX	EAN		
A	ORGA300TCX2CZAPG001	5901238244226	288	12
B	ORGB300TX2CZAPG001	5901238209973	288	12
C	ORGC300TX2CZAPG001	5901238210009	288	12





Transparent cover (A, B, C)
 Transparentna pokrywa (A, B, C)
 Dividers (B)
 Przegrody (B)
 CombiBoxes (C)
 CombiBoxes (C)
 Compartments (A)
 Komory (A)
 Hinges (A, B, C)
 Zawiasy (A, B, C)



Organizer Tandem 400 Twin

Organizer Tandem 400 Twin

385(L) x 283(W) x 100(H)mm

	INDEX	EAN		
A	ORGA400TCX2CZAPG001	5901238244233	144	6
B	ORGB400TX2CZAPG001	5901238209980	144	6
C	ORGC400TX2CZAPG001	5901238210016	144	6



Transparent cover (A, B, C)
 Transparentna pokrywa (A, B, C)
 Dividers (B)
 Przegrody (B)
 CombiBoxes (C)
 CombiBoxes (C)
 Compartments (A)
 Komory (A)
 Hinges (A, B, C)
 Zawiasy (A, B, C)





CombiBoxes

CombiBoxes

CombiBoxes greatly facilitate the storage of small elements. They are available in 4 sizes and can be used as an individual product, or supplement to virtually any box, container or organizer.

CombiBoxes znacznie ułatwiają magazynowanie drobnych elementów. Występujące w 4 rozmiarach, mogą stanowić samodzielny produkt lub być uzupełnieniem praktycznie każdej skrzynki, pojemnika, czy organizera.



Supplement to organizer inside
the ToolBox Formula RS
Uzupełnienie organizera w
skrzynce Formula RS



Single product
packaged in display
Samodzielny produkt
pakowany w display





Supplement to organizer inside
the Tandem C
Uzupełnienie organizera w
Tandemie C

CombiBox 1 x5

CombiBox 1

41(L) x 41(W) x 45(H) mm

SET: 41(L) x 41(W) x 110(H) mm

INDEX	EAN		 / 
Z213604PG001	5901238213604	8640	96

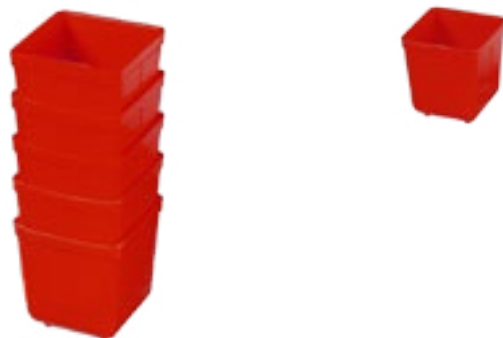



CombiBox 2 x5

CombiBox 2

41(L) x 84(W) x 45(H) mm

SET: 41(L) x 84(W) x 110(H) mm

INDEX	EAN		 / 
Z213611PG001	5901238213611	4320	48

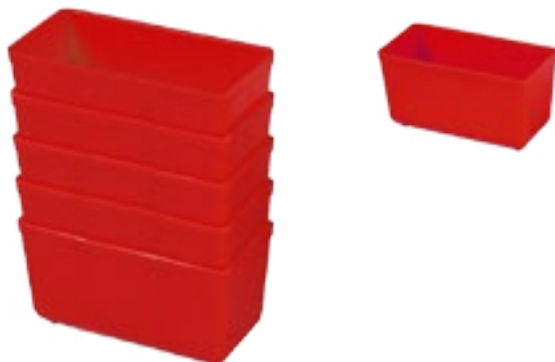



CombiBox 3 x5

CombiBox 3

84(L) x 84(W) x 45(H) mm

SET: 84(L) x 84(W) x 105(H) mm

INDEX	EAN		 / 
Z213628PG001	5901238213628	2160	24





CombiBox 4 x3

CombiBox 4

124(L) x 84(W) x 45(H) mm

SET: 124(L) x 84(W) x 80(H) mm

INDEX	EAN		 / 
Z213635PG001	5901238213635	2160	24





Organizers **DOMINO**

Organizery Domino

The organizers are perfect for both professional work and hobby. They help you to arrange all components, and thanks to their transparent covers, you can easily determine what is inside. Organizer 36 is additionally equipped with a handle and a system of removable partitions. Whole line characterizes weight, convenience and aesthetic design.

Organizery idealnie nadają się do pracy zawodowej, jak i do zajęć hobbystycznych. Pozwalają na posegregowanie wszystkich detali, a dzięki przezroczystej pokrywie łatwo określić, co się w nich znajduje. Organizer 36 został dodatkowo wyposażony w rączkę i system wyjmowanych przegród. Całą serię cechuje lekkość, poręczność i estetyczne wykonanie.

CAPTION
LEGENDA

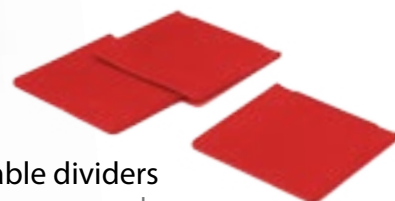
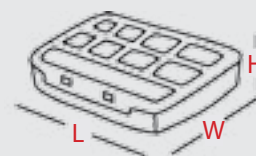

Adjustable dividers Regulowane przegrody

*Adjustable dividers inserted loosely inside
Ruchome przegrody włożone luźno do organizera

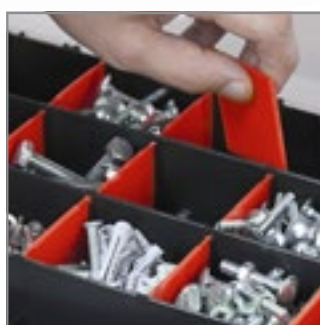

Adjustable dividers – allow you to adjust the product to your individual needs.

Regulowane przegrody - pozwalają przystosować produkt do indywidualnych potrzeb.

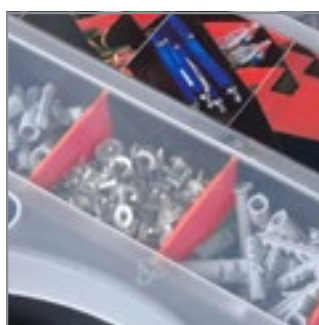

Transparent cover – helps to find necessary elements in a really short time.

Transparentna pokrywa- umożliwia szybkie odszukanie potrzebnych elementów.



Compartments – thanks to which, all small accessories kept in the organizer will always be in their right place.

Komory - dzięki nim wszystkie drobne akcesoria przechowywane w organizerze będą zawsze na właściwym miejscu.



Clasps 36 – they protect small elements kept in the organizer from falling out.

Zapięcia 36 - zabezpieczają przed wypadaniem znajdujących się w organizerze elementów.





*tools not included/nie zawiera narzędzi

Organizer Domino 12

Organizer Domino 12

120(L) x 100(W) x 30(H)mm

INDEX	EAN		
ORG12DOMCZAPG001	5902455507033	3648	38



Domino display
Ekspozytor Domino

Transparent cover
Transparentna pokrywa



Compartments: 8
Komory: 8



Organizer Domino 19

Organizer Domino 19

190(L) x 155(W) x 37(H)mm

INDEX	EAN		
ORG19DOMCZAPG001	5902455507040	1536	32



Domino display
Ekspozytor Domino

Transparent cover
Transparentna pokrywa

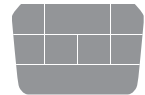

Compartments: 8
Komory: 8



Organizer Domino 25

Organizer Domino 25

250(L) x 200(W) x 44(H)mm

INDEX	EAN		
ORG25DOMCZAPG001	5902455507057	768	16



Domino display
Ekspozytor Domino

Transparent cover
Transparentna pokrywa

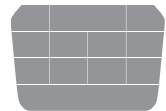

Compartments: 12
Komory: 12



Organizer Domino 32

Organizer Domino 32

325(L) x 260(W) x 65(H)mm

INDEX	EAN		
ORG32DOMCZAPG001	5901238244202	300	10

*Adjustable dividers inserted loosely inside
Ruchome przegrody włożone luźno do organizera



Transparent cover
Transparentna pokrywa

Clasps
Zapięcia

Adjustable dividers: 15
Regulowane przegrody: 15

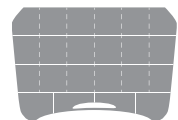

Maximum compartments: 22
Maksymalna ilość komór: 22



Organizer Domino 36

Organizer Domino 36

364(L) x 268(W) x 66(H)mm

INDEX	EAN		
ORG36DOMCZAPG001	5902455508443	270	10



Transparent cover
Transparentna pokrywa

Clasps
Zapięcia

Adjustable dividers: 15
Regulowane przegrody: 15

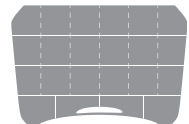

Maximum compartments: 22
Maksymalna ilość komór: 22



Organizer Domino 45

Organizer Domino 45

450(L) x 340(W) x 68(H)mm

INDEX	EAN		
ORG45DOMCZAPG001	5901238244219	150	5



Transparent cover
Transparentna pokrywa

Clasps
Zapięcia

Adjustable dividers: 20
Regulowane przegrody: 20

Maximum compartments: 28
Maksymalna ilość komór: 28

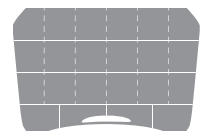



Organizers **CLASSIC**

Organizery Classic

Thanks to the organizers, all small accessories will always be within reach and in their right place. Most models are equipped with a handle, and in the case of the XL organizer you can adjust the number and the size of its compartments, allowing you to adapt the product with your individual needs.

Dzięki nim wszystkie drobne akcesoria będą zawsze pod ręką i na właściwym miejscu. Większość modeli wyposażonych jest w rączkę, a w organizerze XL ilość i wielkość komór jest regulowana, co pozwala przystosować produkt do indywidualnych potrzeb.

CAPTION
LEGENDA

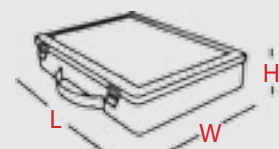

Handle – comfortable handle enhancing the comfort of use.

Rączka - szeroka, wygodna rączka zwiększa komfort użytkownika.



Adjustable compartments – allow you to adjust the product to your individual needs.

Regulowane przegrody - pozwalają przystosować produkt do indywidualnych potrzeb.



Compartments – thanks to which, all small accessories kept in the organizer will always be in their right place.

Komory - dzięki nim wszystkie drobne akcesoria przechowywane w organizerze będą zawsze na właściwym miejscu.

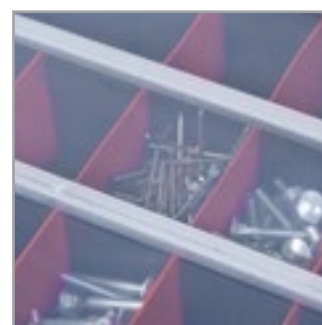

Transparent cover – helps to quickly find necessary elements in a really short time.

Transparentna pokrywa - umożliwia szybkie odszukanie potrzebnych elementów.

*tools not included/nie zawiera narzędzi

Transparent cover
 Transparentna pokrywa
 Compartments: 7
 Komory: 7



Organizer Classic 200

Organizer Classic 200
 200(L) x 145(W) x 35(H)mm

INDEX	EAN		
ORG200CZAPG001	5902455501567	1760	10



Transparent cover
 Transparentna pokrywa
 Handle
 Rączka
 Compartments: 10
 Komory: 10



Organizer Classic 300

Organizer Classic 300
 300(L) x 220(W) x 55(H)mm

INDEX	EAN		
ORG300CZAPG001	5902455501574	420	10



Handle
 Transparent cover
 Transparentna pokrywa
 Rączka
 Compartments: 11
 Komory: 11



Organizer Classic 350

Organizer Classic 350
 345(L) x 245(W) x 60(H)mm

INDEX	EAN		
ORG350CZAPG001	5902455501840	270	10



Transparent cover
 Transparentna pokrywa
 Comfortable XL handle
 Wygodna rączka XL
 Adjustable dividers: 21
 Regulowane przegrody: 21
 Maximum compartments: 26
 Maksymalna ilość komór: 26



Organizer Classic XL

Organizer Classic XL
 460(L) x 325(W) x 80(H)mm

INDEX	EAN		
ORGXLCZAPG001	5902455500003	125	5



*Adjustable dividers inserted loosely inside
 Ruchome przegrody włożone luźno do organizera



WORKSHOP STORAGE

Organizacja warsztatu

The entire family of our products allows you to save storage space. A special system of "clasps" makes it possible to build modulboxes and create walls of several meters. The product is ideal for stores and workshops. The containers are durable and easy to use. Ergoboxes are constructed in way to make it possible to put one inside another, which exceptionally improves the logistics. On the other hand, the CombiBoxes facilitate the storage of small elements. They are available in 4 sizes and can be used as individual product, or as a supplement to virtually any box, container or organizer.

Oszczędność miejsca i stabilność to największe atuty tej rodziny produktów. Specjalny system „zatrząsków” pozwala na budowanie z modułboxów nawet kilkunastometrowych ścian. Produkt nadaje się idealnie do sklepów i warsztatów. Pojemniki te są wytrzymałe i łatwe w użytkowaniu. Ergoboxy zostały skonstruowane z opcją wkładania jeden w drugi, co niezwykle ułatwia ich pakowanie i poprawia ich logistykę. Z kolei CombiBoxy znacznie upraszczają magazynowanie drobnych elementów. Występujące w 4 rozmiarach mogą stanowić samodzielny produkt, lub być uzupełnieniem praktycznie każdej skrzynki, pojemnika czy organizera.

CAPTION
LEGENDA

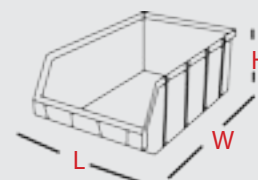

Ergonomic packing – storing one container inside another container exceptionally improves the logistics of packing.

Ergonomiczne pakowanie - magazynowanie pojemników jeden w drugi niezwykle ułatwia ich pakowanie i poprawia ich logistykę.



Slat attachments – you can attach it with screws along with containers to a wall, improving the way you use the space.

Listwa - można ją przykręcić wraz z pojemnikami do ściany umożliwiając tym samym lepsze wykorzystanie przestrzeni.



Possibility of stacking – arranging the products one on top of another significantly economizes space, which is a great advantage in case of small workshops.

Możliwość piętrowania - umożliwia znaczną oszczędność miejsca, co staje się udogodnieniem w niewielkich warsztatach.



Modules – special clasps make it possible to create even several meters walls of moduloboxes.

Moduły - specjalne zatrzaski pozwalają budować moduły nawet kilkumetrowych ścian.



Fixing wall – it is a useful addition to the containers. Those racks can hold several containers of different sizes, which is very useful in small workshops.

Płyta warsztatowa - stanowi niezmiernie użyteczny dodatek do pojemników. Przywiercona do ściany może pomieścić nawet kilka pojemników w różnych rozmiarach, co jest niezwykle przydatne w niewielkich warsztatach.



Space for label – a place designed for a label allows you to write down what elements are kept in the box; in this way, you will be able to identify them more readily.

Miejsce na etykietę - specjalne miejsce na naklejkę pozwala podpisać, jakie elementy są w pojemniku przechowywane, a to ułatwia ich szybkie zidentyfikowanie.

ErgoBox Plus use also with:
ErgoBox Plus używaj również z:



Stuff Module System



Metal & Plastic Slat



Fixing Wall 350



Ergobox Plus

Ergobox Plus containers, which separately or in combination with other products form a perfect module for storing tools and workshop accessories.



ErgoBox Plus to pojemniki, które samodzielnie lub w połączeniu z innymi produktami tworzą idealny moduł do przechowywania narzędzi i akcesoriów warsztatowych.

*tools not included/nie zawiera narzędzi

Ecobox mini

Ecobox mini

110(L) x 90(W) x 50(H) mm

COLOR	INDEX	EAN		
●	ECOMINCZAPG001	5902455502779	3936	41
●	ECOMINZIEPG001	5902455502816	3936	41
●	ECOMINNIIEPG001	5902455502786	3936	41
●	ECOMINCZEPG001	5902455502793	3936	41
●	ECOMINZOLPG001	5902455502809	3936	41



Possibility of stacking
Możliwość piętrzenia
Space for label
Miejsce na etykietę

***Optional:**
***Opcjonalnie:**
Metal or plastic slat
Listwa metalowa lub plastikowa





Fixing wall
Płyta warsztatowa



Ecobox small

Ecobox mały

110(L) x 165(W) x 75(H) mm

COLOR	INDEX	EAN		
●	ECOMALCZAPG001	5902455501154	1680	35
●	ECOMALZIEPG001	5902455501338	1680	35
●	ECOMALNIEPG001	5902455501321	1680	35
●	ECOMALCZEPG001	5902455501314	1680	35
●	ECOMALZOLPG001	5902455501147	1680	35



Possibility of stacking
Możliwość piętrzenia
Space for label
Miejsce na etykietę

***Optional:**
***Opcjonalnie:**
Metal or plastic slat
Listwa metalowa lub plastikowa





Fixing wall
Płyta warsztatowa



Ecobox medium

Ecobox średni

155(L) x 240(W) x 125(H) mm

COLOR	INDEX	EAN		
●	ECOSREZAPG001	5902455501383	490	35
●	ECOSREZIEPG001	5902455501369	490	35
●	ECOSRENIIEPG001	5902455501352	490	35
●	ECOSREZEPG001	5902455501161	490	35
●	ECOSREZOLPG001	5902455501376	490	35



Possibility of stacking
Możliwość piętrzenia
Space for label
Miejsce na etykietę

***Optional:**
***Opcjonalnie:**
Metal or plastic slat
Listwa metalowa lub plastikowa





Fixing wall
Płyta warsztatowa



Ecobox large

Ecobox duży

220(L) x 350(W) x 165(H)mm

COLOR	INDEX	EAN		
●	ECODUZCZAPG001	5902455501437	140	10
●	ECODUZZIEPG001	5902455501413	140	10
●	ECODUZNIIEPG001	5902455501406	140	10
●	ECODUZCZEPG001	5902455501390	140	10
●	ECODUZZOLPG001	5902455501420	140	10



Possibility of stacking
Możliwość piętrzenia
Space for label
Miejsce na etykietę

***Optional:**
***Opcjonalnie:**
Metal or plastic slat
Listwa metalowa lub plastikowa



Fixing wall
Płyta warsztatowa





Ergobox 1

Ergobox 1

116(L) x 112(W) x 75(H)mm

COLOR	INDEX	EAN		
●	ERG1CZAPG001	5907763088892	4800	48
●	ERG1CZEPG001	5907763088915	4800	48
●	ERG1NIEPG001	5907763088908	4800	48
●	ERG1ZIEPG001	5901238214380	4800	48
●	ERG1ZOLPG001	5901238212980	4800	48
●	ERG1POMPG001	5901238238881	4800	48



Ergobox 1 Plus

Ergobox 1 Plus

116(L) x 112(W) x 75(H)mm

COLOR	INDEX	EAN		
●	ERG1PCZAPG001	5901238242772	2400	24
●	ERG1PCZEPG001	5901238242789	2400	24
●	ERG1PNIEPG001	5901238242796	2400	24
●	ERG1PZIEPG001	5901238242802	2400	24
●	ERG1PZOLPG001	5901238242819	2400	24
●	ERG1PPOMPG001	5901238242826	2400	24

Ergonomic packing
Ergonomiczne pakowanie
Possibility of stacking
Możliwość piętrowania
Space for label
Miejsce na etykietę

***Optional:**

***Opcjonalnie:**

Metal or plastic slat

Listwa metalowa lub plastikowa



Fixing wall

Płyta warsztatowa



Ergobox 2

Ergobox 2

116(L) x 161(W) x 75(H)mm

COLOR	INDEX	EAN		
●	ERG2CZAPG001	5907763088922	3600	36
●	ERG2CZEPG001	5907763088946	3600	36
●	ERG2NIEPG001	5907763088939	3600	36
●	ERG2ZIEPG001	5901238214571	3600	36
●	ERG2ZOLPG001	5902455508658	3600	36
●	ERG2POMPG001	5901238238898	3600	36



Ergobox 2 Plus

Ergobox 2 Plus

116(L) x 161(W) x 75(H)mm

COLOR	INDEX	EAN		
●	ERG2PCZAPG001	5901238224600	1800	18
●	ERG2PCZEPG001	5901238224570	1800	18
●	ERG2PNIEPG001	5901238224617	1800	18
●	ERG2PZIEPG001	5901238236221	1800	18
●	ERG2PZOLPG001	5901238236238	1800	18
●	ERG2PPOMPG001	5901238238904	1800	18

Ergonomic packing
Ergonomiczne pakowanie
Possibility of stacking
Możliwość piętrowania
Space for label
Miejsce na etykietę

***Optional:**

***Opcjonalnie:**

Metal or plastic slat

Listwa metalowa lub plastikowa



Fixing wall

Płyta warsztatowa



Ergobox 2L

Ergobox 2L

116(L) x 212(W) x 75(H)mm

COLOR	INDEX	EAN		
●	ERG2LCZAPG001	5907763089042	2400	24
●	ERG2LCZEPG001	5907763089066	2400	24
●	ERG2LNIEPG001	5907763089059	2400	24
●	ERG2LZIEPG001	5901238214465	2400	24
●	ERG2LZOLPG001	5901238214472	2400	24
●	ERG2LPOMPG001	5901238238942	2400	24



Ergobox 2L Plus

Ergobox 2L Plus

116(L) x 212(W) x 75(H)mm

COLOR	INDEX	EAN		
●	ERG2LPCZAPG001	5901238242833	1056	22
●	ERG2LPCZEPG001	5901238242840	1056	22
●	ERG2LPNIEPG001	5901238242857	1056	22
●	ERG2LPZIEPG001	5901238242864	1056	22
●	ERG2LPZOLPG001	5901238242871	1056	22
●	ERG2LPPOMPG001	5901238242888	1056	22

Ergonomic packing
Ergonomiczne pakowanie
Possibility of stacking
Możliwość piętrowania
Space for label
Miejsce na etykietę

***Optional:**

***Opcjonalnie:**

Metal or plastic slat

Listwa metalowa lub plastikowa



Fixing wall

Płyta warsztatowa







Ergobox 3

Ergobox 3

170(L) x 240(W) x 126(H)mm



COLOR	INDEX	EAN		
●	ERG3CZAPG001	5907763088953	1000	10
●	ERG3CZEPG001	5907763088977	1000	10
●	ERG3NIEPG001	5907763088960	1000	10
●	ERG3ZIEPG001	5901238214403	1000	10
●	ERG3ZOLPG001	5901238214410	1000	10
●	ERG3POMPG001	5901238238911	1000	10



Ergobox 3 Plus

Ergobox 3 Plus

170(L) x 240(W) x 126(H)mm

COLOR	INDEX	EAN		
●	ERG3PCZAPG001	5901238242895	528	22
●	ERG3PCZEPG001	5901238242901	528	22
●	ERG3PNIEPG001	5901238242918	528	22
●	ERG3PZIEPG001	5901238242925	528	22
●	ERG3PZOLPG001	5901238242932	528	22
●	ERG3PPOMPG001	5901238242949	528	22

Ergonomic packing
Ergonomiczne pakowanie
Possibility of stacking
Możliwość piętrowania
Space for label
Miejsce na etykietę

***Optional:**
***Opcjonalnie:**

Metal or plastic slat
Listwa metalowa lub plastikowa





Fixing wall
Płyta warsztatowa



Ergobox 4

Ergobox 4

204(L) x 340(W) x 155(H)mm

COLOR	INDEX	EAN		
●	ERG4CZAPG001	5907763088984	1144	13
●	ERG4CZEPG001	5907763089004	1144	13
●	ERG4NIEPG001	5907763088991	1144	13
●	ERG4ZIEPG001	5901238214427	1144	13
●	ERG4ZOLPG001	5901238214434	1144	13
●	ERG4POMPG001	5901238238928	1144	13





Ergonomic packing
Ergonomiczne pakowanie
Possibility of stacking
Możliwość piętrowania
Space for label
Miejsce na etykietę

Ergobox 5

Ergobox 5

333(L) x 500(W) x 187(H)mm

COLOR	INDEX	EAN		
●	ERG5CZAPG001	5907763089011	300	5
●	ERG5CZEPG001	5907763089035	300	5
●	ERG5NIEPG001	5907763089028	300	5
●	ERG5ZIEPG001	5901238214441	300	5
●	ERG5ZOLPG001	5901238214458	300	5
●	ERG5POMPG001	5901238238935	300	5





Ergonomic packing
Ergonomiczne pakowanie
Possibility of stacking
Możliwość piętrowania
Space for label
Miejsce na etykietę

Modulbox 1.1

Modułbox 1.1

110(L) x 165(W) x 75(H) mm

COLOR	INDEX	EAN		
●	MOD11CZAPG001	5902455502533	1400	35



***Optional:**
***Opcjonalnie:**
Metal or plastic slat
Listwa metalowa lub plastikowa



Fixing wall
Płyta warsztatowa



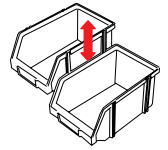

Possibility of stacking
Możliwość piętrowania
Space for label
Miejsce na etykietę
Modules
Moduły



Modulbox 2.1

Modułbox 2.1

150(L) x 230(W) x 125(H) mm

COLOR	INDEX	EAN		
●	MOD21CZAPG001	5902455502540	490	35



***Optional:**
***Opcjonalnie:**
Metal or plastic slat
Listwa metalowa lub plastikowa



Fixing wall
Płyta warsztatowa



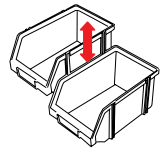

Possibility of stacking
Możliwość piętrowania
Space for label
Miejsce na etykietę
Modules
Moduły



Modulbox 3.1

Modułbox 3.1

210(L) x 350(W) x 160(H) mm

COLOR	INDEX	EAN		
●	MOD31CZAPG001	5902455502557	192	12



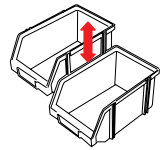

Possibility of stacking
Możliwość piętrowania
Space for label
Miejsce na etykietę
Modules
Moduły



Modulbox 4.1

Modułbox 4.1

310(L) x 490(W) x 190(H) mm

COLOR	INDEX	EAN		
●	MOD41CZAPG001	5902455502564	88	6



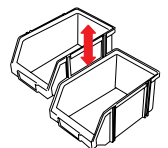

Possibility of stacking
Możliwość piętrowania
Space for label
Miejsce na etykietę
Modules
Moduły



Modulbox 4.1D

Modułbox 4.1D

310(L) x 490(W) x 190(H) mm

COLOR	INDEX	EAN		
●	MOD41DCZAPG001	5902455502595	88	6



Compartment
Stała przegroda



Possibility of stacking
Możliwość piętrowania
Space for label
Miejsce na etykietę
Modules
Moduły

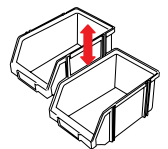

Fixing WALL

Zestaw płyty warsztatowej Fixing Wall

Board Workshop is a modern system for a professional workshop in even small spaces. Attached to the wall plate allows installation Ergobox containers in various sizes and combinations. In turn, a set of dedicated holders is a perfect solution for storing different tools.

Płyta Warsztatowa to nowoczesny system pozwalający na stworzenie profesjonalnego warsztatu w nawet niewielkich pomieszczeniach. Przytwierdzona do ściany płyta umożliwia montaż pojemników ErgoBox w różnych rozmiarach i kombinacjach. Z kolei zestaw dedykowanych uchwytów to idealne rozwiązanie do przechowywania zróżnicowanych narzędzi.





*tools not included/nie zawiera narzędzi

Fixing Wall 350 Set 1.1

Zestaw płyty warsztatowej 350 1.1

345 (L) x 385 (W) x 90 (H)mm

INDEX	EAN		
Z212379PG001	5901238212379	104	26

Fixing Wall 350 x1

Płyta warsztatowa 350 x1

Storage containers:

Pojemniki magazynowe:

Ergobox 1 czerwony/red x 3

Ergobox 1 czarny/black x 3



Ergobox 1 niebieski/blue x 3



Fixing Wall Starter

Zestaw płyty warsztatowej Fixing Wall Starter

400 (A) x 360 (B) x 130 (C)mm

INDEX	EAN		
Z221241PG001	5901238221241	90	6

Fixing Wall 350 black x2

Płyta 350 czarna x2

Fixing Wall accessories: A11 red x1

Akcesoria płyty warsztatowej: A 11 czerwone x1

Storage containers:

Pojemniki magazynowe:

Ergobox 1 czerwony/red x 3

Ergobox 2 czerwony/red x 3



Ergobox 2.L czerwony/red x 3



Fixing Wall Medium

Zestaw płyty warsztatowej Fixing Wall Medium

600 (A) x 360 (B) x 155 (C)mm

INDEX	EAN		
Z218265PG001	5901238218265	52	4

Fixing Wall 350 black x2

Płyta 350 czarna x2

Tool rack x1

Półka narzędziowa

Fixing Wall accessories: A11 red x1

Akcesoria płyty warsztatowej: A 11 czerwone x1

Fixing Wall accessories: B12 red x1 (no hangers)

Akcesoria płyty warsztatowej: B12 czerwone x1 (bez wieszaków)

Storage containers:

Pojemniki magazynowe:

Ergobox 1 czerwony/red x 3

Ergobox 2 czerwony/red x 3

Ergobox 2.L czerwony/red x 3



PEGBOARD KIT

Perforacja





Pegboard kit – individual tools will find their place, which guarantees that order is kept in every workshop.

Perforacja - pojedyncze narzędzia znajdą swoje stałe miejsce, co gwarantuje utrzymanie porządku w każdym warsztacie.

Pegboard kit red

Perforacja

800(L) x 250(W) x 500(H)mm

INDEX	EAN		
PERFORCZEPG001	5902455501505	126	9

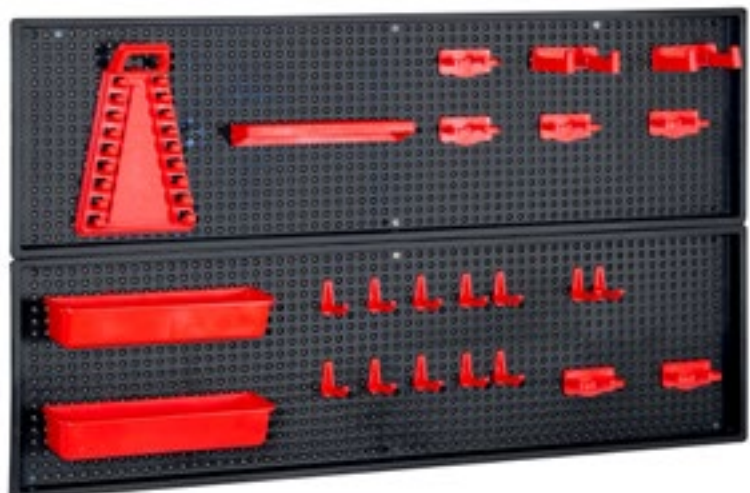

*tools not included/nie zawiera narzędzi

Workshop ACCESSORIES

Akcesoria Warsztatowe



Tool rack – attached to a wall with screws, enables you to use the space in a better way, and thanks to its design, all tools are easily accessible.

Półka narzędziowa - przykręcona do ściany umożliwia lepsze wykorzystanie przestrzeni, a dzięki znajdującym się w niej otworom uzyskuje się łatwy dostęp do wszystkich narzędzi.

Mitre box – a handy appliance which allows to cut materials quickly and evenly.

Skrzynka uciosowa - poręczny przyrząd ułatwiający szybkie i równe cięcie materiałów.



Modules – a special construction of the drawers enables their disassembly into basic modules and reassembly into any shape.

Moduły - specjalna konstrukcja szufladek pozwala na rozkładanie ich na podstawowe moduły i ponowne składanie w dowolny gabaryt.

Metal fixing wall 600

Metalowa płyta warsztatowa 600

575(L) x 3(W) x 381,5(H)mm

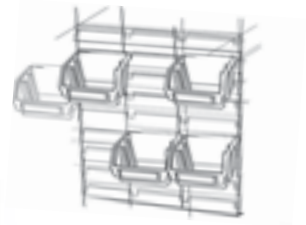
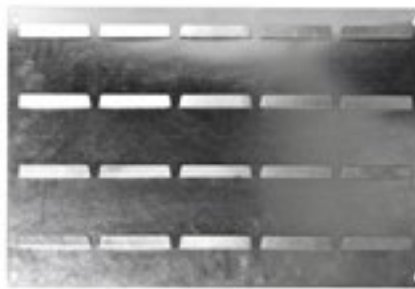

COLOR	INDEX	EAN		
●	PLYTAWARMETPG001	5901238242956	384	8



Metal fixing wall 350

Metalowa płyta warsztatowa 350

362(L) x 3(W) x 382(H)mm

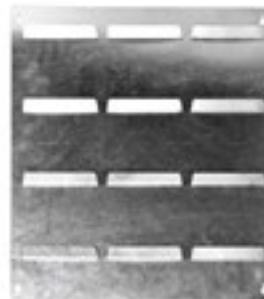

COLOR	INDEX	EAN		
●	PLYTAWARMET350PG001	5901238245643	864	8



Fixing wall 350

Płyta warsztatowa 350

350(L) x 18(W) x 386(H)mm

COLOR	INDEX	EAN		
●	PERFORERGPPIOPG001	5901238209928	600	20
●	PERFORERGPPIOCZAPG001	5901238214298	600	20



Fixing wall 350 accessories A 11

Akcesoria płyty warsztatowej 350 A11

Keys holders x1



Uchwyt na klucze x1

Short hangers x5

Haczyki krótkie x5

Long hangers x5

Haczyki długie x5

COLOR	INDEX	EAN		
●	APW350A11CZEPG001	5901238215776	1728	18

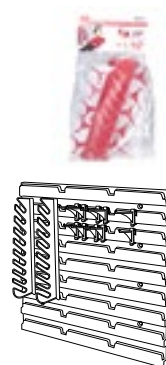
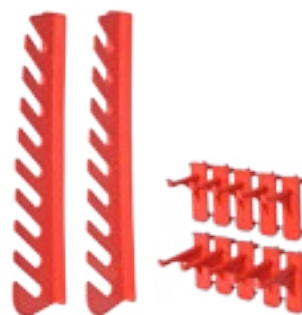

Fixing wall 350 accessories B 12

Akcesoria płyty warsztatowej 350 B12

Shelf for drilling bits and sockets x 1



Półka na wiertła i bity x1

Shelf for minor tools x 1

Półka na drobne narzędzia x 1

Holders x 10

Uchwyty x 10

COLOR	INDEX	EAN		
●	APW350B12CZEPG001	5901238215042	1536	16



Plastic Slat

Listwa plastikowa

495(L) x 40(W) mm

INDEX

EAN

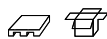

LISTWAPLAPG001

5902455501444

9000

100



Metal Slat

Listwa metalowa

495(L) x 40(W) mm

INDEX

EAN

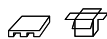

LISTWAMETPG001

5907763087680

6300

70

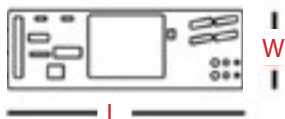

Tool rack

Półka narzędziowa

580(L) x 200(W)mm

INDEX

EAN

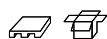

POLKACZAPG001

5902455500966

320

20

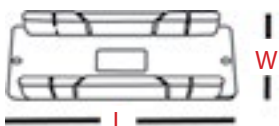

Mitre box

Skrzynka uciosowa

290(L) x 115(W)mm x 70(H)mm

INDEX

EAN

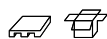

UCIOSCZAPG001

5902455501536

1152

24



Tool drawers

Szufladki narzędziowe

155(L) x 100(W) x 225(H)mm

INDEX

EAN



SZU10XCZAPG001

5902455501529

360

20

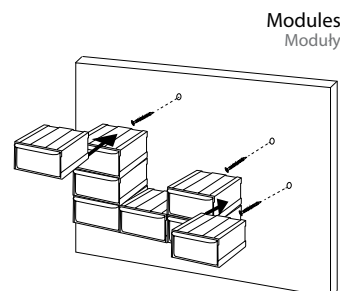

Multi-functional BOXES

Pojemniki
wielofunkcyjne



Ergo latch – durable, aesthetically appealing design. Thanks to its ergonomic manufacture, it makes it possible to fill the container to its capacity, at the same time reducing risk that accessories stored in the container will fall out.

Zapięcie Ergo - estetyczne, mocne. Dzięki ergonomii wykonania umożliwia maksymalne wypełnienie pojemnika, zmniejszając prawdopodobieństwo wypadnięcia gromadzonych w nim akcesoriów.



Handle- comfortable handle enhancing the convenience of transport.

Rączka - wygodna rączka zwiększa komfort użytkowania.



*tools not included/nie zawiera narzędzi



Multi-functional box small

Pojemnik wielofunkcyjny mały

240(L) x 115(W) x 95(H)mm

COLOR	INDEX	EAN		
	PWFMALCZATPG001	5902455503035	672	28





Ergo latch
Zapięcie Ergo
Handle
Rączka
Ergonomic packing
Ergonomiczne pakowanie

Multi-functional box medium

Pojemnik wielofunkcyjny średni

285(L) x 135(W) x 115(H)mm

COLOR	INDEX	EAN		
	PWFSRE CZATPG001	5902455502885	350	25





Ergo latch
Zapięcie Ergo
Handle
Rączka
Ergonomic packing
Ergonomiczne pakowanie

Multi-functional box large

Pojemnik wielofunkcyjny duży

330(L) x 160(W) x 140(H)mm

COLOR	INDEX	EAN		
	PWFDUZCZATPG001	5902455502908	260	26



Ergo latch
Zapięcie Ergo
Handle
Rączka
Ergonomic packing
Ergonomiczne pakowanie



BUILDING

Akcesoria budowlane

Patrol Group offers a broad spectrum of building products: building buckets and containers of various shapes and sizes.

Firma Patrol Group oferuje szeroki wybór artykułów budowlanych. W naszym asortymencie znajdują się wiadra oraz kasty w różnych rozmiarach i kształtach.



BUILDING BUCKETS

Wiadra budowlane



Measure – practical convenience.
Miarka - praktyczne udogodnienie.



Possibility of print your LOGO can be made silk-screen printing on special order.

Możliwość nadrukowania LOGO. Istnieje możliwość wykonania nadruku metodą sitodruku, na specjalne zamówienie.



Strengthened bottom – the bottom of the bucket is supplied with additional ribs, which increases its durability against mechanical shock.

Wzmocnione dno - spód wiadra dodatkowo ożebrowany, co podnosi jego odporność na urazy mechaniczne.



Funnel – practical and convenient during renovations and construction works. It reduces the risk of water or mortar spillage while they are being poured from one container into another.

Lejek - jest praktyczny i wygodny podczas prac remontowych i budowlanych. Zmniejsza prawdopodobieństwo rozlania się wody, czy zaprawy podczas przelewania.

All types of construction buckets are made of highly flexible material resistant to mechanical damages. The buckets are especially well suited for the preparation of all sorts of dry and wet mortars. They come in a variety of sizes. These functional and comfortable buckets are indispensable for all types of construction and renovation works.

Produkty z szerokiej gamy wiader budowlanych, dzięki wysokiej elastyczności tworzywa, z którego zostały wykonane, są odporne na uszkodzenia mechaniczne. Idealne do rozrabiania różnego rodzaju zapraw suchych i mokrych. Dostępne w różnych rozmiarach. Są praktyczne i wygodne, niezbędne przy pracach budowlanych i remontowych.



*Optional
*Opcjonalnie

Plastic handle – better comfort of use.
Tulejka - plastikowy uchwyt podnosi komfort użytkowania.

Bucket Basic 5l with funnel

Wiadro Basic 5l z lejkiem
230(A) x 195(B) x 170(C)mm

INDEX	EAN	
W5LEJBCZAPG001	5902455507408	1650



Measure
Miarka
Strengthened bottom
Wzmocnione dno
Funnel
Lejek

Bucket Basic 12l

Wiadro Basic 12l
325(A) x 235(B) x 245(C)mm

INDEX	EAN	
W12BLEJBCZAPG001	5902455505725	816



Measure
Miarka
Strengthened bottom
Wzmocnione dno

Bucket Basic 12l with funnel

Wiadro Basic 12l z lejkiem
314(A) x 236(B) x 245(C)mm

INDEX	EAN	
W12LEJBCZAPG001	5902455505879	736



Measure
Miarka
Strengthened bottom
Wzmocnione dno
Funnel
Lejek

Bucket Basic 16l

Wiadro Basic 16l
330(A) x 270(B) x 285(C)mm

INDEX	EAN	
W16BLEJBCZAPG001	5907763087451	552



Measure
Miarka
Strengthened bottom
Wzmocnione dno

Bucket Basic 16l with funnel

Wiadro Basic 16l z lejkiem
360(A) x 270(B) x 285(C)mm

INDEX	EAN	
W16LEJBCZAPG001	5901238208624	450



Measure
Miarka
Strengthened bottom
Wzmocnione dno
Funnel
Lejek

Bucket Basic 20l

Wiadro Basic 20l
365(A) x 264(B) x 285(C)mm

INDEX	EAN	
W20BLEJBCZAPG001	5902455505893	540



Measure
Miarka
Strengthened bottom
Wzmocnione dno

Bucket Basic 20l with funnel

Wiadro Basic 20l z lejkiem
365(A) x 265(B) x 285(C)mm

INDEX	EAN	
W20LEJBCZAPG001	5902455505886	450



Measure
Miarka
Strengthened bottom
Wzmocnione dno
Funnel
Lejek



CAPTION
LEGENDA



BUILDING CONTAINERS

Kastry



Metal handle – facilitates the transport of building containers filled with heavy materials.

Uchwyt metalowy - ułatwia transportowanie kastry wypełnionej ciężkim materiałem.



Rope handle – convenient solution allowing for the building container to be held by two people.

Sznurek - wygodne rozwiązanie umożliwiające chwycenie kastry przez dwie osoby.

Construction containers are indispensable at every construction site. The containers are particularly well suited to prepare all sorts of cement and plaster mortars. All containers are produced of a heavy-duty material. They come in two shapes - rectangular and circular, in three sizes each.

Kastry budowlane stanowią niezastąpione narzędzie na każdej budowie. Idealne do przygotowywania różnego rodzaju zapraw cementowych i tynkarskich. Wytworzone z niezwykle wytrzymałego materiału. Dostępne w dwóch kształtach: prostokątnym i okrągłym, każdy w trzech rozmiarach.



Bowl for gypsum – indispensable for minor renovations.

Miska do gipsu - niezbędna przy drobnych pracach remontowych.



Rectangular – ideal for hand and mechanical mixing of mortars. Made of plastic with increased resistance to shock and low temperatures. An item indispensable at every construction site.

Prostokątna - idealna do mieszania ręcznego i mechanicznego zaprawy murarskiej. Wykonana z tworzywa o podwyższonej odporności na uderzenia. Niezbędna rzecz na każdej budowie.



Round – resistant to mechanical damage, thanks to highly flexible materials used for its production. Suitable for mixing and transport of dry and wet mortars.

Okrągła - odporna na uszkodzenia mechaniczne, dzięki wykorzystaniu do produkcji wysokoelastycznych tworzyw. Przeznaczona do mieszania i transportu zapraw suchych i mokrych.



Possibility of print your LOGO - can be made silk-screen printing on special order.

Możliwość nadrukowania LOGA. Istnieje możliwość wykonania nadruku metodą sitodruku, na specjalne zamówienie.

Rectangular
Prostokątna

Rectangular building container 40

Kastra budowlana prostokątna 40

712(L) x 400(W) x 217(H)mm

INDEX	EAN		
KP40CZAPG001	5902455502717	180	3





Rectangular
Prostokątna

Rectangular building container 60

Kastra budowlana prostokątna 60

700(L) x 400(W) x 270(H)mm

INDEX	EAN		
KP60CZAPG001	5902455502724	177	3





Rectangular
Prostokątna

Rectangular building container 80

Kastra budowlana prostokątna 80

785(L) x 485(W) x 300(H)mm

INDEX	EAN		
KP80CZAPG001	5907763082760	200	2



Round
Okrągła

Bowl for gypsum

Miska do gipsu

150(A) x 53(B)mm



INDEX	EAN		
MGIPSCZAPG001	5902455505985	11440	65



Round building container 40 with handle

Kastra budowlana okrągła 40 z uchwytem

508(A) x 288(B)

INDEX	EAN		
KO40UCZAPG001	5902455508535	110	2





Round
Okrągła
Metal handle
Uchwyt metalowy

Round building container 40

Kastra budowlana okrągła 40

508(A) x 288(B)

INDEX	EAN		
KO40CZAPG001	5902455506012	140	2



Round
Okrągła

Round building container 65

Kastra budowlana okrągła 65

594(A) x 336(B)

INDEX	EAN		
KO65CZAPG001	5902455505503	108	2



Round
Okrągła

Round building container 90

Kastra budowlana okrągła 90

651(A) x 369(B)

INDEX	EAN		
KO90CZAPG001	5902455505510	95	2





Round
Okrągła

Round
Okragła
Rope handle
Sznurek

Round building container 40 with rope

Kastra budowlana okrągła 40 ze sznurkiem

508(A) x 288(B)

INDEX	EAN		
KO40SZNCZAPG001	5902455507279	134	2



Round
Okragła
Rope handle
Sznurek

Round building container 65 with rope

Kastra budowlana okrągła 65 ze sznurkiem

594(A) x 336(B)

INDEX	EAN		
KO65SZNCZAPG001	5902455507323	106	2



PATROL[®]

 **GROUP**

See also our other catalogs:
Zobacz również nasze pozostałe katalogi:



**FORMULA
CARBO**



STUFF



TINEM

PATROL[®]
GROUP

Patrol Group Spółka z ograniczoną odpowiedzialnością S.K.A

ul. Koszutki 2, 30-694 Kraków POLAND

TEL: +48 12 376 45 51

FAX: +48 12 376 45 71

E-MAIL: patrol@patrolgroup.com



PATROLGROUP.COM