



**BLUE
CLEAN**®



**ANNOVI
REVERBERI**®
GROUP

CATALOGO CLEANING
DIVISION *CATALOGUE*

IDROPULTRICI LINEA HOME&GARDEN	P 10
<i>Home&Garden line High pressure washers</i>	
Applicazioni Applications	P 12
Pompe Pumps	P 14
SERIE SERIES 1	P 18
SERIE SERIES 3	P 20
SERIE SERIES 4	P 23
SERIE SERIES DSS	P 24
SERIE SERIES DTS	P 30
SERIE SERIES 5	P 36
Accessori Accessories	P 40

IDROPULTRICI LINEA PROFESSIONAL	P 46
<i>Professional line High pressure washers</i>	
PRO COLD	P 47
Applicazioni Applications	P 48
Pompe Pumps	P 52
SERIE SERIES 6	P 66
SERIE SERIES 7	P 74
SERIE SERIES 9	P 78
SERIE SERIES 10	P 84
SERIE SERIES 11	P 93
SERIE SERIES 12	P 96
SERIE SERIES 14	P 100
Accessori Accessories	P 112

PRO HOT	P 122
Applicazioni Applications	P 124
Pompe Pumps	P 126
SERIE SERIES 25	P 134
SERIE SERIES 56	P 136
SERIE SERIES 66	P 138
SERIE SERIES 69	P 139
SERIE SERIES 78	P 140
SERIE SERIES 88	P 141
SERIE SERIES 13	P 142
Accessori Accessories	P 144

ASPIRATORI VACUUM CLEANERS	P 150
Applicazioni Applications	P 152
SERIE SERIES 31	P 156
SERIE SERIES 32	P 157
SERIE SERIES 33	P 158
SERIE SERIES 36	P 159
SERIE SERIES 37	P 160
E12B	P 163
E15	P 164
MID 20	P 165
TOP 20	P 166
M20	P 167

VACUUM CLEANERS PRO	P 168
Applicazioni Applications	P 170
SERIE SERIES 39	P 174
SERIE SERIES 41	P 178
SERIE SERIES 42	P 179
SERIE SERIES 43.44	P 181
SERIE SERIES 43	P 182
SERIE SERIES 44	P 186
SERIE SERIES 47	P 187
SERIE SERIES 48	P 188
SERIE SERIES 42L	P 189
SERIE SERIES 43L	P 190
SERIE SERIES 49	P 191
Accessori Accessories	P 192

POMPE WATER PUMPS	P 202
Applicazioni Applications	P 207
SERIE SERIES ARGP 600P	P 210
SERIE SERIES ARGP 800X	P 211
SERIE SERIES ARGP 1100X	P 212
SERIE SERIES ARGP 600PB	P 216
SERIE SERIES ARGP 800XB	P 217
SERIE SERIES ARGP 1100XB	P 219
SERIE SERIES ARUP 250PC	P 222
SERIE SERIES ARUP 750XC	P 223
SERIE SERIES ARUP 750PT	P 224
SERIE SERIES ARUP 1100XD	P 227
Accessori Accessories	P 228

MERCHANDISING	P 230
LOGISTIC DATA	P 236



**BLUE[®]
CLEAN**

SERIES
TWIN FLOW

Dualtech System

**2 POWER
UNITS,
DOUBLE
CLEANING.**



AP 5.0 TWIN FLOW

5.0 TWIN FLOW

1 2 3 4 5 6 7 8 9 10 11 12 13 14 15 16 17 18 19 20 21 22 23 24 25 26 27 28 29 30 31 32 33 34 35 36 37 38 39 40 41 42 43 44 45 46 47 48 49 50 51 52 53 54 55 56 57 58 59 60 61 62 63 64 65 66 67 68 69 70 71 72 73 74 75 76 77 78 79 80 81 82 83 84 85 86 87 88 89 90 91 92 93 94 95 96 97 98 99 100

0 1 2 3

LA GAMMA COMPLETA AR BLUE CLEAN

I prodotti

Ogni prodotto è descritto in maniera approfondita, soprattutto dal punto di vista delle possibili applicazioni, e corredato da immagini ambientate e video. Nella sezione "Il parere dell'esperto" MR BLUE CLEAN spiega come utilizzare al meglio i prodotti e quali accessori scegliere per ottenere determinati risultati. Un focus particolare è dedicato ai prodotti di punta della gamma, come le idropulitrici Twin Flow.

The products

Each product is described in depth, especially from the point of view of possible applications, and accompanied by set images and videos. In the "Expert opinion" section MR BLUE CLEAN explains how to best use the products and which accessories to choose to obtain certain results. A special focus is dedicated to the leading products in the range, such as the Twin Flow high pressure cleaners.



IDROPULITRICI
HIGH PRESSURE
WASHERS



ASPIRATORI
VACUUM CLEANERS



POMPE AD ACQUA
WATER PUMPS

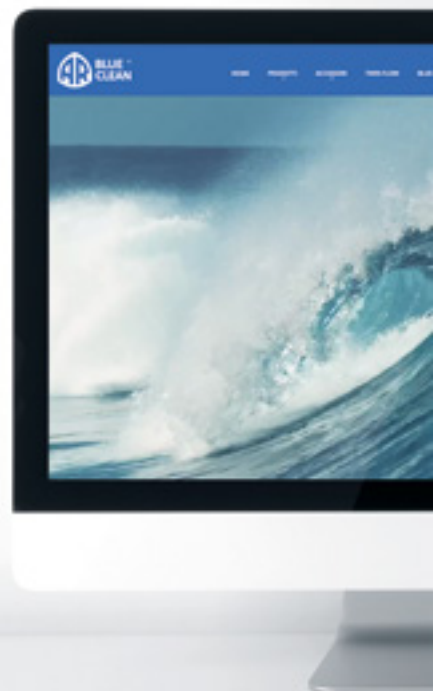

WEB 2.0

AR BLUE CLEAN, brand cardine della divisione cleaning Annovi Reverberi e ampiamente consolidato tra gli operatori del settore cleaning, si affaccia e si consolida anche sul web, grazie ad un piano di comunicazione digital attentamente studiato e pianificato. Elementi principali del progetto, rivolto in primo luogo al consumatore finale, sono il nuovo sito interamente dedicato al brand **www.arblueclean.it**, il Blue Cleaners Blog, la pagina Facebook AR BLUE CLEAN ITALIA e i divertenti video della saga AR BLUE CLEAN FAMILY. Un AR BLUE CLEAN 2.0 pronto a vincere le nuove sfide del mercato digitale!

Social

Anche sulla pagina Facebook AR BLUE CLEAN ITALIA, dedicata al brand, vengono pubblicati argomenti legati al mondo del cleaning a 360°, trattati in chiave moderna e ironica. Le pubblicazioni rilanciano alternativamente gli articoli del blog, i prodotti e le "milestones" aziendali, oltre che i video della Blue Clean Family. L'obiettivo è quello di aumentare la viralità dei contenuti e di portare sempre più persone all'interno del mondo AR BLUE CLEAN.

Also on the Facebook page AR BLUE CLEAN ITALIA, dedicated to the brand, there are topics related to the world of 360° cleaning, treated in a modern and ironic way. The publications alternatively relaunch the articles of the blog, the products and the company "milestones", in addition to the videos of the Blue Clean Family. The goal is to improve the virality of the contents and to bring more and more people into the AR BLUE CLEAN world.

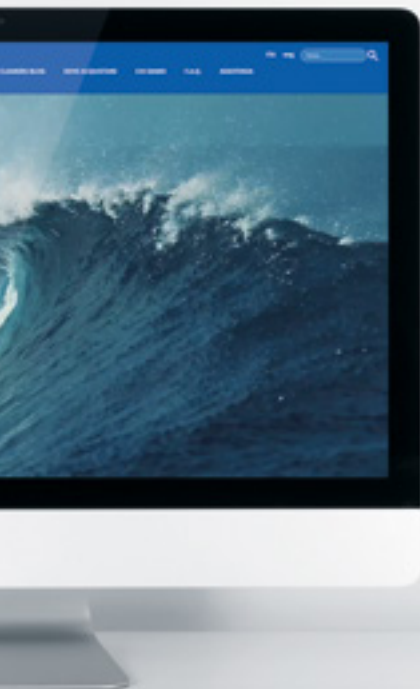

WEB 2.0

AR BLUE CLEAN, a key brand of the Annovi Reverberi cleaning division and widely consolidated among the operators in the cleaning sector, also faces and consolidates itself on the web, thanks to a carefully designed and planned digital communication plan. The main elements of the project, aimed primarily at the final consumer, are the new site entirely dedicated to the **www.arblueclean.it** brand, the Blue Cleaners Blog, the AR BLUE CLEAN ITALIA Facebook page and the amusing videos of the AR BLUE CLEAN FAMILY saga. An AR BLUE CLEAN 2.0 ready to win the new challenges of the digital market!



Come pulire la cuccia del cane: consigli utili per il benessere tuo e del tuo amico a 4 zampe



Come pulire i pavimenti di casa dopo la ristrutturazione grazie al bidone aspiratutto

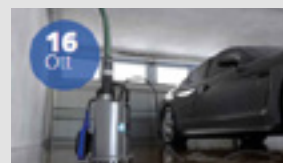

Come prevenire l'allagamento di garage e cantine grazie alle pompe sommerse



Casa sporca e in disordine: che legame c'è con la nostra psicologia e personalità?

Blue Cleaners Blog

Una sezione ricca di suggerimenti, piccoli segreti del mestiere e consigli di pulizia a 360°. Non solo articoli dedicati a come scegliere l'idropulitrice o l'aspiratore più adatto alle proprie esigenze, ma anche approfondimenti relativi alla corretta manutenzione degli spazi home&garden e alle tecniche più avanzate per una pulizia approfondita e professionale senza sforzi.

A section full of suggestions, little secrets of the trade and 360° cleaning tips. Not only articles dedicated to choosing the pressure washer or vacuum cleaner best suited to your needs, but also in-depth information on the correct maintenance of home & garden spaces and the most advanced techniques for a thorough and professional cleaning without effort.

AR Blue Clean FAMILY

Una saga incentrata sul concetto di famiglia e ambientata in situazioni reali in cui tutti possono riconoscersi. Con ironia e naturalezza vengono raccontate le vicende dei protagonisti della BLUE CLEAN FAMILY che si trovano alle prese con i piccoli imprevisti quotidiani; grazie ai prodotti AR BLUE CLEAN, fedeli alleati nelle attività di pulizia outdoor e indoor, riusciranno però a risolvere ogni problema!

A saga focused on the concept of family and set in real situations where everyone can recognize themselves. With irony and naturalness the stories of the BLUE CLEAN FAMILY protagonists who are struggling with the little daily contingencies are told; thanks to AR BLUE CLEAN products, faithful allies in outdoor and indoor cleaning activities, they will be able to solve every problem!

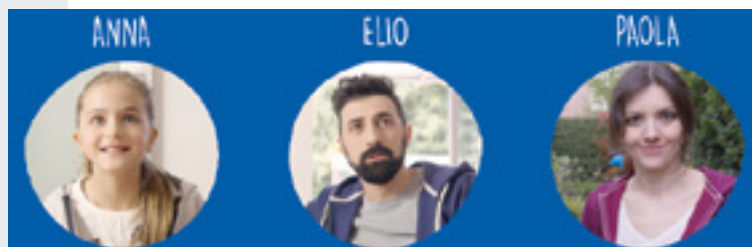

AVANTI I BLU!



THE POWER OF CLEANING

Tra tutti i marchi della divisione cleaning spicca il brand di casa: **AR Blue Clean**. Un marchio che anno dopo anno, è entrato sempre di più sugli scaffali dei punti vendita più specializzati, in Italia come nel resto del mondo grazie ad una gamma di prodotti completa e perfettamente in linea con le esigenze dell'utilizzatore finale. Un marchio pronto ad individuare soluzioni nel settore del cleaning, riuscendo a mantenere una forte attitudine all'innovazione fortemente legata a logiche produttive e timing stringenti della grande distribuzione.



THE POWER OF CLEANING

*The company's own brand, **AR Blue Clean**, leads the way amongst the cleaning division's many brands. Year by year, the brand has won more and more space on the shelves of the most specialised points of sale, in Italy and throughout the world, thanks to a complete product range, perfectly tailored to the end user's needs. A brand ready to find new solutions in the cleaning industry, sustaining a strong focus on innovation while meeting the tight schedules and times demanded by the retail chains.*



INDICE INDEX

IDROPULTRICI LINEA HOME&GARDEN P 10

Home&Garden line High pressure washers

Applicazioni Applications	P 12
Pompe Pumps	P 14
SERIE SERIES 1	P 18
SERIE SERIES 3	P 20
SERIE SERIES 4	P 23
SERIE SERIES DSS	P 24
SERIE SERIES DTS	P 30
SERIE SERIES 5	P 36
Accessori Accessories	P 40

IDROPULTRICI LINEA PROFESSIONAL P 46

Professional line High pressure washers

PRO COLD	P 47
Applicazioni Applications	P 48
Pompe Pumps	P 52
SERIE SERIES 6	P 66
SERIE SERIES 7	P 74
SERIE SERIES 9	P 78
SERIE SERIES 10	P 84
SERIE SERIES 11	P 93
SERIE SERIES 12	P 96
SERIE SERIES 14	P 100
Accessori Accessories	P 112

PRO HOT P 122

Applicazioni Applications	P 124
Pompe Pumps	P 126
SERIE SERIES 25	P 134
SERIE SERIES 56	P 136
SERIE SERIES 66	P 138
SERIE SERIES 69	P 139
SERIE SERIES 78	P 140
SERIE SERIES 88	P 141
SERIE SERIES 13	P 142
Accessori Accessories	P 144

ASPIRATORI VACUUM CLEANERS P 150

Applicazioni Applications	P 152
SERIE SERIES 31	P 156
SERIE SERIES 32	P 157
SERIE SERIES 33	P 158
SERIE SERIES 36	P 159
SERIE SERIES 37	P 160
E12B	P 163
E15	P 164
MID 20	P 165
TOP 20	P 166
M20	P 167

VACUUM CLEANERS PRO P 168

Applicazioni Applications	P 170
SERIE SERIES 39	P 174
SERIE SERIES 41	P 178
SERIE SERIES 42	P 179
SERIE SERIES 43.44	P 181
SERIE SERIES 43	P 182
SERIE SERIES 44	P 186
SERIE SERIES 47	P 187
SERIE SERIES 48	P 188
SERIE SERIES 42L	P 189
SERIE SERIES 43L	P 190
SERIE SERIES 49	P 191
Accessori Accessories	P 192

POMPE WATER PUMPS P 202

Applicazioni Applications	P 207
SERIE SERIES ARGP 600P	P 210
SERIE SERIES ARGP 800X	P 211
SERIE SERIES ARGP 1100X	P 212
SERIE SERIES ARGP 600PB	P 216
SERIE SERIES ARGP 800XB	P 217
SERIE SERIES ARGP 1100XB	P 219
SERIE SERIES ARUP 250PC	P 222
SERIE SERIES ARUP 750XC	P 223
SERIE SERIES ARUP 750PT	P 224
SERIE SERIES ARUP 1100XD	P 227
Accessori Accessories	P 228

MERCHANDISING P 230

LOGISTIC DATA P 236

HOME & GARDEN

Una gamma di prodotti studiati nei minimi dettagli per assicurare facilità di utilizzo ed estrema affidabilità nell'ambiente domestico. Idropultrici ideali per tutta la famiglia, versatili e leggere diventano lo strumento di pulizia ottimale per rimuovere lo sporco da vialetti, balconi, auto, biciclette e moto e diventano strumenti indispensabili per gli appassionati di giardinaggio. Perfette anche per rimuovere, senza fatica, il muschio e le incrostazioni del tempo dalle recinzioni o dagli arredi da esterno, per la pulizia del patio vicino a piscine e per gazebo e lettini solari. E' per questo che ARBC fa la differenza: ha la soluzione ideale per ogni tipo di esigenza.

A range of products designed down to the tiniest detail to ensure ease of use and extreme reliability in the home.

Ideal high pressure washers for all the family: versatile and light weight, they are excellent for removing dirt from paths, balconies, cars, bicycles and motorbikes, and are an essential tool for gardening enthusiasts.

They are also perfect for effortlessly removing moss and deposits left by time from fences or outdoor furniture, and cleaning poolside patios, gazebos and sunbeds.

This is why ARBC makes a real difference: it has the right solution for every type of need.



Applicazioni ed indicatori di prestazioni Home & Garden

Home & Garden performance Indicators & Applications

BLUE CLEAN LEVEL

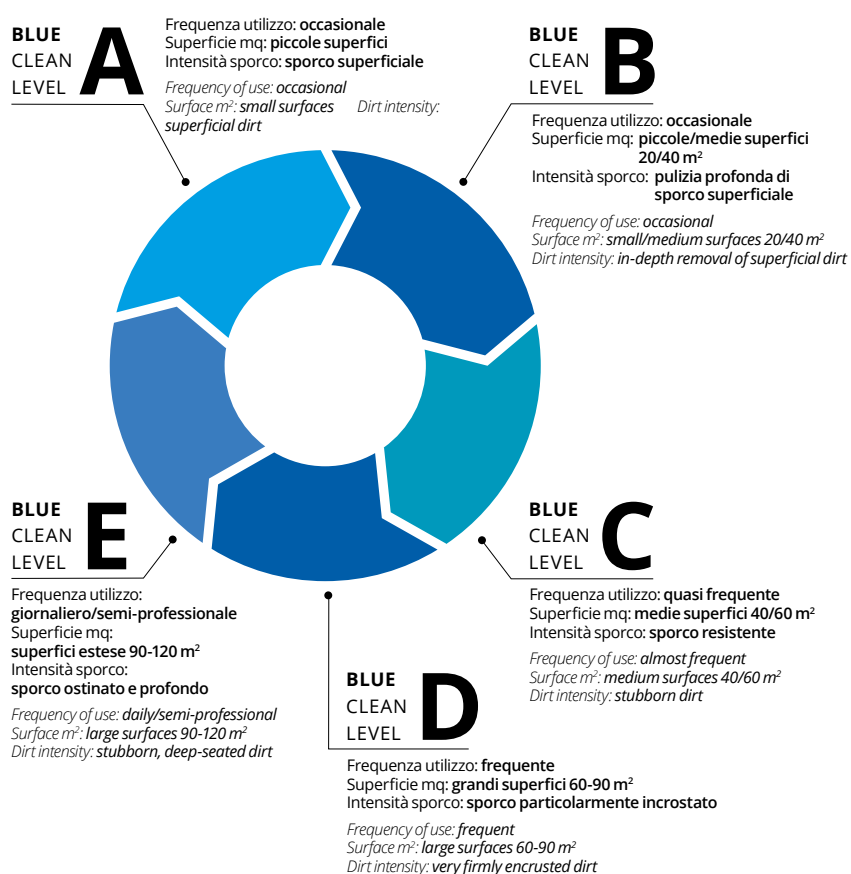

BLUE CLEAN LEVEL ti guida nella scelta del prodotto migliore, in base ad ogni esigenza di pulizia, affiancando ad ogni idropulitrice o aspiratore un'icona di livello lavaggio, insieme con le applicazioni. Ogni prodotto ha le sue caratteristiche tecniche ma anche estetiche-funzionali per soddisfare specifiche necessità del cliente, come la facilità d'uso, la compattezza, l'ergonomia, il peso, la rumorosità e la manovrabilità. Grazie al Blue Clean Level suggeriamo ad ogni cliente la combinazione migliore: è per questo che i prodotti ARBC fanno la differenza.

BLUE CLEAN LEVEL guides you in the choice of the best products for all cleaning needs, by placing a cleaning level icon next to every high pressure washer or vacuum cleaner, together with its applications. Every product has its own technical, stylistic and functional characteristics, to satisfy specific customer requirements, such as ease of use, compact size, labour-saving, weight, noise output and agility. With Blue Clean Level we direct every customer towards the ideal combination: this is why ARBC products make a real difference.

BLUE CLEAN FACTOR



La combinazione ideale tra prestazioni tecniche e configurazione commerciale per poter risolvere al meglio le tue esigenze di pulizia. I prodotti che hanno il BLUE FACTOR sono i migliori, all'interno della loro categoria, per poter pulente, facilità d'utilizzo e prestazioni tecniche. Il mix perfetto per ogni tua esigenza di pulizia.

The ideal combination of technical features and commercial configuration, to deliver the best solution to your cleaning needs. Products with the BLUE FACTOR are best-in-class in cleaning power, ease of use and technical performances. The perfect mix for all your cleaning requirements.



HOME & GARDEN APPLICATIONS

cancellate fencing	panchine benches	giardino garden	biciclette bicycles	moto motorcycle

auto cars	camper recreational vehicles RV's, campers	barche boats	pavimenti flooring, paving stones	scale stairs

piscine pools	utensili tools	casa house	muri walls	tetti roofs

Le idropulitrici della gamma Home & Garden sono la soluzione perfetta per la pulizia degli spazi domestici ed esterni: dimezzano i tempi di pulizia, rendendo il lavoro semplice e di facile esecuzione, grazie anche ad un'ampia selezione di accessori studiata per i diversi campi di applicazione.

Ne è un esempio il patio con serbatoio detergente incorporato, ideale per la pulizia di ampie superfici quali terrazze e bordi piscina, che ottiene risultati uniformi e brillanti alla prima passata!

Le potenti lance con getto rotopower assicurano invece il miglior risultato sull'arredo da esterno, che costantemente esposto alle intemperie è spesso aggredito da sporco ostinato, con un semplice gesto.

Home & Garden range high pressure washers are the perfect solution for cleaning spaces inside and outside the home: washers halve cleaning times, making the whole process simple and easy - thanks also to a wide range of accessories designed for the various fields of use. One example is the patio version, with integral detergent tank, ideal for cleaning large areas such as patios and swimming pool surrounds, which provides gleaming, uniform results in a single pass! In another application, the powerful lances with rotopower jet at the appropriate pressure setting ensure the best results on outdoor furniture, which is constantly exposed to the weather and often accumulates stubborn dirt, with the greatest of ease.

1 Series															
117	●	●	●	●											
143	●	●	●	●											
3 Series															
386	●	●	●	●	●				●	●	●		●		
396	●	●	●	●	●				●	●	●		●		
399	●	●	●	●	●				●	●	●		●		
4 Series															
491					●	●			●	●	●	●	●	●	●
DSS Series															
2.0 PE	●	●	●	●	●	●	●	●	●	●	●	●	●	●	●
3.0 PE	●	●	●	●	●	●	●	●	●	●	●	●	●	●	●
DTS Series															
4.0 TF	●	●	●	●	●	●	●	●	●	●	●	●	●	●	●
5.0 TF	●	●	●	●	●	●	●	●	●	●	●	●	●	●	●
5 Series															
589						●	●	●	●	●	●	●	●	●	●
591						●	●	●	●	●	●	●	●	●	●

Pompe

Pumps

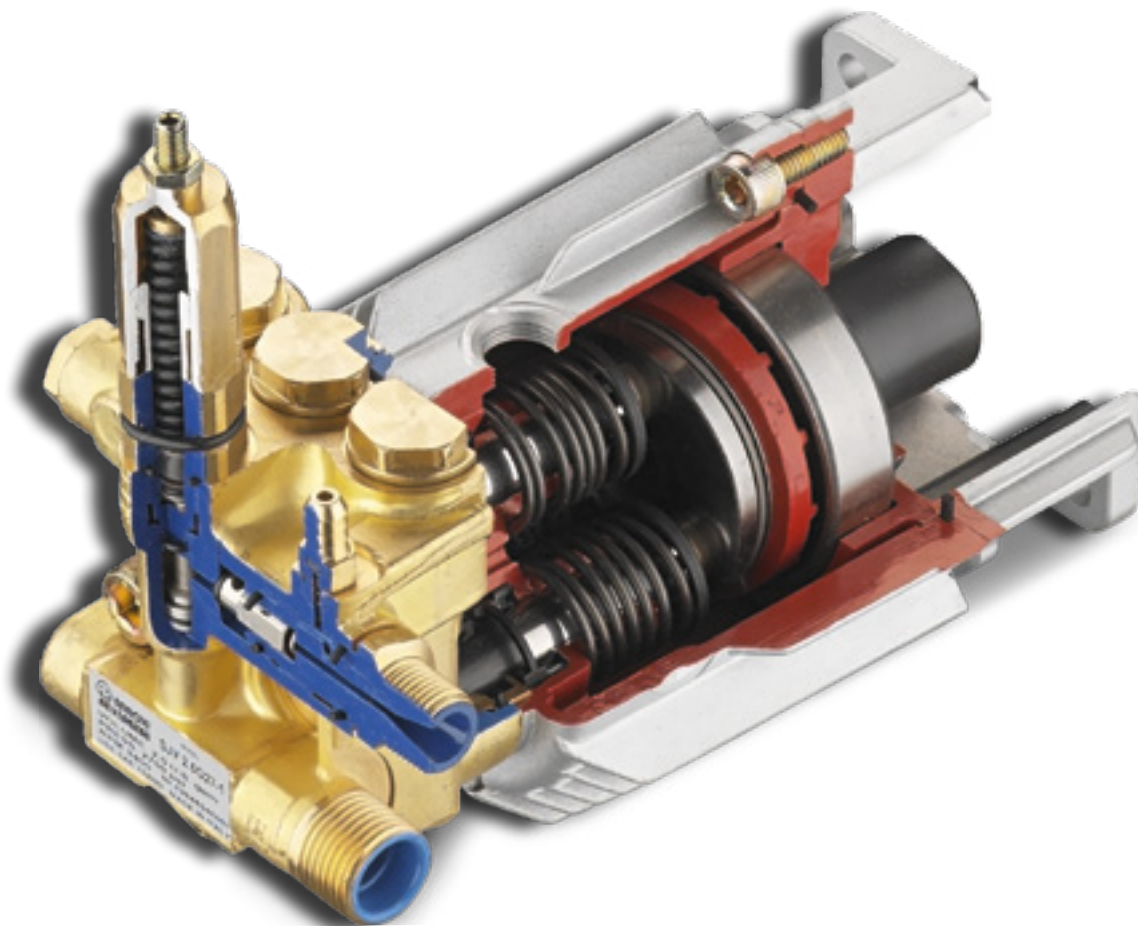

Pompa a piattello oscillante di dimensioni ridotte per utilizzo sia ad asse orizzontale che verticale.
Corpo pompa realizzato in lega d'alluminio per un'alta resistenza.
Il piattello oscillante è sempre realizzato in lega d'alluminio con un particolare trattamento antiusura. I componenti interni sono tutti di dimensioni maggiorate in grado così di garantire una buona affidabilità anche in condizioni di lavoro particolarmente gravoso.

*Compact wobble-plate pump for use both horizontal and vertical.
Aluminium alloy pump body for high strength. The wobble plate is also in aluminium alloy with a special wear-resistant coating. Internal components are all oversized, to guarantee excellent reliability even in particularly heavy-duty conditions.*



- Pompa a 3 pistoni assiali comandati dal piattello oscillante, testa alluminio
- Pistoni in acciaio inox temperato
- Valvola di sicurezza automatica che diminuisce la pressione residua, agevola l'azionamento della leva pistola e riduce l'affaticamento della mano
- Motore elettrico monofase con protezione termica
- Sistema di arresto totale dell'idropulitrice a distanza

- 3 Axial stainless steel pistons wobble-plate pump with aluminium head
- Tempered stainless steel pistons
- Automatic safety valve that decreases the residual pressure, facilitates the operation of the gun lever and reduces hand fatigue
- Single-phase motor with thermal protector
- Remote control for total shut-down of high pressure washer

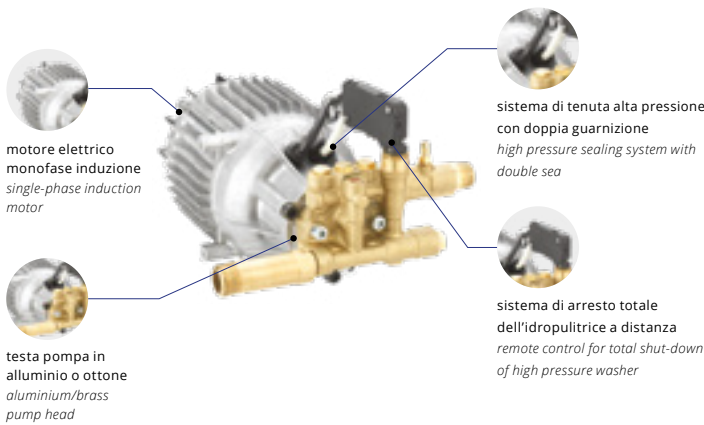
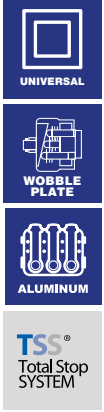

- Pompa a 3 pistoni assiali comandati dal piattello oscillante
- Pistoni in acciaio inox temperato
- Testa pompa in alluminio (Mod.399/491)
- Testa pompa in ottone (Mod.586/588/590)
- Valvola di sicurezza automatica che diminuisce la pressione residua, agevola l'azionamento della leva pistola e riduce l'affaticamento della mano
- Motore elettrico monofase a induzione con protezione termica
- Sistema di arresto totale dell'idropulitrice a distanza
- Sistema di tenuta alta pressione con doppia guarnizione

- 3 Axial stainless steel pistons wobble-plate pump
- Tempered stainless steel pistons
- Aluminium pump head (Mod.399/491)
- Brass pump head (Mod.586/588/590)
- Automatic safety valve that decreases the residual pressure, facilitates the operation of the gun lever and reduces hand fatigue
- Single-phase induction motor with thermal protector
- Remote control for total shut-down of high pressure washer
- High pressure sealing system with double seal



POMPE / PUMPS



	1300 WATT	1500 WATT	1700 WATT	2000 WATT	2200 WATT	2500 WATT	2500 WATT	2700 WATT	2000 WATT	2100 WATT	2500 WATT	2800 WATT
117	●											
143		●										
386			●									
396				●								
399									●			
491										●		
2.0					●							
3.0						●						
4.0 TF							●					
5.0 TF								●				
589											●	
591												●





SERIE 1	P 18
SERIE 3	P 20
SERIE 4	P 23
SERIE DSS	P 24
SERIE DTS	P 30
SERIE 5	P 36



1 Series 117

IDROPULTRICI ALTA PRESSIONE
high pressure washers



porta accessori
built-in accessories
holder



filtro ingresso acqua
ispezionabile
inspectable water
intake filter



portatile
portable



dispositivo click -fast
click-fast connection drive

Caratteristiche Generali

- Pompa a 3 pistoni assiali comandati dal piattello oscillante, testa in alluminio
- Pistoni in acciaio inox temperato
- Valvola di sicurezza automatica con azzeramento della pressione nella testa pompa
- Protezione termica del motore
- Lunghezza cavo elettrico 5 m

General Features

- 3 Axial stainless steel pistons wobble-plate pump with aluminium head
- Tempered stainless steel pistons
- Automatic by-pass valve with pump head pressure discharge
- Motor thermal protector
- Electric cable length 5 m



MOD	COD	MAX		MAX					KG NET	
		bar	psi	l/h	gph	kW	rpm	Hz		
117	13689	110	1600	390	103	1,3	3400	50-60	220-240~	5,6

Accessori standard Standard accessories





porta accessori
built-in accessories
holder

filtro ingresso acqua
ispezionabile
inspectable water
intake filter

battistrada in gomma
rubber wheels

dispositivo click-fast
click-fast connection drive

Caratteristiche Generali

- Carrello a 2 ruote completo di manico
- Pompa a 3 pistoni assiali comandati dal piattello oscillante, testa in alluminio
- Pistoni in acciaio inox temperato
- Valvola di sicurezza automatica con azzeramento della pressione nella testa pompa
- Protezione termica del motore
- Lunghezza cavo elettrico 5 m

General Features

- Two-wheel trolley with handle
- 3 Axial stainless steel pistons wobble-plate pump with aluminium head
- Tempered stainless steel pistons
- Automatic by-pass valve with pump head pressure discharge
- Motor thermal protector
- Electric cable length 5 m



MOD	COD	MAX		MAX					KG NET	
		bar	psi	l/h	gph	kW	rpm	Hz	V	kg
143	13690	120	1740	390	103	1,5	3400	50-60	220-240~	5,9

Accessori standard Standard accessories



41559

41563
(42 cm)

41564

41560 (5 m)

41570

41565



3 Series 386

IDROPULTRICI ALTA PRESSIONE
high pressure washers



TRADE SELECTION



porta accessori
built-in accessories holder

battistrada in gomma
rubber wheels

serbatoio detergente integrato
built-in detergent tank

filtro ingresso acqua ispezionabile
inspectable water intake filter

Caratteristiche Generali

- Carrello a 2 ruote completo di manico
- Pompa a 3 pistoni assiali comandati dal piattello oscillante, testa alluminio
- Pistoni in acciaio inox temperato
- Valvola di sicurezza automatica con azzeramento della pressione nella testa pompa
- Protezione termica del motore
- Aspirazione detergente diretta con serbatoio incorporato
- Capacità del serbatoio detergente 1,4 l
- Lunghezza cavo elettrico 5 m

General Features

- Two-wheel trolley with handle
- 3 Axial stainless steel pistons wobble-plate pump with aluminium head
- Tempered stainless steel pistons
- Automatic by-pass valve with pump head pressure discharge
- Motor thermal protector
- Built-in detergent tank for direct suction
- Detergent tank capacity 1.4 l
- Electric cable length 5 m



MOD	COD	MAX		MAX						KG NET
		bar	psi	l/h	gph	kW	rpm	Hz	V	kg
386	14831	130	1885	420	110	1,7	3400	50-60	220-240~	10,6



Accessori standard Standard accessories



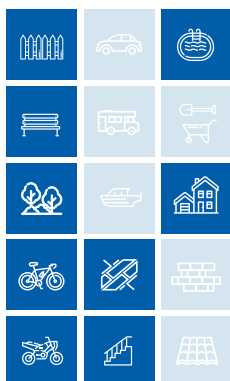

TRADE SELECTION

Caratteristiche Generali

- Carrello a 2 ruote completo di manico ed avvolgitubo (Tubo AP 6 m)
- Pompa a 3 pistoni assiali comandati dal piattello oscillante, testa in alluminio
- Pistoni in acciaio inox temperato
- Valvola di sicurezza automatica con azzeramento della pressione nella testa pompa
- Protezione termica del motore
- Aspirazione detergente diretta con serbatoio incorporato
- Capacità del serbatoio detergente 1,4 l
- Lunghezza cavo elettrico 5 m

General Features

- Two-wheel trolley with handle and hose reel (6 m HP hose)
- 3 Axial stainless steel pistons wobble-plate pump with aluminium head
- Tempered stainless steel pistons
- Automatic by-pass valve with pump head pressure discharge
- Motor thermal protector
- Built-in detergent tank for direct suction
- Detergent tank capacity 1.4 l
- Electric cable length 5 m



MOD	COD	MAX		MAX						KG NET
		bar	psi	l/h	gph	kW	rpm	Hz	V	kg
396	14815	160	2320	440	116	2	2800	50-60	220-240~	13,4

Accessori standard Standard accessories



41561 41563 (42 cm) 3085530



41562 (6 m) 41565 46327 41583





3 Series 399

IDROPULTRICI ALTA PRESSIONE
high pressure washers



Caratteristiche Generali

- Carrello a due ruote completo di manico ed avvolgitubo (Tubo AP 6 m)
- Pompa a 3 pistoni assiali comandati dal piattello oscillante
- Pistoni in acciaio inox temperato
- Valvola di sicurezza automatica con azzeramento della pressione nella testa pompa
- Motore elettrico monofase a induzione con protezione termica
- Aspirazione detergente diretta con serbatoio incorporato
- Capacità del serbatoio detergente 1,4 l
- Lunghezza cavo elettrico 5 m

General Features

- Two-wheel trolley with handle and hose reel (6 m HP hose)
- 3 Axial stainless steel pistons wobble-plate pump
- Tempered stainless steel pistons
- Automatic by-pass valve with pump head pressure discharge
- Single-phase induction motor with thermal protector
- Built-in detergent tank for direct suction
- Detergent tank capacity 1.4 l
- Electric cable length 5 m



MOD	COD	MAX		MAX						KG NET
		bar	psi	l/h	gph	kW	rpm	Hz	V	kg
399	14588	140	2000	450	119	2,0	2800	50	220-240~	21

Accessori standard Standard accessories





manico ergonomico con inserto soft grip
ergonomic handle with soft grip



avvolgitubo in pressione
in pressure hose reel

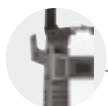

porta accessori
built-in accessories holder



serbatoio detergente integrato
built-in detergent tank



battistrada in gomma
rubber wheels



filtro ingresso acqua ispezionabile
inspectable water intake filter



Caratteristiche Generali

- Carrello a due ruote completo di manico ed avvolgitubo (Tubo armato AP 8 m)
- Pompa a 3 pistoni assiali comandati dal piattello oscillante
- Pistoni in acciaio inox temperato
- Valvola di sicurezza automatica con azzeramento della pressione nella testa pompa
- Motore elettrico monofase a induzione con protezione termica
- Aspirazione detergente diretta con serbatoio incorporato
- Capacità del serbatoio detergente 1,4 l
- Lunghezza cavo elettrico 5 m

General Features

- Two-wheel trolley with handle and hose reel (Reinforced 8 m HP hose)
- 3 Axial stainless steel pistons wobble-plate pump
- Tempered stainless steel pistons
- Automatic by-pass valve with pump head pressure discharge
- Single-phase induction motor with thermal protector
- Built-in detergent tank for direct suction
- Detergent tank capacity 1.4 l
- Electric cable length 5 m



MOD	COD	MAX		MAX						KG NET
		bar	psi	l/h	gph	kW	rpm	Hz	V	kg
491	13694	145	2100	450	119	2,1	2800	50	220-240~	21,5

Accessori standard Standard accessories



41571

41572
(46 cm)

41575
(43 cm)



43987 (8 m)



DUALSPEED SYSTEM

DSS è l'innovativo sistema tecnologico che consente di modulare la performance della idropulitrice attraverso l'utilizzo di un comodo selettore. Le prestazioni del sistema possono essere così selezionate in base alle necessità di utilizzo: la modalità MAX SPEED consente di approfittare di tutta la potenza dell'idropulitrice per soddisfare le richieste più esigenti, la modalità ECO SPEED permette invece di ridurre del 30% il consumo di energia quando le richieste di potenza lavante sono meno rilevanti.

DSS is the innovative technological system which allows you modulating the pressure washer's performance through the use of a convenient selector. The performance of the system can thus be selected based on the needs of use: the MAX SPEED mode allows you to take advantage of all the power of the high-pressure cleaner to meet the most demanding requirements, the ECO SPEED mode can reduce by 30% of the energy consumption when washing power demands are less relevant.

2.0 DUAL SPEED

2
DSS
DUAL SPEED
SYSTEM

NEW

1 ECO SPEED
30% ENERGY SAVING 
■■■■■■■■■■

2 MAX SPEED
FULL PERFORMANCE
■■■■■■■■■■

OFF

2 DSS
DUAL SPEED
SYSTEM

2 MAX
1 ECO





Sistema a doppia velocità.

Dual speed system.

Tramite il POWER SWITCH è possibile selezionare le modalità **ECO SPEED WASHING** e **MAX SPEED WASHING** e modulare il livello di performance dell'idropulitrice adeguandolo ad esigenze di pulizia più leggera, con un notevole risparmio di acqua e di energia (fino al 30%), o più intense in funzione del lavoro da svolgere.

*Using the POWER SWITCH it is possible to select the **ECO SPEED WASHING** and **MAX SPEED WASHING** modes, to modulate the performance level of the pressure washer, adapting it to lighter cleaning needs, with a considerable saving of water and energy (up to 30%), or more intense depending on the work to be done.*

30% ENERGY SAVING



ECO SPEED

30% ENERGY SAVING

Attivando la modalità **ECO SPEED** puoi dedicarti alla pulizia di sporco non aggressivo su superfici esterne in legno, biciclette, mobili da giardino in legno, tessuti esterni, con un **consumo energetico ottimizzato** e un miglior compromesso tra efficacia del lavaggio/consumi.

*By activating **ECO SPEED** mode you can dedicate yourself to cleaning non-aggressive dirt on external wooden surfaces, bicycles, wooden garden furniture, external fabrics, with **optimized energy consumption** and a better compromise between washing / consumption effectiveness.*

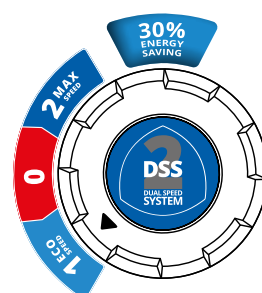

MAX SPEED

FULL PERFORMANCE

Attivando la modalità **MAX SPEED** puoi dedicarti invece alla pulizia di sporco aggressivo su pietra, cemento e mattoni, ringhiere e cancelli in metallo, attrezzi da lavoro e da giardinaggio, automezzi) con un **consumo energetico standard**.

*By activating **MAX SPEED** mode you can dedicate yourself to cleaning aggressive dirt on stone, concrete and bricks, metal railings and gates, work and gardening tools, vehicles) with **standard energy consumption**.*

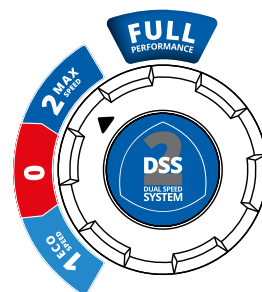

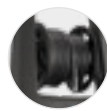

avvolgitubo statico con tubo alta flessibilità 6 m
static hose reel with super flexible hose 6 m

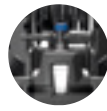

serbatoio detergente alta pressione
high pressure detergent tank



battistrada in gomma
rubber wheels

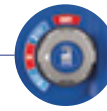

interruttore rotativo a 3 posizioni off/Eco Speed/Full Speed
3 positions rotative switch off/Eco Speed/Full Speed



filtro ingresso acqua ispezionabile
inspectable water intake filter

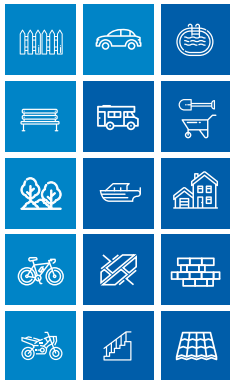

Caratteristiche Generali

- Manico con avvolgitubo statico per tubo AP (6 m)
- Pompa a 3 pistoni assiali comandati dal piattello oscillante, testa in alluminio
- Pistoni in acciaio inox temperato
- Valvola di sicurezza automatica con azzeramento della pressione nella testa pompa
- Motore universale a due velocità con protezione termica
- Lunghezza cavo elettrico 5 m

General Features

- Two-wheel trolley with handle and static hose reel (6 m HP hose)
- 3 Axial stainless steel pistons wobble-plate pumps
- Tempered stainless steel pistons
- Automatic by-pass valve with pump head pressure discharge
- Dual speed single-phase universal motor with thermal protector
- Electric cable length 5 m



MOD	COD	MAX		MAX		MAX				NET
		bar	psi	l/h	gph	kW	rpm	Hz	V	kg
2.0 PE	14986	160	2300	460	122	2,2	2800	50-60	220-240~	10,3

Accessori standard Standard accessories



46328 46332 (42 cm) 46541 (6 m)



46572 3085530 41565 46327





DSS Series 3.0 PE

IDROPULTRICI ALTA PRESSIONE
high pressure washers



TRADE SELECTION

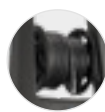
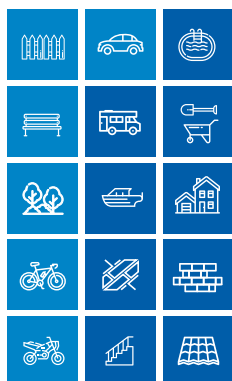

avvolgitubo statico con tubo alta flessibilità 6 m
static hose reel with super flexible hose 6 m



serbatoio detergente alta pressione
high pressure detergent tank



battistrada in gomma
rubber wheels



interruttore rotativo a 3 posizioni off/Eco Speed/Full Speed
3 positions rotative switch off/Eco Speed/Full Speed



filtro ingresso acqua ispezionabile
inspectable water intake filter



Caratteristiche Generali

- Manico con avvolgitubo statico per tubo AP (8 m)
- Pompa a 3 pistoni assiali comandati dal piattello oscillante, testa in alluminio
- Pistoni in acciaio inox temperato
- Valvola di sicurezza automatica con azzeramento della pressione nella testa pompa
- Motore universale a due velocità con protezione termica
- Lunghezza cavo elettrico 5 m

General Features

- Two-wheel trolley with handle and static hose reel (8 m HP hose)
- 3 Axial stainless steel pistons wobble-plate pumps
- Tempered stainless steel pistons
- Automatic by-pass valve with pump head pressure discharge
- Dual speed single-phase universal motor with thermal protector
- Electric cable length 5 m



MOD	COD									
		MAX	MAX		NET					
		bar	psi	l/h	gph	kW	rpm	Hz	V	kg
3.0 PE	14988	180	2600	500	225	2,5	2800	50-60	220-240~	10,5

Accessori standard Standard accessories



46328 46332 (42 cm) 46541 (8 m)



46572 3085530 41565 46540



NEW



DUALTECH SYSTEM

DTS è l'innovativo sistema tecnologico brevettato AR che consente di modulare la performance della idropulitrice attraverso l'utilizzo di 2 gruppi pompa-motore. Le prestazioni del sistema sono notevolmente migliori rispetto a quelle ottenute con una tradizionale idropulitrice a pompa singola. A parità di pressione la portata sinergicamente raggiunta da due pompe, attivabile in modalità Fast Cleaning, consente di raggiungere risultati di pulizia eccellenti anche sullo sporco più ostinato risparmiando tempo e fatica. Grazie alla portata aumentata raddoppia anche la distanza raggiunta dal getto - fino a 5 mt - consentendo lavaggi di superfici estese in altezza con una idropulitrice domestica.

DTS is the innovative technological system, AR patented, which gives you the washing power of two motorpumps when you need it. This system achieves notably superior results when compared to those obtained with a single pump pressure washer. The combined flow rate - triggered by the Fast Cleaning mode - enhances washing results, by intensity and extent, reducing the amount of cleaning time required. Thanks to the combined flow rate, DTS doubles the distance that can be reached by the water jet - up to 5 mt - allowing to easily clean even extended vertical surfaces with a domestic pressure washer.

2 DTS DUALTECH SYSTEM

Interruttore di controllo PU ergonomico
Permette di scegliere la portata più adatta al lavoro di pulizia: normale o migliorata, grazie alla sinergia di due pompe.

Ergonomic PU Switch Control

Allows to choose the most suitable flow rate to fulfill the cleaning task: normal or improved flow, thanks to the double pumps synergy.

POWER UNIT I

Modalità ECO Soft Cleaning:
attiva 1 POWER UNIT per lavaggi leggeri indicati per la pulizia di superfici ridotte evitando inutili sprechi di acqua ed energia

ECO Soft Cleaning Mode:

activate 1 POWER UNIT when the task requires light dirt removal or to wash small surfaces without wasting extra water and energy

POWER UNIT II
Modalità FAST Cleaning:
sfrutta la sinergia di 2 POWER UNITS per eliminare sporco ostinato da grandi superfici o per pulire pareti verticali fino a 5 mt di altezza in breve tempo

FAST Cleaning Mode:
exploit the synergy of 2 POWER UNITS to get rid of the toughest dirt from large surfaces or to clean walls up to 5 mt height in a short amount of time



Prestazioni migliori e risparmio di tempo.

Improve performance. Save time.



Attiva **1 POWER UNIT** per un livello di lavaggio leggero particolarmente indicato per la pulizia di biciclette, moto e auto e adatto anche a staccionate, mobili da giardino e tende da sole.

Activate **1 POWER UNIT** when you need to remove light dirt from bicycles, motorcycles, cars or you want fences, outdoor furniture and sun shades to seem like new.



Sfrutta la sinergia di **2 POWER UNITS** insieme quando devi eliminare macchie e sporco ostinato da pavimentazione di pietra o cemento, rivestimenti e muri di mattoni, attrezzature da costruzione.

Exploit the synergy of **2 POWER UNITS** together when you need to get rid of the toughest dirt and stains from stone and cement flooring, brick walls and sidings, roofs or construction applications.



Maggiore portata per una maggiore potenza prestazionale.

Stronger flow rate for a stronger washing power performance.



Getto doppio, tempi dimezzati con l'esclusivo accessorio Twin Nozzle.

Double water jet, halved cleaning time with Twin Nozzle.

Twin Flow si presenta equipaggiata con l'imperdibile accessorio, incluso nella confezione, utile per incrementare la performance di pulizia di grandi superfici risparmiando tempo e fatica. È particolarmente indicato per il lavaggio di muri in cemento o mattoni, pavimentazioni e piscine.

Twin Flow features the ultimate must-have lance accessory, included inside the packaging, that will boost wide surfaces cleaning performance, saving your time and effort. It is perfect to wash concrete or brick walls, floorings, pools in a very efficient way.

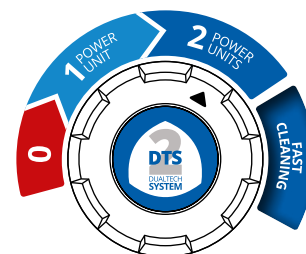
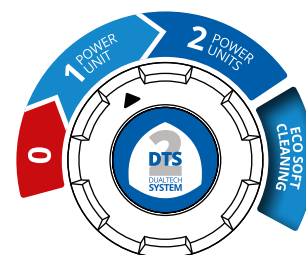



manico telescopico con avvolgitubo statico
telescopic handle with static hose reel

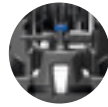

serbatoio detergente alta pressione
high pressure detergent tank



porta accessori integrato
built-in accessory holders

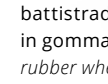

battistrada in gomma
rubber wheels



tubo alta flessibilità 8m
super flexible hose 8m



interruttore rotativo a 3 posizioni
3 positions rotative switch
off/Eco Soft Cleaning/Fast Cleaning



filtro ingresso acqua ispezionabile
inspectable water intake filter



Caratteristiche Generali

- Manico telescopico con avvolgitubo statico per tubo AP (8m)
- 2 Pompe a 3 pistoni assiali comandati dal piattello oscillante, testa in alluminio
- Pistoni in acciaio inox temperato
- Valvola di sicurezza automatica con azzeramento della pressione nella testa pompa
- Doppio motore universale con protezione termica
- Lunghezza cavo elettrico 5m
- Sistema twin nozzle con doppio ugello rotante

General Features

- Two-wheel trolley with handle and hose reel (8m HP hose)
- Two 3 Axial stainless steel pistons wobble-plate pumps
- Tempered stainless steel pistons
- Automatic by-pass valve with pump head pressure discharge
- Twin single-phase universal motor with thermal protector
- Electric cable length 5m
- Twin nozzle system with double rotary nozzle

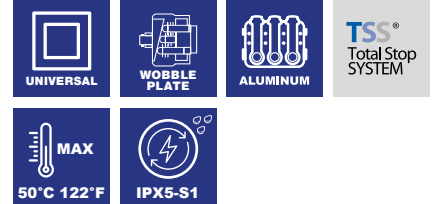

MOD	COD	MAX		MAX					KG NET	
		bar	psi	l/h	gph	kW	rpm	Hz	V	kg
4.0	14792	150	2200	810	214	2,5	3400	50-60	220-230~	14



TWIN NOZZLE

Accessori standard Standard accessories



46328 46332 (42 cm) 46337



46335 (8 m) 46329 (x2) 46330 46344



DTS Series 5.0 TWIN FLOW

IDROPULTRICI ALTA PRESSIONE
high pressure washer



manico telescopico
telescopic handle



serbatoio
detergente
alta pressione
high pressure
detergent tank



porta accessori
integrato
built-in
accessory holders

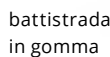

battistrada
in gomma
rubber wheels



avvolgitubo in pressione con tubo
alta flessibilità 8m
in-pressure hose reel with super flexible
hose 8m



interruttore rotativo a 3 posizioni
off/Eco Soft Cleaning/Fast Cleaning
3 positions rotative switch
off/Eco Soft Cleaning/Fast Cleaning



filtro ingresso acqua
ispezionabile
inspectable water intake filter

2
DTS

DUALTECH
SYSTEM

+50%
WPP

Up to
5mt

+70%
FASTER



Blue Clean
Factor

TRADE
SELECTION



Caratteristiche Generali

- Manico telescopico con avvolgitubo in pressione (tubo AP 8m)
- 2 Pompe a 3 pistoni assiali comandati dal piattello oscillante, testa in alluminio
- Pistoni in acciaio inox temperato
- Valvola di sicurezza automatica con azzeramento della pressione nella testa pompa
- Doppio motore universale con protezione termica
- Lunghezza cavo elettrico 5m
- Sistema twin nozzle con doppio ugello rotante
- Ugello multi funzione 5 in 1

General Features

- Two-wheel trolley with handle and in-pressure hose reel (8m HP hose)
- Two 3 Axial stainless steel pistons wobble-plate pumps
- Tempered stainless steel pistons
- Automatic by-pass valve with pump head pressure discharge
- Twin single-phase universal motor with thermal protector
- Electric cable length 5m
- Twin nozzle system with double rotary nozzle
- Multifunction 5 in 1 nozzle



MOD	COD	MAX		MAX					KG NET	
		bar	psi	l/h	gph	kW	rpm	Hz	V	kg
5.0	14793	160	2300	850	225	2,7	3400	50-60	220-230~	14,6



Accessori standard Standard accessories



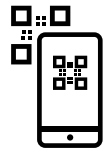



5 Series 589

IDROPULTRICI ALTA PRESSIONE
high pressure washers



TRADE SELECTION



manico telescopico
telescopic handle

avvolgitubo in pressione
in pressure hose reel

porta accessori
built-in accessories holder

serbatoio detergente integrato
built-in detergent tank

battistrada in gomma
rubber wheels

filtro ingresso acqua ispezionabile
inspectable water intake filter

regolazione della pressione
pressure adjustment

Caratteristiche Generali

- Carrello a due ruote completo di manico ed avvolgitubo (Tubo armato AP 10 m)
- Pompa a 3 pistoni assiali comandati dal piattello oscillante
- Pistoni in acciaio inox temperato
- Valvola di sicurezza automatica con azzeramento della pressione nella testa pompa
- Manometro
- Motore elettrico monofase a induzione con protezione termica
- Lunghezza cavo elettrico 5 m
- Regolazione della pressione
- Manometro

General Features

- Two-wheel trolley with handle and hose reel (Reinforced 10 m HP hose)
- 3 Axial stainless steel pistons wobble-plate pump
- Tempered stainless steel pistons
- Automatic by-pass valve with pump head pressure discharge
- Pressure gauge
- Single-phase induction motor with thermal protector
- Electric cable length 5 m
- Pressure adjustment
- Pressure gauge



MOD	COD	MAX	MAX					NET		
		bar	psi	l/h	gph	kW	rpm	Hz	V	kg
589	14989	170	2500	500	132	2,5	2800	50	220-230~	24,4

Accessori standard Standard accessories



46575

46576

46578



46580



46581 (10 m)



NEW



TRADE SELECTION

Caratteristiche Generali

- Carrello a due ruote completo di manico ed avvolgitubo (Tubo armato AP 8 m)
- Pompa a 3 pistoni assiali comandati dal piattello oscillante
- Pistoni in acciaio inox temperato
- Valvola di sicurezza automatica con azzeramento della pressione nella testa pompa
- Manometro
- Motore elettrico monofase a induzione con protezione termica
- Lunghezza cavo elettrico 5 m
- Regolazione della pressione
- Manometro

General Features

- Two-wheel trolley with handle and hose reel (Reinforced 8 m HP hose)
- 3 Axial stainless steel pistons wobble-plate pump
- Tempered stainless steel pistons
- Automatic by-pass valve with pump head pressure discharge
- Pressure gauge
- Single-phase induction motor with thermal protector
- Built-in detergent tank for direct suction
- Electric cable length 5 m
- Pressure adjustment
- Pressure gauge

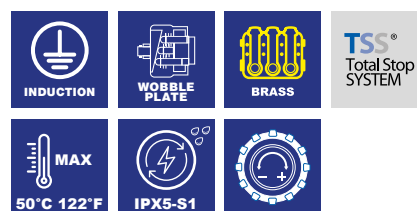

MOD	COD	MAX	MAX		NET
		bar	psi	l/h gph	kW rpm Hz V kg
591	14990	180	2600	600 159	2,8 2800 50 220-230~ 25

Accessori standard Standard accessories







ACCESSORI & DETERGENTI

Accessories & detergents





1.3.4.5 Series

ACCESSORI
accessories

			1 Series	3 Series	4 Series	DSS Series	DTS Series	5 Series						
			117	143	386	396	399	491	2.0 PE	3.0 PE	4.0 TF	5.0 TF	589	591
Pistola Trigger gun		41559	S	S										
		41561		S	S	S								
		41571					S							
		46328						S	S	S	S			
		46575											S	S
Prolunga lancia Lance extension		41563 (42 cm)	S	S	S	S								
		46332 (42 cm)					S	S	S	S				
Portatestina doppio Twin nozzle holder		46337							S	S				
Testina getto regolabile Adjustable jet nozzle		41564	S	S	S									
		46327			S		S							
		46540					S							
		46330							S	O				
Testina getto rotante Rotary jet nozzle		41565	O	S	S	S	S	S						
		46329							S	S				
Testina cinque in uno Five in One nozzle		46338	O	O		O								
		46341			O		O							
		46544						O						
		46342							O	S				
Lancia getto regolabile Lance with adjustable spray nozzle		46333 (48 cm)		S										
		41572 (46 cm)				S								
		46576										S		
		46577											S	
Lancia getto rotante Rotary lance		41567 (48 cm)		S										
		41575 (43 cm)				S								
		46578									S			
		46579										S		

			1 Series	3 Series	4 Series	DSS Series	DTS Series	5 Series						
			117	143	386	396	399	491	2.0 PE	3.0 PE	4.0 TF	5.0 TF	589	591
Tubo AP Hose HP		46348 (3 m)	S											
		41560 (5 m)	O	S										
Tubo AP Hose HP		46541 (6 m)						S	S					
		46335 (8 m)									S	S		
Tubo AP Hose HP		41562 (6 m)		S	S	S								
Tubo armato AP Reinforced hose HP		43987 (8 m)						S						
		46581 (10 m)											S	S
Prolunga tubo AP Extension HP hose		41585 (8 m)	O	O										
		41586 (8 m)		O	O	O								
		46336 (8 m)							O	O	O	O		
		41587 (8 m)						O						
Prolunga tubo armato AP Extension reinforced HP hose		41582 (8 m)											O	O
		41583		S	S	S								
Testina schiumogena Foam jet nozzle		41570	S	S										
Kit schiumogeno Foam lance bottle		46343 (750 ml)	O	O	O	O	O							
		46572 (400 ml)						S	S					
		46344 (500 ml)								S	S			
		46580											S	S

1.3.4.5 Series

ACCESSORI
accessories



		1 Series	143	386	396	399	491	2.0 PE Series	3.0 PE Series	4.0 TF Series	5.0 TF Series	589	591
Kit schiumogeno alta pressione <i>High pressure foam lance bottle</i>		46345 (750 ml)					○						
Kit filtro acqua <i>Water filter kit</i>		41593	○	○	○	○	○	○	○	○	○	○	○
Filtro acqua ispezionabile <i>Inspectable water filter</i>		41663 (3 pcs)	S	S	S	S	S	○	○	S	S	S	S
Kit attacco rapido <i>Click fast kit</i>		41580	○	○	○	○	○	○	○	○	○	○	○
Kit adattatori <i>Adaptors kit</i>		41758	○	○	○	○	○	○	○	○	○	○	○
Kit adattatori accessori <i>Accessories adapters kit</i>		41890*	○	○	○	○		○	○			○	○
Adattatore snodato per testine <i>Adjustable head nozzle adaptor</i>		46009	○	○		○	○	○	○				
Kit lancia sottoscocca <i>Underbody lance kit</i>		41755 (45 cm)		○									
		46354 (80 cm)				○						○	○
Kit estensione lancia 1,6 m <i>Extension lance kit 1,6 m</i>		46355	○	○	○	○		○	○	○	○		
Lancia multifunzione <i>Multifunction lance</i>		46349 (48 cm)	○	○	○	○			○				
		46352 (48 cm)			○				○				
		46545 (48 cm)										○	
Kit lancia sabbiant <i>Sandblasting lance kit</i>		41760 (50 cm)	○	○	○	○		○	○				
Kit lancia sabbiane PRO <i>Sandblasting lance kit PRO</i>		41591 (50 cm)				○							
		41762 (50 cm)										○	○
Sabbia calibrata e filtrata <i>Calibrated, filtered sand</i>		3207 (5 Kg)	○	○	○	○	○	○	○	○	○	○	○
		41770 (25 Kg)	○	○	○	○	○	○	○	○	○	○	○

		1 Series	143	386	396	399	491	2.0 PE Series	3.0 PE Series	4.0 TF Series	5.0 TF Series	589	591
Kit aspirazione acqua <i>Water suction kit</i>		41592	○	○	○	○	○	○	○	○	○	○	○
Spazzola fissa <i>Fixed brush</i>		41577	○	○	○	○	○	○	○	○	○	○	○
Spazzola fissa <i>Fixed brush</i>		46353	○	○	○	○	○	○	○	○	○		
Spazzola rotante <i>Rotary brush</i>		41578	○	○	○	○	○	○	○	○	○	○	○
Spazzola lavante <i>Power brush</i>		46361	○	○	○	○	○	○				○	○
		46362					○	○					
									○	○			
Kit pulizia tubazioni <i>Pipe drain kit</i>		43827 (8 m)	○	○	○	○							
		41588 (10 m)	○	○	○	○	○	○	○	○	○	○	○
		41693 (16 m)	○	○	○	○	○	○	○	○	○	○	○
Lavapavimenti d. 25 cm <i>Patio cleaner d. 25 cm</i>		46356	○	○	○		○	○	○				
		3085530						S	S	S	S		
Lavapavimenti d. 30 cm con serbatoio detergente <i>Patio cleaner d. 30 cm with detergent tank</i>		41581	○	○	○	○	○	○	○	○	○		
		41687										○	○
Lavapavimenti d. 30 cm <i>Patio cleaner d. 30 cm</i>		46358	○	○	○	○	○	○	○	○	○		
		46359										○	○

(* Adattatori universali da collegarsi ad accessori con attacco a baionetta AR Blue Clean, compatibili con idropultrici ad alta pressione aventi analoghe prestazioni di quelle indicate in tabella

(* Universal adaptors to be connected to Blue Clean accessories with bayonet fitting, suitable for pressure washers with similar specifications of the models listed in the chart



Detergenti. *Detergent*



AUTO&BARCHE *cars and boats*

Detergente pronto all'uso.
Ideale per parabrezza e superfici metalliche delicate.
Rimuove lo sporco oleoso senza lasciare aloni.
Piacevole fragranza alla mente piperita.
Formulazione esente da EDTA e NTA e conservanti privi di formaldeide ed alogeni.

*Ready-to-use cleaner.
Ideal for windscreens and delicate metal surfaces. Removes oily dirt without leaving smears.
Pleasant peppermint scent.
Formula free from EDTA and NTA and preservatives without formaldehyde or halogens.*

Cod. 41872



BICI&MOTO *bicycle and motorbikes*

Detergente pronto all'uso.
Ideale per la pulizia di superfici delicate quali la vernice di telai di bici e moto.
Rimuove alla perfezione tracce di fango ed olio.
Piacevole fragranza di bouquet fiorito.
Formulazione esente da EDTA e NTA e conservanti privi di formaldeide ed alogeni.

*Ready-to-use cleaner.
Ideal for cleaning delicate surfaces such as the paintwork of bike and motorbike frames. Removes mud and oil residues to perfection.
Pleasant floral scent.
Formula free from EDTA and NTA and preservatives without formaldehyde or halogens.*

Cod. 41871



DECKING *wood surfaces*

Detergente pronto all'uso.
Pulisce senza danneggiare tutte le pavimentazioni in decking e legno, sia trattato che naturale.
Piacevole fragranza alla vaniglia.
Formulazione esente da EDTA e NTA e conservanti privi di formaldeide e alogeni.

*Ready-to-use cleaner.
Cleans all treated and untreated decking and wood floors without damaging surfaces.
Pleasant vanilla scent.
Formula free from EDTA and NTA and preservatives without formaldehyde or halogens.*

Cod. 43487



PANNELLI SOLARI *solar panels*

Detergente pronto all'uso.
Ideale per la pulizia di pannelli solari ed impianti fotovoltaici.
Piacevole fragranza di lavanda.
Formulazione esente da EDTA e NTA e conservanti privi di formaldeide ed alogeni.

*Ready-to-use cleaner.
Ideal for cleaning solar panels and photovoltaic systems.
Pleasant lavender scent.
Formula free from EDTA and NTA and preservatives without formaldehyde or halogens.*

Cod. 43485



ERBA SINTETICA *synthetic grass*

Detergente pronto all'uso.
Ideale per pulire superfici in erba sintetica. Rimuove lo sporco che si annida alla base senza danneggiarne la consistenza e la forma.
Piacevole fragranza di pino selvatico.
Formulazione esente da EDTA e NTA e conservanti privi di formaldeide ed alogeni.

*Ready-to-use cleaner.
Ideal for cleaning artificial turf surfaces. Removes the dirt that builds up at the base without damaging the turf's consistency or shape.
Pleasant wild pine scent.
Formula free from EDTA and NTA and preservatives without formaldehyde or halogens.*

Cod. 43484



MURI&PIETRE *walls and stones*

Detergente pronto all'uso.
Pulisce le superfici in pietra naturale, in sasso e facciate in muratura, rimuovendo anche lo sporco più ostinato.
Fragranza di sapone di Marsiglia.
Formulazione esente da EDTA e NTA e conservanti privi di formaldeide ed alogeni.

*Ready-to-use cleaner.
Cleans natural and dressed stone surfaces and brickwork facades, removing even the most stubborn dirt.
Savon de Marseille scent.
Formula free from EDTA and NTA and preservatives without formaldehyde or halogens.*

Cod. 43486





TENDE DA SOLE *awnings*

Detergente pronto all'uso. Ideale per la pulizia di teli in tessuto e plastica. Rimuove con facilità lo sporco che si accumula sulle strutture all'aperto. Piacevole fragranza agli agrumi. Formulazione esente da EDTA e NTA e conservanti privi di formaldeide ed alogeni.

Ready-to-use cleaner. Ideal for cleaning fabric and plastic blinds. Easily removes the dirt that builds up on outdoor structures. Pleasant citrus scent. Formula free from EDTA and NTA and preservatives without formaldehyde or halogens.

Cod. 43483

11e



VETRI *glass*

Detergente pronto all'uso. Ideale per la pulizia di superfici in vetro, trasparenti o riflettenti. Rimuove lo sporco senza lasciare aloni e striature. Delicata fragranza fresco di pulito. Formulazione esente da EDTA e NTA e conservanti privi di formaldeide ed alogeni.

Ready-to-use cleaner. Ideal for cleaning clear or reflecting glass surfaces. Removes dirt without leaving smears or streaks. Delicate, clean scent. Formula free from EDTA and NTA and preservatives without formaldehyde or halogens.

Cod. 43488

11e



UNIVERSALE *universal*

Detergente pronto all'uso. Rimuove facilmente lo sporco accumulato sulle strutture outdoor in plastica, ceramica e metallo. Delicata fragranza di pesca. Formulazione esente da EDTA e NTA e conservanti privi di formaldeide ed alogeni.

Ready-to-use cleaner. Easily removes the dirt that builds up on outdoor plastic, ceramic and metal structures. Delicate peach scent. Formula free from EDTA and NTA and preservatives without formaldehyde or halogens.

Cod. 41870 (1l)

11e

Cod. 43491(5l)

51e



**LINEA
PROFES-
SIONAL**

Professional line

PRO COLD



Prodotti tecnicamente pensati per resistere ad utilizzi gravosi e continuativi. Una gamma completa per soddisfare le diverse esigenze lavorative di professionisti che ricercano ogni giorno qualità, prestazioni affidabili e velocità d'utilizzo. In due parole la qualità Annovi Reverberi. È questo il denominatore comune della gamma PRO COLD – idropulitrici ad acqua fredda costruite con pompe ad elevate prestazioni per garantire alla macchina una extra durata anche in condizioni di utilizzo gravose ed estreme. Ideali per il settore Automotive e per cantieri edili.

Products engineered to withstand continual heavy-duty use. A complete range to meet the various working needs of professionals who need quality, reliable performance and fast operation, day in, day out. In other words, Annovi Reverberi quality. This is the common denominator of the PRO COLD range – cold water high pressure washers built with high-performance pumps to guarantee an exceptionally long lifetime even in extreme, heavy-duty conditions. Ideal for the automotive industry and construction sites.

Applicazioni ed indicatori di prestazioni

PRO COLD

PRO COLD performance Indicators & Applications

BLUE CLEAN PRO LEVEL

○ LIGHTPRO

Fascia di idropultrici progettate per utilizzatori esperti che hanno necessità di eseguire lavori di pulizia abbastanza frequenti e che richiedono una abbondante riserva di potenza.

High pressure washer category designed for skilled users tackling cleaning quite frequent jobs operations which need plenty of power in reserve.

● HEAVYPRO

Fascia di idropultrici progettate per professionisti che hanno necessità di eseguire lavori di pulizia molto frequenti che richiedono le massime prestazioni.

High pressure cleaner category designed for professionals, dealing with cleaning high frequent jobs that need the very highest-performing appliances.

BLUE CLEAN FACTOR



La combinazione ideale tra prestazioni tecniche e configurazione commerciale per poter risolvere al meglio le tue esigenze di pulizia. I prodotti che hanno il BLUE FACTOR sono i migliori, all'interno della loro categoria, per poter pulente, facilità d'utilizzo e prestazioni tecniche. Il mix perfetto per ogni tua esigenza di pulizia.

The ideal combination of technical features and commercial configuration, to deliver the best solution to your cleaning needs. Products with the BLUE FACTOR are best-in-class in cleaning power, ease of use and technical performances. The perfect mix for all your cleaning requirements.





Applicazioni PRO COLD

PRO COLD
Applications

PROFESSIONAL APPLICATIONS

Annovi Reverberi ha realizzato una gamma di prodotti, ideale per gli artigiani più esigenti, che ben si coniuga alle loro esigenze professionali. Estremamente versatili i prodotti della linea PRO rispondono perfettamente alle necessità lavorative di artigiani idraulici, carrozzieri, muratori; un costante supporto a ciascuna professione che consente risparmio tempo ma soprattutto fatica. Utilizzo intuitivo, accessori professionali e manovrabilità estrema rendono i prodotti ARBC la miglior scelta per la categoria.

Annovi Reverberi has produced a range of products ideal for the most demanding craftsmen, carefully tailored to their professional requirements. Extremely versatile, the PRO line products are the perfect fit for the working needs of plumbers, car body repair workshops and builders; constant support for each trade, saving time and above all effort. User-friendliness, professional accessories and extremely easy handling make ARBC products the right choice for this category.



edilizia
construction



**agricoltura
zootecnica**
agriculture
zootechny



artigianato
crafts



car wash



automotive



6 Series

610		●	●	●		
613		●	●	●		
614		●	●	●		
615		●	●	●		
613K		●	●	●		
614K		●	●	●		
615K		●	●	●		
625		●	●	●		
630		●	●	●		
650		●	●	●		
630K		●	●	●		
670		●	●	●		
671		●	●	●		
672		●	●	●		

7 Series

737		●	●	●		
747		●	●	●		
767		●	●	●		
780		●	●	●	●	●
787		●	●	●	●	●
797		●	●	●	●	●

8 Series

930		●	●	●	●	●
940		●	●	●	●	●
950		●	●	●	●	●
970		●	●	●	●	●
990		●	●	●	●	●

10 Series						
1000K		●	●	●		
1001K		●	●	●		
1003K		●	●	●	●	
1004K		●	●	●	●	
1001		●	●	●		
1003		●	●	●	●	
1004		●	●	●	●	●
1007		●	●	●	●	●
1008		●	●	●	●	●
1010N		●	●	●	●	●
1015N		●	●	●	●	●
1018		●	●	●	●	●
1018H		●	●	●	●	●
11 Series						
1120		●	●	●	●	●
1125		●	●	●	●	●
1130		●	●	●	●	●

12 Series						
1230		●	●	●	●	●
1240		●	●	●	●	●
1250S		●	●	●	●	●
1255		●	●	●	●	●
1260S		●	●	●	●	●
1270S		●	●	●	●	●
1280S		●	●	●	●	●
1290S		●	●	●	●	●
14 Series						
1415		●	●	●		
1425		●	●	●		
1440		●	●	●		
1435		●	●	●		
1450		●	●	●	●	
1445		●	●	●	●	
1460		●	●	●	●	●
1475		●	●	●	●	●
1480		●	●	●	●	●
1490		●	●	●	●	●
1492		●	●	●	●	●

HRM

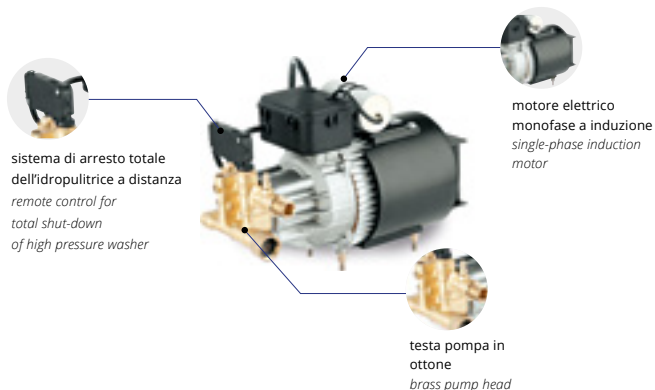

- Pompa a 3 pistoni assiali comandati dal piattello oscillante, testa ottone
- Pistoni in acciaio inox temperato
- Valvola di sicurezza automatica con azzeramento della pressione nella testa pompa
- Motore elettrico monofase a induzione con protezione termica
- Sistema di arresto totale dell'idropultrice a distanza

- 3 Axial stainless steel pistons wobble-plate pump with brass head
- Tempered stainless steel pistons
- Automatic by-pass valve with pump head pressure discharge
- Single-phase induction motor with thermal protector
- Remote control for total shut-down of high pressure washer



HPZ



- Pompa a 3 pistoni assiali comandati dal piattello oscillante, testa ottone
- Pistoni in acciaio inox temperato
- Valvola di sicurezza automatica con azzeramento della pressione nella testa pompa
- Motore elettrico monofase a induzione con protezione termica
- Sistema di arresto totale dell'idropultrice a distanza

- 3 Axial stainless steel pistons wobble-plate pump with brass head
- Tempered stainless steel pistons
- Automatic by-pass valve with pump head pressure discharge
- Single-phase induction motor with thermal protector
- Remote control for total shut-down of high pressure washer



HPV

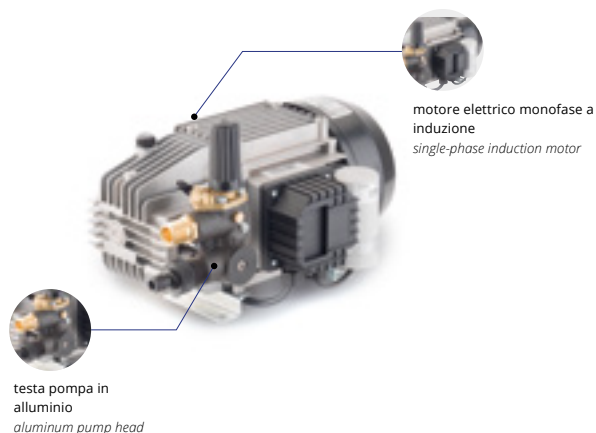

- Pompa a 3 pistoni in ceramica con sistema biella-manovella, testa pompa in alluminio
- Valvola di sicurezza automatica con azzeramento della pressione nella testa pompa
- Motore elettrico monofase a induzione con protezione termica

- Triplex pump with ceramic pistons and connecting rod system with aluminium pump head
- Automatic by-pass valve with pump head pressure discharge
- Single-phase induction motor with thermal protection



HPV-O

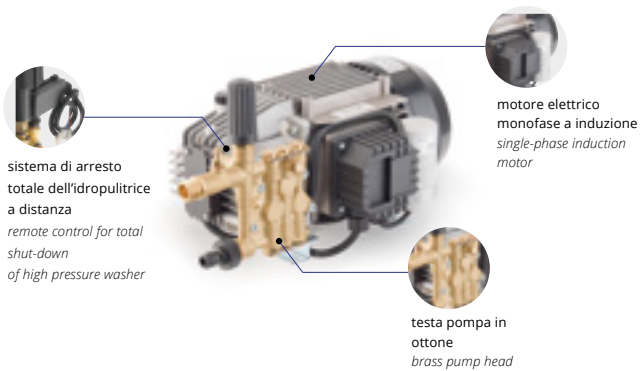

- Pompa a 3 pistoni in ceramica con sistema biella-manovella, testa pompa in alluminio
- Valvola di sicurezza automatica con azzeramento della pressione nella testa pompa
- Motore elettrico monofase a induzione con protezione termica
- Sistema di arresto totale dell'idropulitrice a distanza

- *Triplex pump with ceramic pistons and connecting rod system with aluminum pump head*
- *Automatic by-pass valve with pump head pressure discharge*
- *Single-phase induction motor with thermal protection*
- *Remote control for total shut-down of high pressure washer*



HPE



- Pompa a 3 pistoni in ceramica con sistema biella-manovella
- Testa pompa in alluminio (Mod.625)
- Testa pompa in ottone (Mod.630/630K/650/767)
- Valvola di sicurezza automatica con azzeramento della pressione nella testa pompa
- Motore elettrico monofase a induzione con protezione termica
- Sistema di arresto totale dell'idropulitrice a distanza (Mod.767)

- *Triplex pump with ceramic pistons and connecting rod system*
- *Aluminum pump head (Mod.625)*
- *Brass pump head (Mod.630/630K/650/767)*
- *Automatic by-pass valve with pump head pressure discharge*
- *Single-phase induction motor with thermal protection*
- *Remote control for total shut-down of high pressure washer (Mod.767)*



HJRS-O



- Pompa a 3 pistoni in ceramica con sistema biella-manovella, testa pompa in ottone
- Valvola di sicurezza automatica con azzeramento della pressione nella testa pompa
- Motore elettrico monofase a induzione con protezione termica
- Sistema di arresto totale dell'idropulitrice a distanza
- Aspirazione acqua da serbatoio con funzione autoadescente

- *Triplex pump with ceramic pistons and connecting rod system with brass pump head*
- *Automatic by-pass valve with pump head pressure discharge*
- *Single-phase induction motor with thermal protection*
- *Remote control for total shut-down of high pressure washer*
- *Inlet water suction from tank by self priming function*



HRS



- Pompa a 3 pistoni in ceramica con sistema biella-manovella, testa pompa in ottone
- Valvola di sicurezza automatica con azzeramento della pressione nella testa pompa
- Motore elettrico monofase a induzione con protezione termica
- Motore elettrico trifase a induzione con protezione termica
- Sistema di arresto totale dell'idropulitrice a distanza

- *Triplex pump with ceramic pistons and connecting rod system with brass pump head*
- *Automatic by-pass valve with pump head pressure discharge*
- *Single-phase induction motor with thermal protection*
- *Three-phase induction motor with thermal protection*
- *Remote control for total shut-down of high pressure washer*



HRC

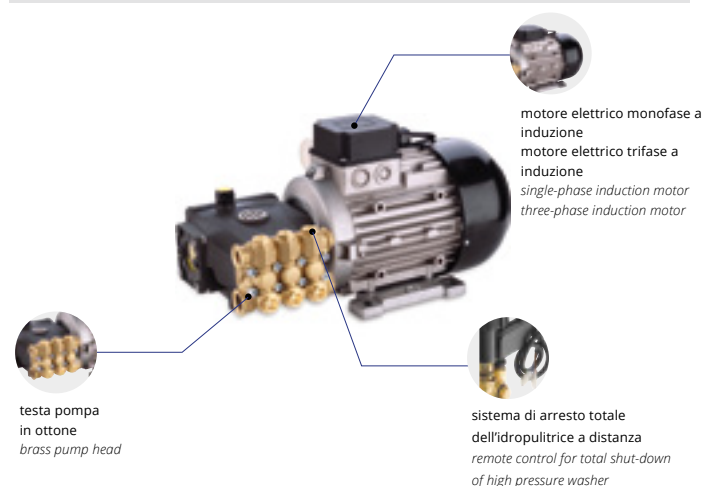

- Pompa a 3 pistoni in ceramica con sistema biella-manovella, testa pompa in ottone
- Valvola di sicurezza automatica con azzeramento della pressione nella testa pompa
- Motore elettrico monofase a induzione con protezione termica
- Motore elettrico trifase a induzione con protezione termica
- Sistema di arresto totale dell'idropulitrice a distanza

- *Triplex pump with ceramic pistons and connecting rod system with brass pump head*
- *Automatic by-pass valve with pump head pressure discharge*
- *Single-phase induction motor with thermal protection*
- *Three-phase induction motor with thermal protection*
- *Remote control for total shut-down of high pressure washer*



HXM

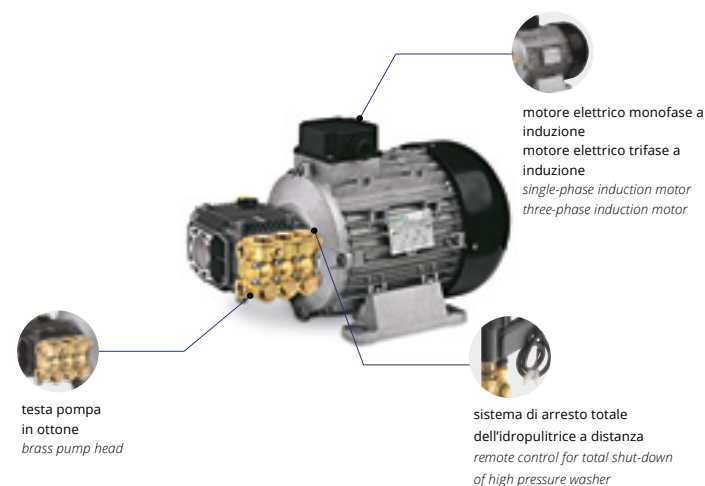

- Pompa a 3 pistoni in ceramica con sistema biella-manovella, testa pompa in ottone
- Valvola di sicurezza automatica con azzeramento della pressione nella testa pompa
- Motore elettrico monofase a induzione con protezione termica
- Motore elettrico trifase a induzione con protezione termica
- Sistema di arresto totale dell'idropulitrice a distanza

- *Triplex pump with ceramic pistons and connecting rod system with brass pump head*
- *Automatic by-pass valve with pump head pressure discharge*
- *Single-phase induction motor with thermal protection*
- *Three-phase induction motor with thermal protection*
- *Remote control for total shut-down of high pressure washer*



HRR

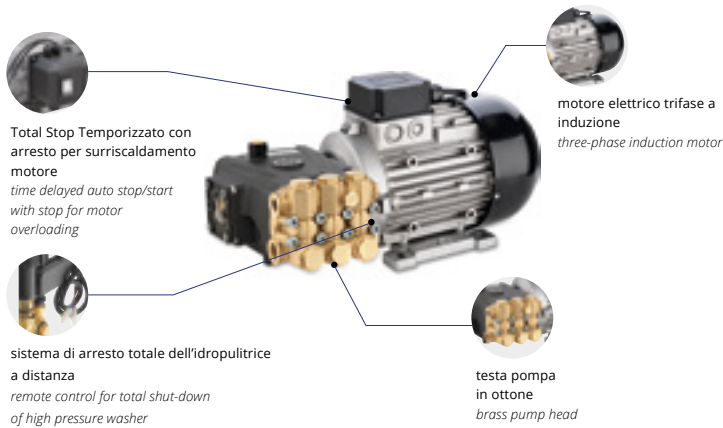

- Pompa a 3 pistoni in ceramica con sistema biella-manovella, testa pompa in ottone
- Valvola di sicurezza automatica con azzeramento della pressione nella testa pompa
- Motore elettrico trifase a induzione con protezione termica
- Sistema di arresto totale dell'idropulitrice a distanza
- Total Stop Temporizzato con arresto per surriscaldamento motore

- Triplex pump with ceramic pistons and connecting rod system with brass pump head
- Automatic by-pass valve with pump head pressure discharge
- Three-phase induction motor with thermal protection
- Remote control for total shut-down of high pressure washer
- Time delayed auto stop/start with stop for motor overloading



HRK

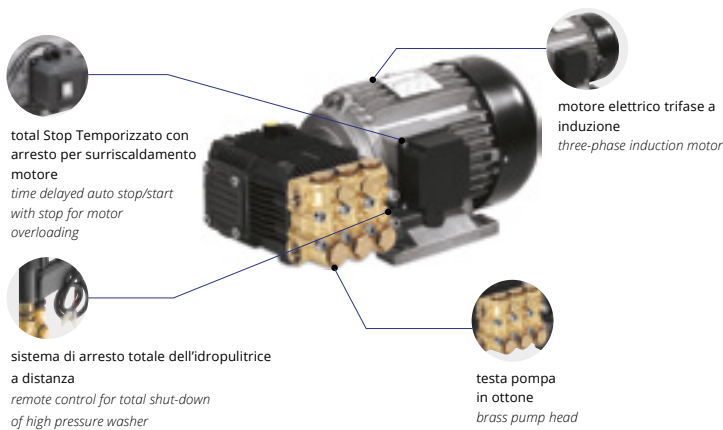

- Pompa a 3 pistoni in ceramica con sistema biella-manovella, testa pompa in ottone
- Valvola di sicurezza automatica con azzeramento della pressione nella testa pompa
- Motore elettrico trifase a induzione con protezione termica
- Sistema di arresto totale dell'idropulitrice a distanza
- Total Stop Temporizzato con arresto per surriscaldamento motore

- Triplex pump with ceramic pistons and connecting rod system with brass pump head
- Automatic by-pass valve with pump head pressure discharge
- Three-phase induction motor with thermal protection
- Remote control for total shut-down of high pressure washer
- Time delayed auto stop/start with stop for motor overloading

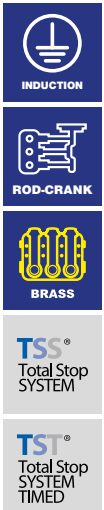

HRW

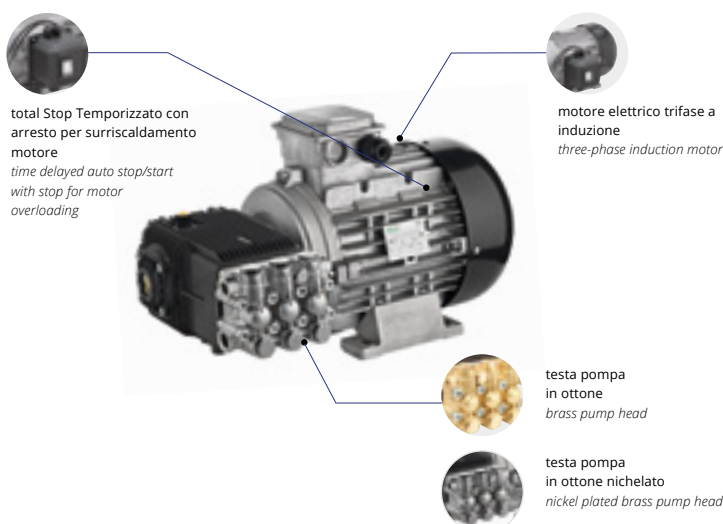

- Pompa a 3 pistoni in ceramica con sistema biella-manovella, testa pompa in ottone
- Valvola di sicurezza automatica con azzeramento della pressione nella testa pompa
- Motore elettrico trifase a induzione con protezione termica
- Total Stop Temporizzato con arresto per surriscaldamento motore

- Triplex pump with ceramic pistons and connecting rod system with brass pump head
- Automatic by-pass valve with pump head pressure discharge
- Three-phase induction motor with thermal protection
- Time delayed auto stop/start with stop for motor overloading



HRG

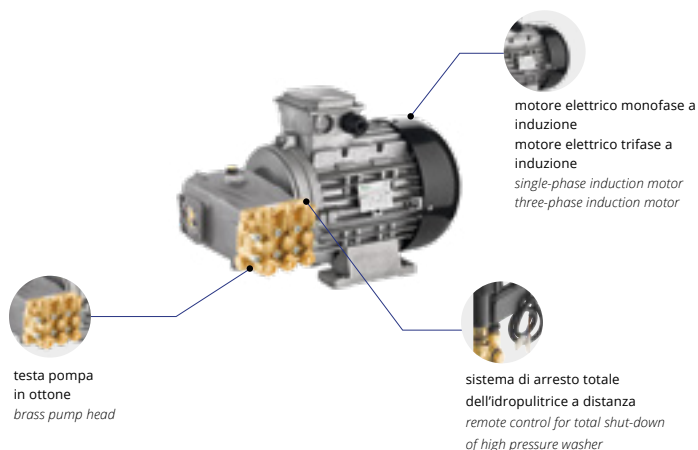

- Pompa a 3 pistoni in ceramica con sistema biella-manovella, testa pompa in ottone
- Valvola di sicurezza automatica con azzeramento della pressione nella testa pompa
- Motore elettrico trifase a induzione con protezione termica
- Sistema di arresto totale dell'idropulitrice a distanza

- Triplex pump with ceramic pistons and connecting rod system with brass pump head
- Automatic by-pass valve with pump head pressure discharge
- Three-phase induction motor with thermal protection
- Remote control for total shut-down of high pressure washer



HXW

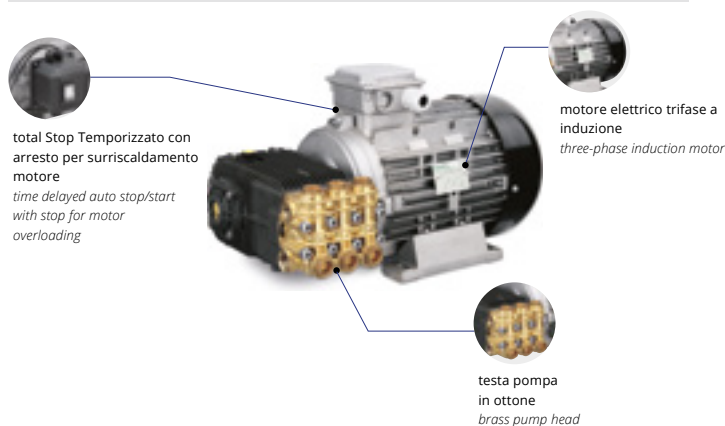

- Pompa a 3 pistoni in ceramica con sistema biella-manovella, testa pompa in ottone
- Valvola di sicurezza automatica con azzeramento della pressione nella testa pompa
- Motore elettrico trifase a induzione con protezione termica
- Total Stop Temporizzato con arresto per surriscaldamento motore

- Triplex pump with ceramic pistons and connecting rod system with brass pump head
- Automatic by-pass valve with pump head pressure discharge
- Three-phase induction motor with thermal protection
- Time delayed auto stop/start with stop for motor overloading



HSXW



- Pompa a 3 pistoni in ceramica con sistema biella-manovella, testa pompa in ottone
- Valvola di sicurezza automatica con azzeramento della pressione nella testa pompa
- Motore elettrico trifase a induzione con protezione termica
- Total Stop Temporizzato con arresto per surriscaldamento motore

- Triplex pump with ceramic pistons and connecting rod system with brass pump head
- Automatic by-pass valve with pump head pressure discharge
- Three-phase induction motor with thermal protection
- Time delayed auto stop/start with stop for motor overloading



HSHP



- Pompa a 3 pistoni in ceramica con sistema biella-manovella, testa pompa in ottone
- Valvola di sicurezza automatica con azzeramento della pressione nella testa pompa
- Motore elettrico trifase a induzione con protezione termica

- Triplex pump with ceramic pistons and connecting rod system with brass pump head
- Automatic by-pass valve with pump head pressure discharge
- Three-phase induction motor with thermal protection





RPV



testa pompa in alluminio
aluminum pump head

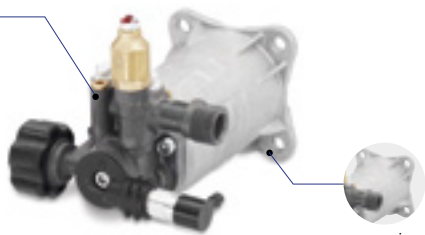

accoppiamento diretto pompa/motore a scoppio
direct coupling pump with gasoline motor drive



- Pompa a 3 pistoni assiali comandati dal piattello oscillante, testa alluminio
 - Pistoni in acciaio inox temperato
 - Valvola di sicurezza automatica con azzeramento della pressione nella testa pompa
 - Accoppiamento diretto pompa/motore a scoppio
- *3 Axial stainless steel pistons wobble-plate pump with aluminum head*
 - *Tempered stainless steel pistons*
 - *Automatic by-pass valve with pump head pressure discharge*
 - *Direct coupling pump with gasoline motor*



RMW



testa pompa in alluminio
aluminum pump head

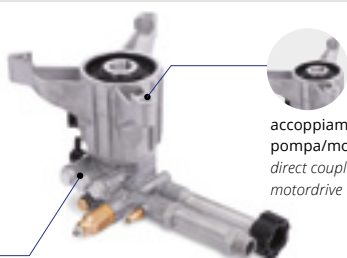

accoppiamento diretto pompa/motore a scoppio
direct coupling pump with gasoline motor drive



- Pompa a 3 pistoni assiali comandati dal piattello oscillante, testa alluminio
 - Pistoni in acciaio inox temperato
 - Valvola di sicurezza automatica con azzeramento della pressione nella testa pompa
 - Accoppiamento diretto pompa/motore a scoppio
- *3 Axial stainless steel pistons wobble-plate pump with aluminum head*
 - *Tempered stainless steel pistons*
 - *Automatic by-pass valve with pump head pressure discharge*
 - *Direct coupling pump with gasoline motor*



RMV



testa pompa in ottone
brass pump head

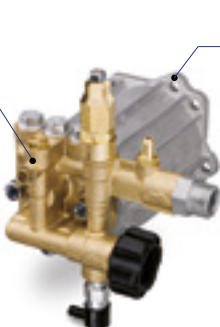

accoppiamento diretto pompa/motore a scoppio
direct coupling pump with gasoline motor drive



- Pompa a 3 pistoni assiali comandati dal piattello oscillante, testa ottone
 - Pistoni in acciaio inox temperato
 - Valvola di sicurezza automatica con azzeramento della pressione nella testa pompa
 - Accoppiamento diretto pompa/motore a scoppio
- *3 Axial stainless steel pistons wobble-plate pump with brass head*
 - *Tempered stainless steel pistons*
 - *Automatic by-pass valve with pump head pressure discharge*
 - *Direct coupling pump with gasoline motor*



SRMV



testa pompa in alluminio
aluminum pump head

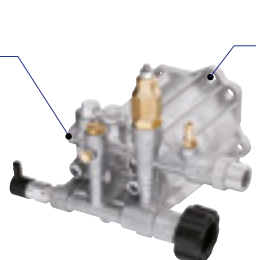

accoppiamento diretto pompa/motore a scoppio
direct coupling pump with gasoline motor drive



- Pompa a 3 pistoni assiali comandati dal piattello oscillante, testa alluminio
 - Pistoni in acciaio inox temperato
 - Valvola di sicurezza automatica con azzeramento della pressione nella testa pompa
 - Accoppiamento diretto pompa/motore a scoppio
- *3 Axial stainless steel pistons wobble-plate pump with aluminum head*
 - *Tempered stainless steel pistons*
 - *Automatic by-pass valve with pump head pressure discharge*
 - *Direct coupling pump with gasoline motor*



RCV



testa pompa in ottone
brass pump head



accoppiamento diretto
pompa/motore a scoppio
direct coupling pump with
gasoline motordrive



- Pompa a 3 pistoni assiali comandati dal piattello oscillante, testa ottone
- Pistoni in acciaio inox temperato
- Valvola di sicurezza automatica con azzeramento della pressione nella testa pompa
- Accoppiamento diretto pompa/motore a scoppio

- *3 Axial stainless steel pistons wobble-plate pump with brass head*
- *Tempered stainless steel pistons*
- *Automatic by-pass valve with pump head pressure discharge*
- *Direct coupling pump with gasoline motor*



RRV



testa pompa in ottone
brass pump head



accoppiamento diretto
pompa/motore a scoppio
direct coupling pump with gasoline
motordrive



- Pompa a 3 pistoni assiali comandati dal piattello oscillante, testa ottone
- Pistoni in acciaio inox temperato
- Valvola di sicurezza automatica con azzeramento della pressione nella testa pompa
- Accoppiamento diretto pompa/motore a scoppio

- *3 Axial stainless steel pistons wobble-plate pump with brass head*
- *Tempered stainless steel pistons*
- *Automatic by-pass valve with pump head pressure discharge*
- *Direct coupling pump with gasoline motor*

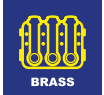

RKA+CR



testa pompa in
ottone nichelato
nichel plated brass pump
head



accoppiamento pompa/motore
a scoppio con riduttore di giri
coupling pump/gasoline motor by
gear box drive



- Pompa a 3 pistoni assiali comandati dal piattello oscillante, testa ottone nichelato
- Pistoni in acciaio inox temperato
- Valvola di sicurezza automatica con azzeramento della pressione nella testa pompa
- Accoppiamento pompa/motore a scoppio con riduttore di giri

- *3 Axial stainless steel pistons wobble-plate pump with nichel plated brass head*
- *Tempered stainless steel pistons*
- *Automatic by-pass valve with pump head pressure discharge*
- *Coupling pump/gasoline motor by gear box drive*





POMPE / PUMPS



	HRM	HPZ	HPV	HPV-O	HPE	HJRS-O	HRS	HRC	HXM	HRR	HRK	HRW
610			●									
613				●								
614				●								
615				●								
625					●							
630					●							
650					●							
613K				●								
614K				●								
615K				●								
630K				●								
670						●						
671						●						
672						●						
737		●										
747		●										
767					●							
780							●					
787							●					
797							●					
930								●				
940									●			
950								●				
970										●		
990											●	
1000K	●											
1001K				●								
1003K								●				
1004K								●				
1001				●								
1003								●				
1004								●				
1007										●		
1008											●	
1010N										●		
1015N										●		
1018												●
1018H												●
1120												
1125												
1130												
1230												
1240												
1250S								●				
1255S									●			
1260S										●		
1270S											●	
1280S												●
1290S												●
1415												●
1425												
1440												
1435												
1450												
1445												
1460												
1480												
1475												
1490												
1492												

SERIE - SERIES

POMPE / PUMPS



HXW	HSXW	HSHP	HRG	RPV	RMW	RMV	SRMV	RCV	RRV	RKA+CR	
											610
											613
											614
											615
											625
											630
											650
											613K
											614K
											615K
											630K
											670
											671
											672
											737
											747
											767
											780
											787
											797
											930
											940
											950
											970
											990
											1000K
											1001K
											1003K
											1004K
											1001
											1003
											1004
											1007
											1008
											1010N
											1015N
											1018
											1018H
●											1120
●											1125
	●										1130
		●									1230
●											1240
●											1250S
											1255
											1260S
											1270
			●								1280S
											1290S
				●							1415
					●						1425
						●					1440
							●				1435
								●			1450
						●					1445
									●		1460
									●		1480
									●		1475
										●	1490
										●	1492

SERIE - SERIES





SERIE 6	P 66
SERIE 7	P 74
SERIE 9	P 78
SERIE 10	P 84
SERIE 11	P 93
SERIE 12	P 96
SERIE 14	P 100







6 Series 610

IDROPULTRICI ALTA PRESSIONE
high pressure washers

OLIGHTPRO

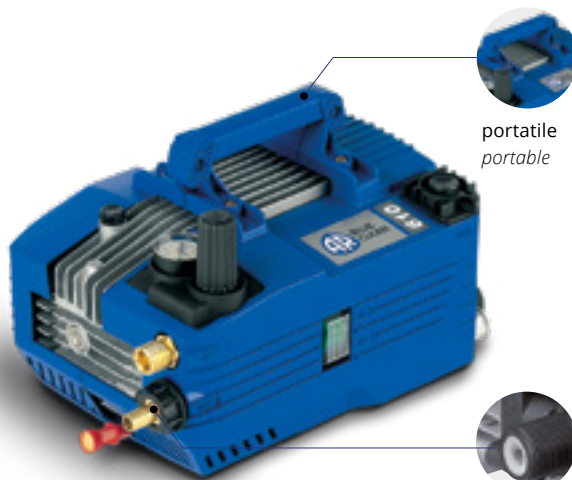

portatile
portable

filtro ingresso acqua
ispezionabile
inspectable water
intake filter

Caratteristiche Generali

- Pompa a 3 pistoni in ceramica con sistema biella-manovella
- Valvola di sicurezza automatica con azzeramento della pressione nella testa pompa
- Motore elettrico monofase a induzione con protezione termica
- Regolazione della pressione
- Manometro
- Aspirazione detergente incorporata
- Serbatoio detergente incorporato
- Lunghezza cavo elettrico 5 m

General Features

- Triplex pump with ceramic pistons and connecting rod system
- Automatic by-pass valve with pump head
- pressure discharge
- Single-phase induction motor with thermal protection
- Pressure adjustment
- Pressure gauge
- Built-in detergent suction
- Built-in detergent tank
- Electric cable length 5 m



MOD	COD	MAX	MAX		NET					
		bar	psi	l/h	gph	kW	rpm	Hz	V	kg
610	12358	130	1900	500	132	2,2	2800	50	230~	17,5



Accessori standard Standard accessories

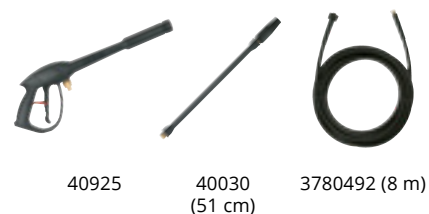

OLIGHTPRO



portatile
portable

filtro ingresso acqua
ispezionabile
inspectable water
intake filter

Caratteristiche Generali

- Pompa a 3 pistoni in ceramica con sistema biella-manovella
- Valvola di sicurezza automatica con azzeramento della pressione nella testa pompa
- Motore elettrico monofase a induzione con protezione termica
- Regolazione della pressione
- Manometro
- Aspirazione detergente incorporata
- Lunghezza cavo elettrico 5 m

General Features

- Triplex pump with ceramic pistons and connecting rod system
- Automatic by-pass valve with pump head pressure discharge
- Single-phase induction motor with thermal protection
- Pressure adjustment
- Pressure gauge
- Built-in detergent suction
- Electric cable length 5 m



MOD	COD									
		MAX	MAX		NET					
		bar	psi	l/h	gph	kW	rpm	Hz	V	kg
613	13975	150	2200	500	132	2,5	2800	50	220-240~	16,8
614	13977	160	2300	510	135	2,9	2800	50	220-240~	18,4
615	14058	130	1900	630	166	2,9	2800	50	220-240~	18,4

° A richiesta / On request



OPTIONAL / OPZIONALE Cod. 43972	OPTIONAL / OPZIONALE Cod. 41738	OPTIONAL / OPZIONALE Cod. 41739	OPTIONAL / OPZIONALE Cod. 41880
 Orientable holder ø 25cm	 Hose reel kit trolley version	 Wall mounted kit without hose	 Wall mounted kit with 15m hose

Accessori standard Standard accessories



40925	41269 (613 - 49 cm)	3780491 (8 m)
	41806 (614 - 49 cm)	
	41747 (615 - 49 cm)	



6K Series 613K.614K.615K

IDROPULTRICI ALTA PRESSIONE
high pressure washers



OLIGHTPRO

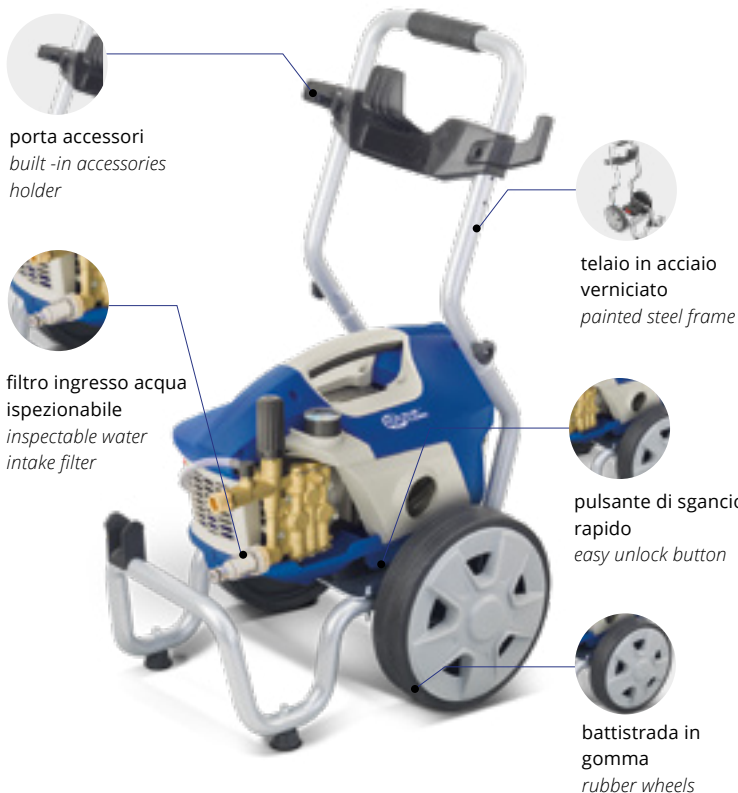

Caratteristiche Generali

- Carrello a 2 ruote completo di manico
- Pompa a 3 pistoni in ceramica con sistema biella-manovella
- Valvola di sicurezza automatica con azzeramento della pressione nella testa pompa
- Motore elettrico monofase a induzione con protezione termica
- Regolazione della pressione
- Manometro
- Aspirazione detergente incorporata
- Lunghezza cavo elettrico 5 m

General Features

- Two-wheel trolley with handle
- Triplex pump with ceramic pistons and connecting rod system
- Automatic by-pass valve with pump head
- pressure discharge
- Single-phase induction motor with thermal protection
- Pressure adjustment
- Pressure gauge
- Built-in detergent suction
- Electric cable length 5 m



MOD	COD	MAX		MAX							KG NET
		bar	psi	l/h	gph	kW	rpm	Hz	V	kg	
613K	13976	150	2200	500	132	2,5	2800	50	220-240~	23	
614K °	13978	160	2300	510	135	2,9	2800	50	220-240~	24,6	
615K °	14059	130	1900	630	166	2,9	2800	50	220-240~	24,6	

° A richiesta / On request



Accessori standard Standard accessories



40925 41269 3780441 (10 m)
 (613K - 49 cm)
 41806
 (614K - 49 cm)
 41747
 (615K - 49 cm)

WALL MOUNTED & KART UNIT

- 1** UNITÀ DI MONTAGGIO A MURO
Wall mounted kit
- 2** KIT AVVOLGITUBO A MURO
Wall mounted hose reel
- 3** TUBO AD ALTA PRESSIONE DI 15M
HP 15mt hose.
- 4** PULSANTE DI SGANCIO RAPIDO
Easy unlock button
- 5** RUOTE AD ALTA STABILITÀ
High stability wheels
- 6** KIT CARRELLO CON TELAIO
PIEGHEVOLE IN ACCIAIO VERNICIATO
Trolley kit with foldable painted steel frame
- 7** PORTA ACCESSORI INTEGRATO
Built-in accessory holder



UNITÀ DI MONTAGGIO A MURO

AR COD. 41880

EAN COD. 8016287418805

Kit avvolgitubo a muro con tubo ad alta pressione di 15m.

WALL MOUNTED UNIT

Wall mounted hose reel with HP hose 15m hose.

KIT CARRELLO

AR COD. 41869

EAN COD. 8016287418690

Telaio pieghevole in acciaio verniciato con grandi ruote durature di ø250mm per un migliore bilanciamento.

TROLLEY KIT

Foldable painted steel frame with durable rubber wheels ø250mm for perfect balancing.



6 Series 625.630.650

IDROPULTRICI ALTA PRESSIONE
high pressure washers

OLIGHTPRO



portatile
portable

filtro ingresso acqua
ispezionabile
inspectable water
intake filter

Caratteristiche Generali

- Pompa a 3 pistoni in ceramica con sistema biella-manovella
- Valvola di sicurezza automatica con azzeramento della pressione nella testa pompa
- Motore elettrico monofase a induzione con protezione termica
- Regolazione della pressione
- Manometro
- Aspirazione detergente incorporata
- Lunghezza cavo elettrico 5 m

General Features

- Triplex pump with ceramic pistons and connecting rod system
- Automatic by-pass valve with pump head
- pressure discharge
- Single-phase induction motor with thermal protection
- Pressure adjustment
- Pressure gauge
- Built-in detergent suction
- Electric cable length 5 m

INDUCTION

ROD-CRANK

HPE

625 ALUMINUM

630.650 BRASS

MAX 60°C 140°F

IPX5-S1

MOD	COD	MAX		MAX						KG NET
		bar	psi	l/h	gph	kW	rpm	Hz	V	kg
625	13711	120	1740	600	159	2,6	2800	50	230~	20
630	12360	120	1740	600	159	2,6	1450	50	230~	27
650	12455	150	2200	480	127	3,0	2800	50	230~	27

Accessori standard Standard accessories



OPTIONAL / OPZIONALE
Cod. 43972

Carrello con
manico orientabile
Orientable holder

ø 25cm

OPTIONAL / OPZIONALE
Cod. 41738

Kit avvolgitubo per carrello
Hose reel kit trolley version



OLIGHTPRO



porta accessori
built-in accessories
holder

telaio in acciaio
verniciato
painted steel frame

pulsante di sgancio
rapido
easy unlock button

battistrada in
gomma
rubber wheels



Caratteristiche Generali

- Carrello a 2 ruote completo di manico
- Pompa a 3 pistoni in ceramica con sistema biella-manovella
- Valvola di sicurezza automatica con azzeramento della pressione nella testa pompa
- Motore elettrico monofase a induzione con protezione termica
- Regolazione della pressione
- Aspirazione detergente incorporata
- Lunghezza cavo elettrico 5 m

General Features

- Two-wheel trolley with handle
- Triplex pump with ceramic pistons and connecting rod system
- Automatic by-pass valve with pump head
- pressure discharge
- Single-phase induction motor with thermal protection
- Pressure adjustment
- Built-in detergent suction
- Electric cable length 5 m

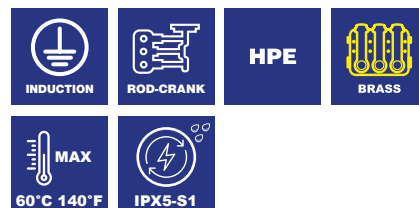

MOD	COD	MAX		MAX					KG NET	
		bar	psi	l/h	gph	kW	rpm	Hz	V	kg
630K	14633	120	1740	600	159	2,6	1450	50	230~	34,5



Accessori standard Standard accessories



40925

46056
(49 cm)

1271351 (10 m)

OPTIONAL / OPZIONALE
Cod. 41738

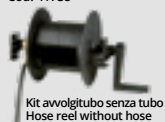

Kit avvolgitubo senza tubo
Hose reel without hose

OPTIONAL / OPZIONALE
Cod. 41739



Unità di montaggio a muro
senza tubo
Wall mounted kit without hose

OPTIONAL / OPZIONALE
Cod. 41880



Unità di montaggio a muro
con tubo 15m
Wall mounted kit with
15m hose



6 Series 670.671.672

IDROPULTRICI ALTA PRESSIONE
high pressure washers

OLIGHTPRO



Caratteristiche Generali

- Pompa a 3 pistoni in ceramica con sistema biella-manovella
- Valvola di sicurezza automatica con azzeramento della pressione nella testa pompa
- Motore elettrico monofase a induzione con protezione termica
- Regolazione della pressione
- Manometro
- Aspirazione detergente incorporata
- Lunghezza cavo elettrico 5m

General Features

- Triplex pump with ceramic pistons and connecting rod system
- Automatic by-pass valve with pump head pressure discharge
- Single-phase induction motor with thermal protection
- Pressure adjustment
- Pressure gauge
- Built-in detergent suction
- Electric cable length 5m



MOD	COD	MAX		MAX						KG NET
		bar	psi	l/h	gph	kW	rpm	Hz	V	kg
670	14680	160	2300	500	132	2,5	2800	50	220-240~	20
671	14697	180	2600	510	135	2,9	2800	50	220-240~	23,6
672	14681	150	2200	630	166	2,9	2800	50	220-240~	23,6

Accessori standard Standard accessories



40925

43954
(670 - 47 cm)
43955
(671 - 47 cm)
43956
(672 - 47 cm)

3780491 (8 m)



OPTIONAL / OPZIONALE
Cod. 43972

Carrello con
manico orientabile
Orientable holder

ø 25cm

OPTIONAL / OPZIONALE
Cod. 41738

Kit avvolgitubo per carrello
Hose reel kit trolley version





7 Series 737.747

IDROPULTRICI ALTA PRESSIONE
high pressure washers

OLIGHTPRO



manico ergonomico
ergonomic handle

porta accessori
built-in accessories
holder

serbatoio detergente
integrato
built-in detergent
tank

battistrada in
gomma
rubber wheels

filtro ingresso acqua
ispezionabile
inspectable water
intake filter

Caratteristiche Generali

- Carrello a due ruote completo di manico
- Pompa a 3 pistoni assiali comandati dal piattello oscillante
- Pistoni in acciaio inox temperato
- Valvola di sicurezza automatica con azzeramento della pressione nella testa pompa
- Motore elettrico monofase a induzione con protezione termica
- Regolazione della pressione
- Manometro
- Aspirazione detergente incorporata
- Aspirazione detergente regolabile
- Capacità del serbatoio detergente 2l
- Lunghezza cavo elettrico 5m

General Features

- Two-wheel trolley with handle
- 3 Axial-piston wobble-plate pump
- Tempered stainless steel pistons
- Automatic by-pass valve with pump head pressure discharge
- Single phase induction motor with thermal protection
- Pressure adjustment
- Pressure gauge
- Built-in detergent suction
- Adjustable detergent injector
- Detergent tank capacity 2l
- Electric cable length 5m

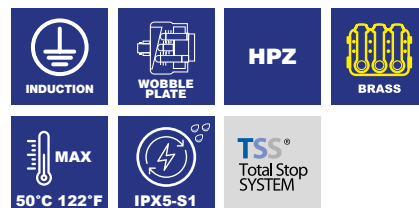

MOD	COD	MAX		MAX						KG NET
		bar	psi	l/h	gph	kW	rpm	Hz	V	
737	12361	150	2200	480	127	2,7	2800	50	230~	27
747	12362	160	2300	540	142	3,1	2800	50	230~	29



Accessori standard Standard accessories



40925 41553 (737 - 49 cm)
40751 (747 - 49 cm)

1271960 (10 m)

OLIGHTPRO



Caratteristiche Generali

- Carrello a due ruote completo di manico
- Pompa a 3 pistoni in ceramica,
- con sistema biella-manovella
- Valvola di sicurezza automatica con azzeramento della pressione nella testa pompa
- Motore elettrico monofase a induzione con protezione termica
- Regolazione della pressione
- Manometro
- Aspirazione detergente incorporata
- Aspirazione detergente regolabile
- Capacità del serbatoio detergente 2l
- Lunghezza cavo elettrico 5m

General Features

- Two-wheel trolley unit with handle
- Triples pump with ceramic pistons and connecting rod system
- Automatic safety valve with pressure shut-off at pump head
- Single-phase induction motor with thermal protection
- Pressure adjustment
- Pressure gauge
- Built-in detergent suction
- Adjustable detergent injector
- Detergent tank capacity 2l
- Electric cable length 5m



MOD	COD	MAX		MAX					KG NET	
		bar	psi	l/h	gph	kW	rpm	Hz	V	kg
767	12364	130	1900	600	159	2,6	1450	50	230~	35

Accessori standard Standard accessories





7 Series 780.787.797

IDROPULTRICI ALTA PRESSIONE
high pressure washers

HEAVYPRO



manico ergonomico
ergonomic handle

porta accessori
built-in accessories
holder

serbatoio detergente
integrato
built-in detergent
tank

battistrada in
gomma
rubber wheels

filtro ingresso acqua
ispezionabile
inspectable water
intake filter

Caratteristiche Generali

- Carrello a due ruote completo di manico
- Pompa a 3 pistoni in ceramica, con sistema biella-manovella
- Valvola di sicurezza automatica con azzeramento della pressione nella testa pompa
- Motore elettrico trifase con protezione termica (monofase mod. 780)
- Regolazione della pressione
- Manometro
- Aspirazione detergente incorporata
- Aspirazione detergente regolabile
- Capacità del serbatoio detergente 2l
- Lunghezza cavo elettrico 5m

General Features

- Two-wheel trolley with handle
- Triplex pump with ceramic pistons and connecting rod system
- Automatic safety valve with pressure shut-off at pump head
- Three-phase heavy duty motor with thermal protector (single-phase for 780 model)
- Pressure adjustment
- Pressure gauge
- Built-in detergent suction
- Adjustable detergent injector
- Detergent tank capacity 2l
- Power supply cable length 5m



TSS®
Total Stop
SYSTEM



MOD	COD	MAX		MAX							KG NET
		bar	psi	l/h	gph	kW	rpm	Hz	V	kg	
780	22341	130	1900	720	190	3,1	1450	50	230~	41,5	
787 [°]	22320	150	2200	900	238	5	1450	50	400 3~	43	
797 [°]	22321	180	2600	770	203	5	1450	50	400 3~	43	
780 RLW [‡]	22429	130	1900	720	190	3,1	1450	50	230~	44	
787 RLW [‡]	22430	150	2200	900	238	5	1450	50	400 3~	47	
797 RLW [‡]	22431	180	2600	770	203	5	1450	50	400 3~	47	

Accessori standard Standard accessories



41046 40713 1271960 (10 m)
 (780 - 49 cm)
 41554
 (787 - 49 cm)
 40823
 (797 - 49 cm)

[‡] A richiesta / On request 230 V · 3~50 Hz 1750 rpm

[°] A richiesta / On request





TST[®]
Total Stop
SYSTEM
TIMED



Nata a Modena

Born in Modena

9 SERIES

La nuova Serie 9 è il match perfetto tra design e prestazioni professionali. Nata a Modena, negli stabilimenti dedicati al cleaning, quest'idropultrice ad acqua fredda ha delle dimensioni compatte e vanta un'estrema manovrabilità, che la rendono al tempo stesso robusta e maneggevole. L'impugnatura del manico è stata progettata per facilitarne l'utilizzo, come anche i diversi punti di rimessaggio accessori sulla macchina. Il pratico porta lancia, sul fianco della macchina ed il gancio per il tubo alta pressione nella parte posteriore. Si tratta di una gamma di idropultrici con dotazione completa e professionale, equipaggiate con accessori ideali per utilizzi continuativi e complessi.

9 SERIES

The new Series 9 is the perfect match of design and professional performance. Created in Modena, in the plants that specialise in cleaning equipment, this cold water high pressure washer is compact in size and very manoeuvrable, making it both sturdy and agile. The handle grip is styled for user-friendliness, as are the various accessory stowing points on the appliance. These include the handy lance holder on the side of the appliance and the high pressure hose hook at the rear. It is a high pressure washer range with a full, professional outfit, equipped with the ideal accessories for continuous use on complex jobs.



UNIQUE DETAILS

- 1** MANUBRIO ERGONOMICO
Ergonomic handle
- 2** PORTA ACCESSORI INTEGRATI
Built-in accessories holders
- 3** RUOTE AD ALTA STABILITÀ
High stability wheels ø 35 cm
- 4** PRESSIONE REGOLABILE
Pressure adjustment
- 5** MANOMETRO
Pressure gauge
- 6** FILTRO ACQUA ISPEZIONALE
Inspectable water filter



THE POWER OF CLEANING

Grazie all'elevata pressione ed alle notevoli portate, le idropultrici della SERIE 9, riescono a rimuovere con estrema facilità lo sporco più ostinato ed incrostato dalle grandi superfici. Le prestazioni di queste idropultrici sono state studiate per soddisfare al meglio questo genere di esigenze, specialmente nel settore edile ed automotive.

THE POWER OF CLEANING

Thanks to their high pressures and flow rates, SERIES 9 high pressure washers can remove the most stubborn, firmly encrusted dirt from large surfaces. These high pressure washers have performance levels designed to tackle needs of this kind with the greatest success, especially in the construction and automotive sectors.

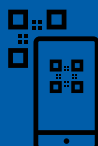



9SERIES





HEAVYPRO



Caratteristiche Generali

- Carrello a due ruote completo di manico
- Pompa a 3 pistoni in ceramica, con sistema biella-manovella
- Valvola di sicurezza automatica con azzeramento della pressione nella testa pompa
- Motore elettrico monofase a induzione con protezione termica
- Regolazione della pressione
- Manometro
- Aspirazione detergente incorporata
- Aspirazione detergente regolabile
- Lunghezza cavo elettrico 5 m

General Features

- Two-wheel trolley unit with handle
- Triplex pump with ceramic pistons and connecting rod system
- Automatic safety valve with pressure shut-off at pump head
- Single-phase induction motor with thermal protection
- Pressure adjustment
- Pressure gauge
- Built-in detergent suction
- Adjustable detergent injector
- Electric cable length 5 m

930.950	940	970	990
HRC	HXM	HRR	HRK

INDUCTION	ROD-CRANK	BRASS	970.990
MAX 60°C 140°F	IPX5-S1	TSS® Total Stop SYSTEM	TST® Total Stop SYSTEM TIMED

MOD	COD	MAX		MAX						KG NET
		bar	psi	l/h	gph	kW	rpm	Hz	V	
930	14261	150	2200	630	166	3	1450	50	230~	43,6
940	14503	150	2200	900	238	5	1450	50	400 3~	48,2
950	14262	150	2200	900	238	5	1450	50	400 3~	45,5
970	14504	200	2900	900	238	7,4	1450	50	400 3~	52,2
990	14505	150	2200	1260	333	7,4	1450	50	400 3~	56,8

° A richiesta / On request 230 V · 3~50 Hz 1750 rpm



Accessori standard Standard accessories









10 Series 1000K

IDROPULTRICI ALTA PRESSIONE
high pressure washers

OLIGHTPRO



Caratteristiche Generali

- Carrello robusto in metallo a due ruote completo di manico
- Pompa a 3 pistoni assiali comandati dal piattello oscillante
- Valvola di by-pass automatica con azzeramento della pressione nella testa della pompa
- Motore elettrico a induzione monofase con protezione termica
- Aspirazione detergente
- Filtro acqua ispezionabile
- Lunghezza cavo elettrico 5 m

General Features

- Heavy-duty two wheeled trolley with handle
- 3 Axial stainless steel pistons wobble-plate pump
- Automatic by-pass valve with pressure with pump head pressure discharge
- Single-phase induction motor with thermal protector
- Detergent suction
- Inspectable water filter
- Electric cable length 5 m



MOD	COD	MAX		MAX					KG NET	
		bar	psi	l/h	gph	kW	rpm	Hz	V	kg
1000 K	25541	150	2200	480	127	2,6	2800	50	230~	21,8

Accessori standard Standard accessories





OLIGHTPRO



Caratteristiche Generali

- Carrello robusto in metallo a due ruote completo di manico
- Pompa a pistoni con sistema biella-manovella ad elevate prestazioni
- Valvola di by-pass automatica con azzeramento della pressione nella testa della pompa
- Motore elettrico a induzione monofase con protezione termica
- Regolazione della pressione
- Manometro
- Aspirazione detergente
- Filtro acqua ispezionabile
- Lunghezza cavo elettrico 5 m

General Features

- Heavy-duty two wheeled trolley with handle
- High performance piston pump with connecting rod system
- Automatic by-pass valve with pressure with pump head pressure discharge
- Single-phase induction motor with thermal protector
- Pressure adjustment
- Pressure gauge
- Detergent suction
- Inspectable water filter
- Electric cable length 5 m



MOD	COD	MAX		MAX					KG NET	
		bar	psi	l/h	gph	kW	rpm	Hz	V	kg
1001 K	25542	150	2200	500	132	2,5	2800	50	230~	22

Accessori standard Standard accessories





10 Series 1003K.1004K

IDROPULTRICI ALTA PRESSIONE
high pressure washers

HEAVYPRO



telaio in acciaio verniciato
painted steel frame

porta accessori
built-in accessories holder

filtro ingresso acqua ispezionabile
inspectable water intake filter

battistrada in gomma
rubber wheels

filtro detergente
detergent filter

Caratteristiche Generali

- Carrello robusto in metallo a due ruote completo di manico
- Pompa a pistoni con sistema biella-manovella ad elevate prestazioni
- Valvola di by-pass automatica con azzeramento della pressione nella testa della pompa
- Motore elettrico a induzione monofase con protezione termica (mod. 1003 K)
- Motore elettrico a induzione trifase con protezione termica (mod. 1004 K)
- Regolazione della pressione
- Manometro
- Aspirazione detergente
- Filtro acqua ispezionabile
- Lunghezza cavo elettrico 5 m

General Features

- Heavy-duty two wheeled trolley with handle
- High performance piston pump with connecting rod system
- Automatic by-pass valve with pressure with pump head pressure discharge
- Single-phase induction motor with thermal protector (mod. 1003 K)
- Three-phase induction motor with thermal protector (mod. 1004 K)
- Pressure adjustment
- Pressure gauge
- Detergent suction
- Inspectable water filter
- Electric cable length 5 m



MOD	COD	MAX		MAX						KG NET
		bar	psi	l/h	gph	kW	rpm	Hz	V	
1003K	25543	150	2200	630	166	3	1450	50	230~	35,6
1004K	25544	150	2200	900	238	5	1450	50	400 3~	37,6

◊ A richiesta / On request 230 V 3~ 50 Hz 1750 rpm



Accessori standard Standard accessories

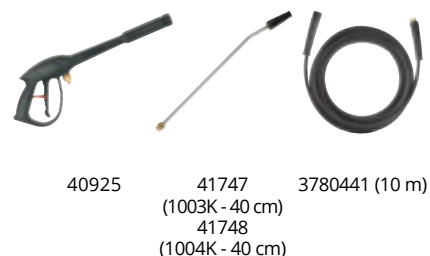

40925 41747 3780441 (10 m)
 (1003K - 40 cm)
 41748
 (1004K - 40 cm)



OLIGHTPRO



Caratteristiche Generali

- Carrello robusto in metallo a due ruote completo di manico
- Pompa a 3 pistoni in ceramica, con sistema biella-manovella
- Valvola di by-pass automatica con azzeramento della pressione nella testa della pompa
- Motore elettrico a induzione monofase con protezione termica
- Regolazione della pressione
- Manometro
- Aspirazione detergente incorporata
- Aspirazione detergente regolabile
- Capacità del serbatoio detergente 3 l
- Filtro acqua ispezionabile
- Lunghezza cavo elettrico 5 m

General Features

- Heavy-duty two wheeled trolley with handle
- Triplex pump with ceramic pistons and connecting rod system
- Automatic by-pass valve with pressure with pump head pressure discharge
- Single-phase induction motor with thermal protector
- Pressure adjustment
- Pressure gauge
- Built-in detergent suction
- Adjustable detergent injector
- Built-in detergent tank capacity 3 l
- Inspectable water filter
- Electric cable length 5 m



MOD	COD	MAX		MAX		MAX					KG NET
		bar	psi	l/h	gph	kW	rpm	Hz	V	kg	
1001	24384	150	2200	500	132	2,5	2800	50	230~	26,8	
1001 RLW ^o	24388	150	2200	500	132	2,5	2800	50	230~	33,2	

^o A richiesta / On request



RLW

Versione RLW a richiesta
RLW Version on request
15m



Accessori standard Standard accessories



40925 3600650 3780441 (10 m)
(49 cm)



3600400 (low pressure) Nero/Black
3600440 (0003) Rosso/Red
3600450 (1503) Giallo/Yellow
3600460 (2503) Verde/Green
3600470 (4003) Bianco/White



10 Series 1003.1004

IDROPULTRICI ALTA PRESSIONE
high pressure washers

HEAVYPRO



telaio in acciaio verniciato
painted steel frame



filtro ingresso
acqua ispezionabile
inspectable water
intake filter



porta accessori
built-in accessories holder



serbatoio detergente
integrato
built-in detergent tank



battistrada in
gomma
rubber wheels



Caratteristiche Generali

- Carrello robusto in metallo a due ruote completo di manico
- Pompa a 3 pistoni in ceramica, con sistema biella-manovella
- Valvola di by-pass automatica con azzeramento della pressione nella testa della pompa
- Motore elettrico a induzione monofase con protezione termica
- Regolazione della pressione
- Manometro
- Aspirazione detergente incorporata
- Aspirazione detergente regolabile
- Capacità del serbatoio detergente 3 l
- Filtro acqua ispezionabile
- Lunghezza cavo elettrico 5 m

General Features

- Heavy-duty two wheeled trolley with handle
- Triplex pump with ceramic pistons and connecting rod system
- Automatic by-pass valve with pressure with pump head pressure discharge
- Single-phase induction motor with thermal protector
- Pressure adjustment
- Pressure gauge
- Built-in detergent suction
- Adjustable detergent injector
- Built-in detergent tank capacity 3 l
- Inspectable water filter
- Electric cable length 5 m



MOD	COD	MAX		MAX						KG NET
		bar	psi	l/h	gph	kW	rpm	Hz	V	kg
1003	24385	150	2200	630	166	3	1450	50	230~	49,7
1003RLW ^o	24389	150	2200	630	166	3	1450	50	230~	53
1004 [‡]	25302	150	2200	900	238	5	1450	50	400 3~	51,9
1004RLW ^{±o}	25303	150	2200	900	238	5	1450	50	400 3~	55,2

[‡] A richiesta / On request 230 V · 3~50 Hz 1750 rpm

^o A richiesta / On request



Accessori standard Standard accessories



40925 (1003) 41046 (1004) 3600650 (49 cm)



1271960 (10 m)



1003	1004	
3600400 (low p.)	3600400 (low p.)	Nero/Black
3600350 (0004)	3600720 (0005)	Rosso/Red
3600360 (1504)	3600730 (1505)	Giallo/Yellow
3600370 (2504)	3600740 (2505)	Verde/Green
3600380 (4004)	3600750 (4005)	Bianco/White



HEAVYPRO



telaio in acciaio verniciato
painted steel frame

filtro ingresso
acqua ispezionabile
inspectable water
intake filter

porta accessori
built-in accessories holder

serbatoio detergente
integrato
built-in detergent tank

battistrada in
gomma
rubber wheels

Caratteristiche Generali

- Carrello robusto in metallo a due ruote completo di manico
- Pompa a 3 pistoni in ceramica, con sistema biella-manovella
- Valvola di by-pass automatica con azzeramento della pressione nella testa della pompa
- Motore elettrico a induzione trifase con protezione termica
- Regolazione della pressione
- Manometro
- Valvola di regolazione flangiata (VRZ)
- Aspirazione detergente incorporata
- Aspirazione detergente regolabile
- Capacità del serbatoio detergente 3 l
- Filtro acqua ispezionabile
- Lunghezza cavo elettrico 5 m

General Features

- Heavy-duty two wheeled trolley with handle
- Triplex pump with ceramic pistons and connecting rod system
- Automatic by-pass valve with pressure with pump head pressure discharge
- Three-phase induction motor with thermal protector
- Pressure adjustment
- Flanged pressure unloader (VRZ)
- Built-in detergent suction
- Adjustable detergent injector
- Built-in detergent tank capacity 3 l
- Inspectable water filter
- Electric cable length 5 m

	1007	1008	
	HRR	HRK	
	60°C 140°F		TST® Total Stop SYSTEM TIMED

MOD	COD									
		MAX	MAX		NET					
		bar	psi	l/h	gph	kW	rpm	Hz	V	kg
1007 †	25150	200	2900	900	238	7,4	1450	50	400 3~	54,8
1007RLW‡	25304	200	2900	900	238	7,4	1450	50	400 3~	61,6
1008 †	25305	150	2200	1260	333	7,4	1450	50	400 3~	54,8
1008RLW‡	25306	150	2200	1260	333	7,4	1450	50	400 3~	61,6

† A richiesta / On request 230 V · 3~50 Hz 1750 rpm

‡ A richiesta / On request

Accessori standard Standard accessories

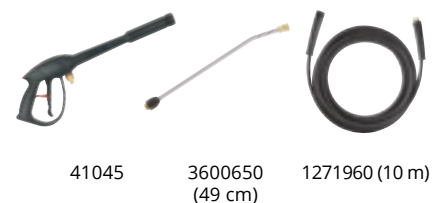

	1007	1008	
	3600400 (low p.)	3600400 (low p.)	Nero/Black
	3600480 (00045)	3600680 (00075)	Rosso/Red
	3600490 (15045)	3600690 (15075)	Giallo/Yellow
	3600500 (25045)	3600700 (25075)	Verde/Green
	3600510 (40045)	3600100 (40075)	Bianco/White





10 Series 1010N.1015N

IDROPULTRICI ALTA PRESSIONE
high pressure washers

HEAVYPRO



Caratteristiche Generali

- Struttura robusta con cofano in acciaio inox
- Pompa a 3 pistoni in ceramica con sistema biella- manovella
- Valvola di by-pass automatica con azzeramento della pressione nella testa della pompa
- Motore elettrico trifase
- Valvola di regolazione flangiata (Gymatic 3/B - ID)
- Regolazione pressione
- Aspirazione detergente incorporata
- Lunghezza cavo elettrico 5 m

General Features

- Heavy-duty frame with stainless steel cover
- Triplex pump with ceramic pistons and connecting rod system
- Automatic by-pass valve with pump head pressure discharge
- Heavy-duty three-phase motor
- Flanged unloader valve (Gymatic 3/B - ID)
- Pressure adjustment
- Built-in detergent suction
- Electric cable length 5 m

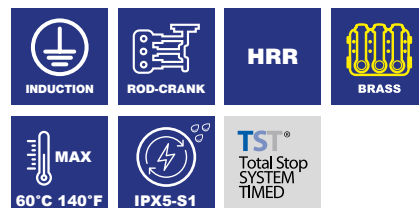

MOD	COD	MAX		MAX							KG NET
		bar	psi	l/h	gph	kW	rpm	Hz	V	kg	
1010N	25282	150	2200	900	238	5	1450	50	400	3~	57
1015N	25283	200	2900	900	238	7,4	1450	50	400	3~	60

Accessori standard Standard accessories



HEAVYPRO



Caratteristiche Generali

- Struttura robusta con cofano in acciaio inox
- Pompa a 3 pistoni in ceramica con sistema biella- manovella
- Valvola di by-pass automatica con azzeramento della pressione nella testa della pompa
- Motore elettrico trifase
- Valvola di regolazione flangiata (Gymatic 3/B - ID)
- Regolazione pressione
- Aspirazione detergente incorporata
- Lunghezza cavo elettrico 5 m

General Features

- Heavy-duty frame with stainless steel cover
- Triplex pump with ceramic pistons and connecting rod system
- Automatic by-pass valve with pump head pressure discharge
- Heavy-duty three-phase motor
- Flanged unloader valve (Gymatic 3/B - ID)
- Pressure adjustment
- Built-in detergent suction
- Electric cable length 5 m

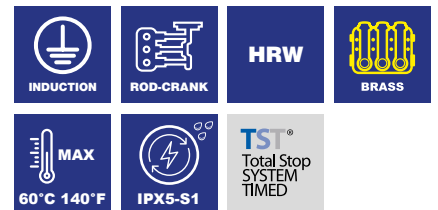

MOD	COD	MAX		MAX						KG NET
		bar	psi	l/h	gph	kW	rpm	Hz	V	kg
1018	24491	200	2900	900	238	7,4	1450	50	400 3~	80



Accessori standard Standard accessories





10 Series 1018H

IDROPULTRICI ALTA PRESSIONE
high pressure washers

HEAVYPRO

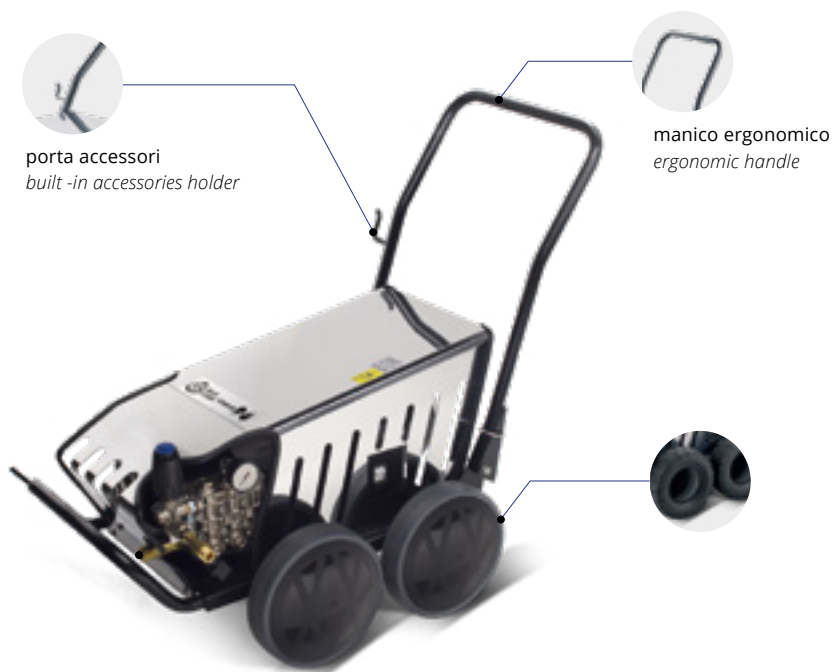

Caratteristiche Generali

- Struttura robusta con cofano in acciaio inox
- Pompa a 3 pistoni in ceramica con sistema biella- manovella
- Guarnizioni in teflon che permettono di utilizzare acqua ad una temperatura massima in ingresso di 85°
- Valvola di by-pass automatica con azzeramento della pressione nella testa della pompa
- Motore elettrico trifase
- Valvola di regolazione flangiata (Gymatic 3/B - ID)
- Regolazione pressione

- Lunghezza cavo elettrico 5 m

General Features

- Heavy-duty frame with stainless steel cover
- Triplex pump with ceramic pistons and connecting rod system
- Teflon gasket to allow cleaning at high temperature. Max inlet water temperature 85°
- Automatic by-pass valve with pump head pressure discharge
- Heavy-duty three-phase motor
- Flanged unloader valve (Gymatic 3/B - ID)
- Pressure adjustment
- Electric cable length 5 m

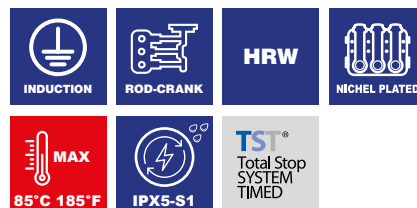

MOD	COD	MAX		MAX					KG NET	
		bar	psi	l/h	gph	kW	rpm	Hz	V	kg
1018H	25272	200	2900	900	238	7,4	1450	50	400 3~	80



Accessori standard Standard accessories



HEAVYPRO



Caratteristiche Generali

- Struttura robusta con cofano in acciaio inox
- Pompa a 3 pistoni in ceramica con sistema biella- manovella
- Testa pompa in ottone
- Valvola di by-pass automatica con azzeramento della pressione nella testa della pompa
- Arresto per microperdite
- Arresto dopo 1 ora di Total Stop
- Arresto per mancanza d'acqua
- Arresto per surriscaldamento motore
- Segnalazione d'errore tramite spia intermittente
- Motore elettrico trifase
- Regolazione pressione
- Aspirazione detergente incorporata
- Lunghezza cavo elettrico 5 m

General Features

- Heavy-duty frame with stainless steel cover
- Triplex pump with ceramic pistons and connecting rod system
- Brass pump head
- Automatic by-pass valve with pump head pressure discharge
- Stop for leak detention
- Stop after 1 hour of total stop
- Stop for lack of water
- Stop for motor overloading
- System error warning light
- Heavy-duty three-phase motor
- Pressure adjustment
- Built-in detergent suction
- Electric cable length 5 m

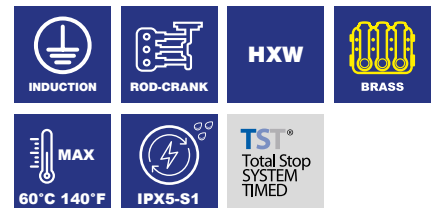

MOD	COD	MAX	MAX							KG NET
		bar	psi	l/h	gph	kW	rpm	Hz	V	kg
1120	22374	200	2900	1260	333	9,3	1450	50	400 3~	110



Accessori standard Standard accessories



HEAVYPRO



Caratteristiche Generali

- Struttura robusta con cofano in acciaio inox
- Pompa a 3 pistoni in ceramica con sistema biella-manovella
- Valvola di by-pass automatica con azzeramento della pressione nella testa della pompa
- Arresto per microperdite
- Arresto dopo 1 ora di Total Stop
- Arresto per mancanza d'acqua
- Arresto per surriscaldamento motore
- Segnalazione d'errore tramite spia intermittente
- Motore elettrico trifase
- Regolazione pressione
- Flangia e giunto elastico
- Avviamento stella-triangolo (AST)
- Lunghezza cavo elettrico 5 m

General Features

- Heavy-duty frame with stainless steel cover
- Triplex pump with ceramic pistons and connecting rod system
- Automatic by-pass valve with pump head pressure discharge
- Stop for leak detention
- Stop after 1 hour of total stop
- Stop for lack of water
- Stop for motor overloading
- System error warning light
- Heavy-duty three-phase motor
- Pressure adjustment
- Flange and flexible coupling
- Star-delta starting (AST)
- Electric cable length 5 m

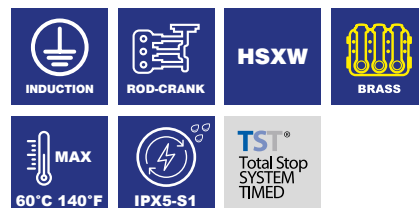

MOD	COD	MAX	MAX							KG NET
		bar	psi	l/h	gph	kW	rpm	Hz	V	kg
1125	22375	350	5100	1260	333	17	1450	50	400 3~	250

Accessori standard Standard accessories



HEAVYPRO



Caratteristiche Generali

- Struttura robusta con cofano in acciaio inox
- Pompa a 3 pistoni in ceramica con sistema biella-manovella
- Valvola di by-pass automatica con azzeramento della pressione nella testa della pompa, solo by-pass
- Motore elettrico trifase
- Regolazione pressione
- Giunto elastico con protezione
- Avviamento stella-triangolo (AST)
- Vaschetta acqua inox
- Lunghezza cavo elettrico 5 m

General Features

- Heavy-duty frame with stainless steel cover
- Triplex pump with ceramic pistons and connecting rod system
- Automatic by-pass valve with pump head pressure discharge, by-pass only
- Heavy-duty three-phase motor
- Pressure adjustment
- Flexible joint with guard
- Star-delta starting (AST)
- Stainless steel water tank
- Electric cable length 5 m



MOD	COD	MAX	MAX		NET					
		bar	psi	l/h	gph	kW	rpm	Hz	V	kg
1130	22376	500	7250	1320	348	26	1450	50	400 3~	280

Accessori standard Standard accessories





12 Series 1230.1240

IDROPULTRICI ALTA PRESSIONE
high pressure washers

HEAVYPRO



manometro
pressure gauge



segnalazione
d'errore tramite spia
intermittente
system error
warning light



filtro ingresso
acqua ispezionabile
inspectable water
intake filter



pedini antivibranti
damper feet



Caratteristiche Generali

- Pompa a 3 pistoni in ceramica, con sistema biella- manovella
- Valvola di by-pass automatica con azzeramento della pressione nella testa della pompa
- Total Stop Temporizzato
- Arresto per microperdite
- Arresto per mancanza d'acqua
- Arresto per surriscaldamento motore
- Segnalazione d'errore tramite spia intermittente
- Motore elettrico trifase
- Regolazione pressione
- Aspirazione detergente incorporata in alta pressione
- Lunghezza cavo elettrico 5 m

General Features

- Triplex pump with ceramic pistons and connecting rod system
- Automatic by-pass valve with pump head pressure discharge
- Time delayed auto stop/start
- Stop for leak detention
- Stop for lack of water
- Stop for motor overloading
- System error warning light
- Heavy-duty three-phase motor
- Pressure adjustment
- HP built-in detergent suction
- Electric cable length 5 m

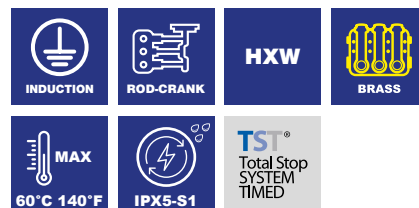

MOD	COD	MAX		MAX		MAX				KG NET
		bar	psi	l/h	gph	kW	rpm	Hz	V	
1230	22377	150	2200	900	238	5	1450	50	400 3~	72
1240	22378	200	2900	900	238	7,4	1450	50	400 3~	75

Accessori standard Standard accessories

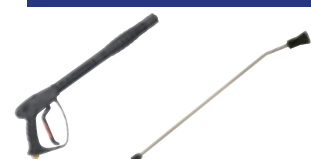

41089

50246
(50 cm)



3091 (1230/25045)
3087 (1240/2504)



HEAVYPRO

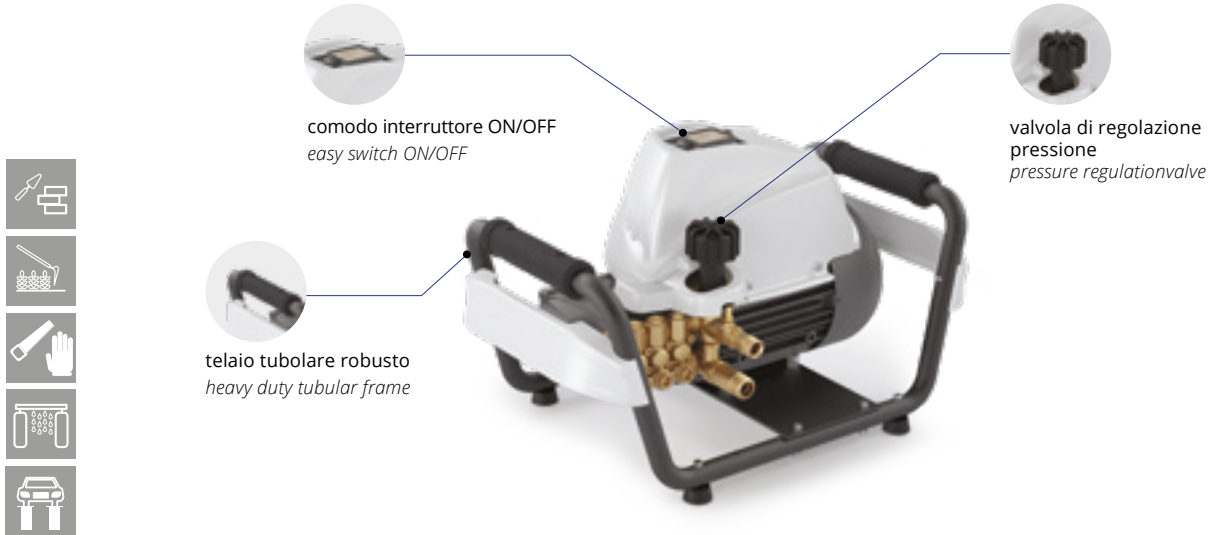

Caratteristiche Generali

- Idropultrice speciale, con robusto telaio tubolare verniciato per proteggere l'unità da urti.
- Pompa assiale con sistema biella-manovella a tre pistoni in ceramica integrale e testata in ottone.
- Motore elettrico a 4 poli, a basso regime di giri, per un migliore lifetime della pompa
- Motore elettrico a induzione monofase con protezione termica (1250S)
- Motore elettrico a induzione trifase con protezione termica (1255S)
- Filtro integrato per proteggere la pompa da particelle di sporco facilmente estraibile.
- Valvola di by-pass automatica con azzeramento della pressione nella testa della pompa.
- Spegnimento automatico della pompa al rilascio della leva pistola per un maggior risparmio energetico anche a distanza dalla macchina senza intervenire sull' interruttore per brevi tempi di non utilizzo.
- Accessori professionali a corredo.
- Ideale per il settore edile, automotive e movimento terra

General Features

- Special high pressure washer, with rugged painted tubular frame for impact-protection.
- Axial pump with crank-connecting rod mechanism, three all-ceramic pistons and brass pump head.
- 4-pole motor with low rpm for longer pump lifetime.
- Single-phase electric induction motor with overload cutout (1250S).
- Three-phase induction motor with overload cutout (1255S).
- Easily removable integral filter to protect the pump from dirt particles.
- Automatic by-pass valve for pump head pressure shut-off.
- Pump automatically stops when gun trigger is released, for greater energy savings even at a distance from the unit, with no need to operate the switch for short interruptions in use.
- Complete with professional accessories.
- Ideal for the construction, automotive and earthmoving sectors.



MOD	COD	MAX	MAX							KG NET
		bar	psi	l/h	gph	kW	rpm	Hz	V	kg
1250S	26360	150	2200	630	159	3	1450	50	230~	33,5
1255S ^o	26332	150	2200	900	238	5	1450	50	400 3~	36

Accessori standard Standard accessories





12 Series 1260S.1270S

IDROPULTRICI ALTA PRESSIONE
high pressure washers

HEAVYPRO

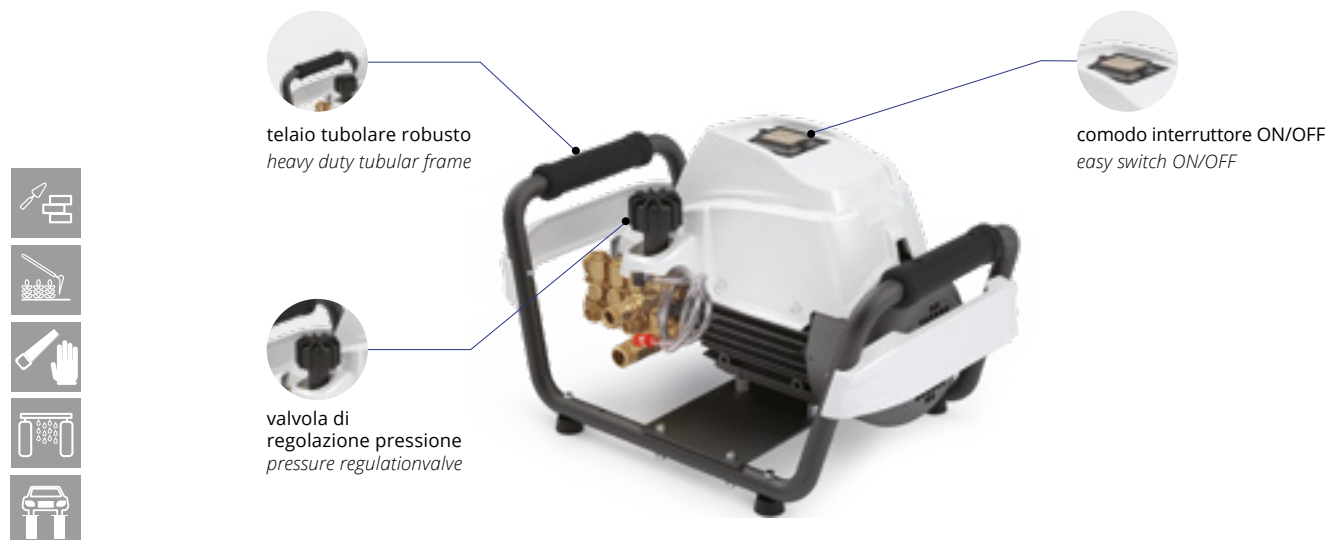

Caratteristiche Generali

- Idropulitrice speciale, con robusto telaio tubolare verniciato per proteggere l'unità da urti.
- Pompa assiale con sistema biella-manovella a tre pistoni in ceramica integrale e testata in ottone.
- Motore elettrico a 4 poli, a basso regime di giri, per un migliore lifetime della pompa.
- Motore elettrico a induzione trifase con protezione termica.
- Filtro integrato per proteggere la pompa da particelle di sporco facilmente estraibile.
- Valvola di by-pass automatica con azzeramento della pressione nella testa della pompa.
- Spegnimento automatico della pompa al rilascio della leva pistola per un maggior risparmio energetico anche a distanza dalla macchina senza intervenire sull'interruttore per brevi tempi di non utilizzo.
- Accessori professionali a corredo.
- Ideale per il settore edile, automotive e movimento terra

General Features

- Special high pressure washer, with rugged painted tubular frame for impact-protection.
- Axial pump with crank-connecting rod mechanism, three all-ceramic pistons and brass pump head.
- 4-pole motor with low rpm for longer pump lifetime.
- Three-phase induction motor with overload cutout.
- Easily removable integral filter to protect the pump from dirt particles.
- Automatic by-pass valve for pump head pressure shut-off.
- Pump automatically stops when gun trigger is released, for greater energy savings even at a distance from the unit, with no need to operate the switch for short interruptions in use.
- Complete with professional accessories.
- Ideal for the construction, automotive and earthmoving sectors.

		1260S	1270S
		HRR	HRK

MOD	COD									
		bar	psi	l/h	gph	kW	rpm	Hz	V	kg
1260S ^o	26361	200	2900	900	238	7,4	1450	50	400 3~	47
1270S ^o	26362	150	2200	1260	333	7,4	1450	50	400 3~	48

Accessori standard Standard accessories



HEAVYPRO

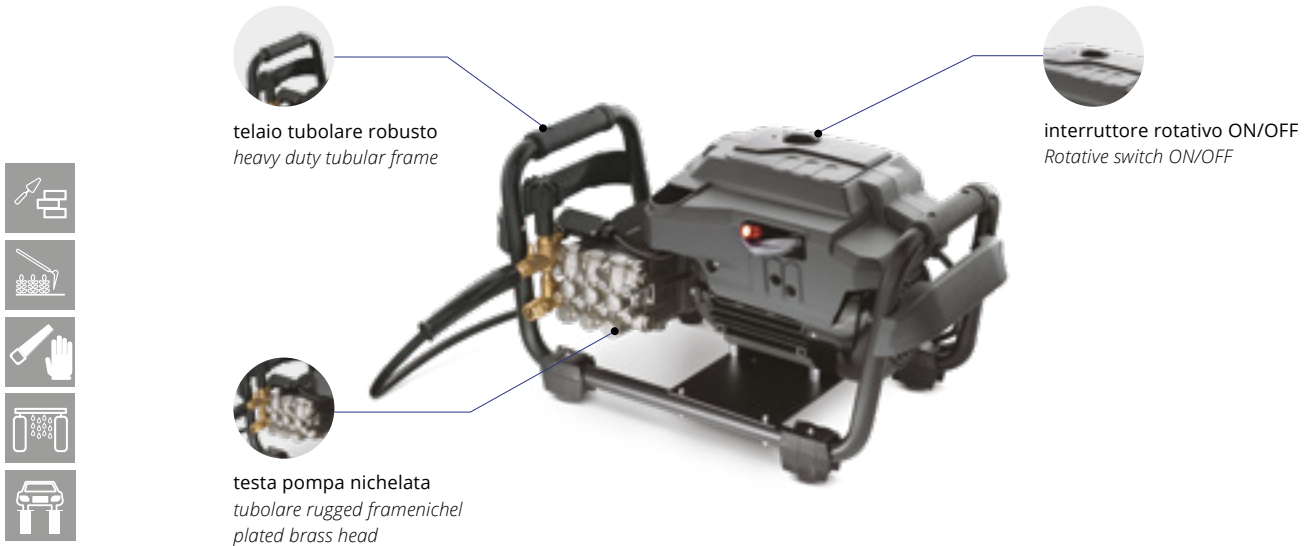

Caratteristiche Generali

- Idropulitrice speciale, con robusto telaio tubolare verniciato per proteggere l'unità da urti.
- Pompa assiale con sistema biella-manovella a tre pistoni in ceramica integrale e testata in ottone.
- Motore elettrico a 4 poli, a basso regime di giri, per un migliore lifetime della pompa
- Motore elettrico a induzione trifase con protezione termica.
- Filtro integrato per proteggere la pompa da particelle di sporco facilmente estraibile.
- Valvola di by-pass automatica con azzeramento della pressione nella testa pompa.
- Spegnimento automatico della pompa al rilascio della leva pistola per un maggior risparmio energetico anche a distanza dalla macchina senza intervenire sull'interruttore per brevi tempi di non utilizzo.
- Accessori professionali a corredo.
- Ideale per il settore edile, automotive e movimento terra
- Bielle in bronzo (26267).

General Features

- Special high pressure washer, with rugged painted tubular frame for impact-protection.
- Axial pump with crank-connecting rod mechanism, three all-ceramic pistons and brass pump head.
- 4-pole motor with low rpm for longer pump lifetime.
- Three-phase induction motor with overload cutout.
- Easily removable integral filter to protect the pump from dirt particles.
- Automatic by-pass valve for pump head pressure shut-off.
- Pump automatically stops when gun trigger is released, for greater energy savings even at a distance from the unit, with no need to operate the switch for short interruptions in use.
- Complete with professional accessories.
- Ideal for the construction, automotive and earthmoving sectors.
- Bronze connecting rods (26267).

MOD	COD	MAX	MAX							KG NET
		bar	psi	l/h	gph	kW	rpm	Hz	V	kg
1280S ^o	26291	150	2200	900	238	5,5	1450	50	400 3~	53
1290S ^o	26267	200	2900	900	238	7,5	1450	50	400 3~	53,5



1280S		1290S	
HRG	BRASS	HRW	NICHEL PLATED
INDUCTION	ROD-CRANK	60°C 140°F	IPX5-S1
TSS ^o Total Stop SYSTEM			

Accessori standard

Standard accessories

41045 46221 (56 cm) 1700980 (10 m)

3084 (1280S/1506)
3086 (1290S/15045)

GAMMA CON PRESTAZIONI ELEVATE

TOP-OF-THE LINE RANGE



14 NEW SERIES

Gamma completa e profonda di idropulitrici con motore a scoppio, che non necessitano di alimentazione elettrico, perfette quindi per utilizzi in cantieri e nel settore edile.

I telai robusti ed ergonomici assicurano un'extra durata ed i pneumatici gonfiabili ed i larghi battistrada rivestiti in gomma garantiscono un'estrema manovrabilità anche sulle superfici più sconnesse. Dotazione di accessori professionali per garantire sempre una potenza eccezionale ed un perfetto potere pulente.

14 NEW SERIES

A wide, complete range of high pressure washers with internal combustion engines, which do not need an electricity supply and are therefore perfect for uses on construction sites and in the building industry.

The rugged, ergonomic frames guarantee exceptional durability and the inflatable tyres and wide rubber treads ensure excellent manoeuvrability on even the most uneven ground.

A range of professional accessories to guarantee outstanding power and perfect cleaning power at all times.

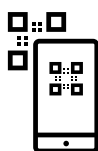

- **FACILE DA MANOVRARE**
EASY-TO-MOVE
- **DESIGN ERGONOMICO**
ERGONOMIC DESIGN
- **MASSIMA FLESSIBILITÀ**
EXTREME FLEXIBILITY



UNIQUE DETAILS

- 1 ROBUSTO CARRELLO IN METALLO**
Solid metal frame
- 2 BATTISTRADA RICOPERTI IN GOMMA**
Rubber tread wheels
- 3 PORTA-ACCESSORI INTEGRATO**
Built-in accessories holder
- 4 PIEDINI ANTI-VIBRAZIONE**
Anti-vibration feets
- 5 PNEUMATICI GONFIABILI AD ALTA AFFIDABILITÀ**
Never-go-flat wheels
- 6 PRATICA IMPUGNATURA ANTI-SCIVOLO**
Soft-grip handle

COMPATTA E INDIPENDENTE SENZA ELETTRICITÀ

COMPACT & INDEPENDENT



14 New Series

THE POWER OF CLEANING

Idropultrici extra-flessibili - indipendenti dall'alimentazione elettrica. Alimentate a benzina o diesel, sono la soluzione ideale per la pulizia nel settore agricolo ed edile dove sono richieste prestazioni elevate ed un'estrema manovrabilità. Robuste e prestanti sono la risposta migliore per questo tipo di utilizzi gravosi e continuati. Le pompe montate su queste idropultrici sono costruite utilizzando esclusivamente materiali di qualità e anti-corrosione, quali l'ottone. Offrono quindi una lunga durata ed un'estrema facilità di manutenzione.

THE POWER OF CLEANING

Highly versatile high pressure washers - with no electricity supply needed. Operating on petrol or diesel, they are the ideal solution for cleaning in the farming and construction sectors, where high performance and extreme manoeuvrability are required. Tough and high-performing, they are the best solution for this type of heavy-duty, continuous use. The pumps installed on these high pressure washers are built only from top quality, corrosion-resistant materials, such as brass. This ensures a long working lifetime and exceptionally easy maintenance.

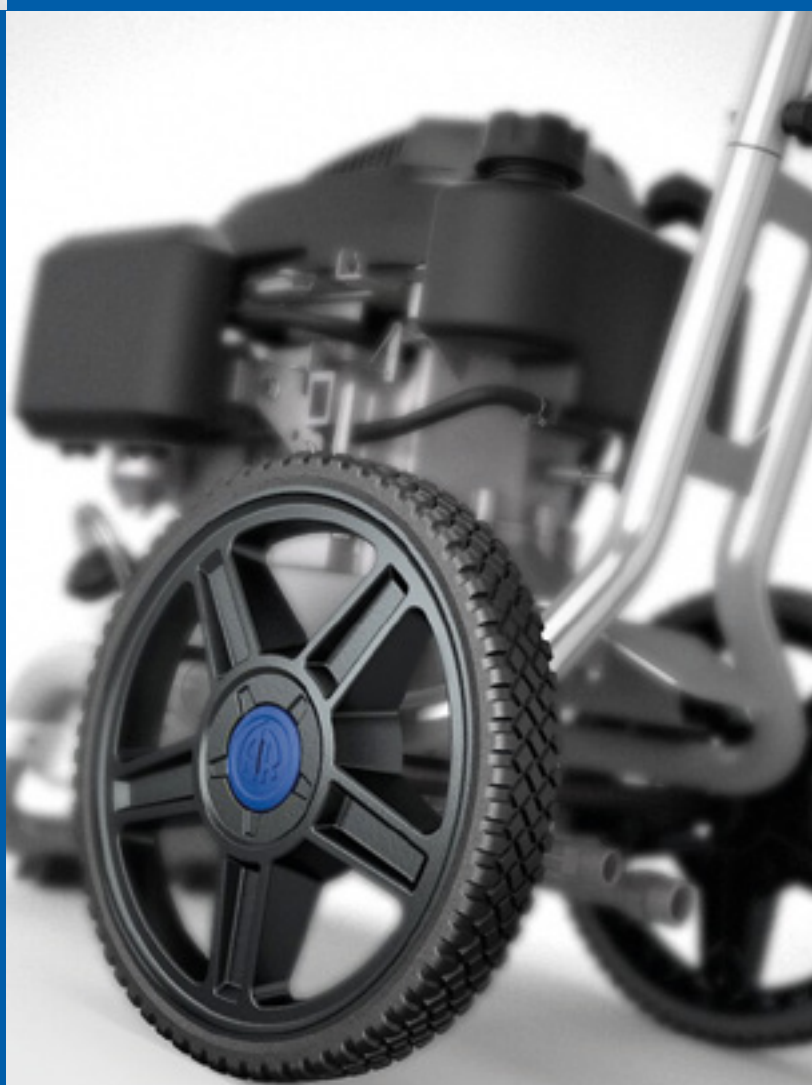

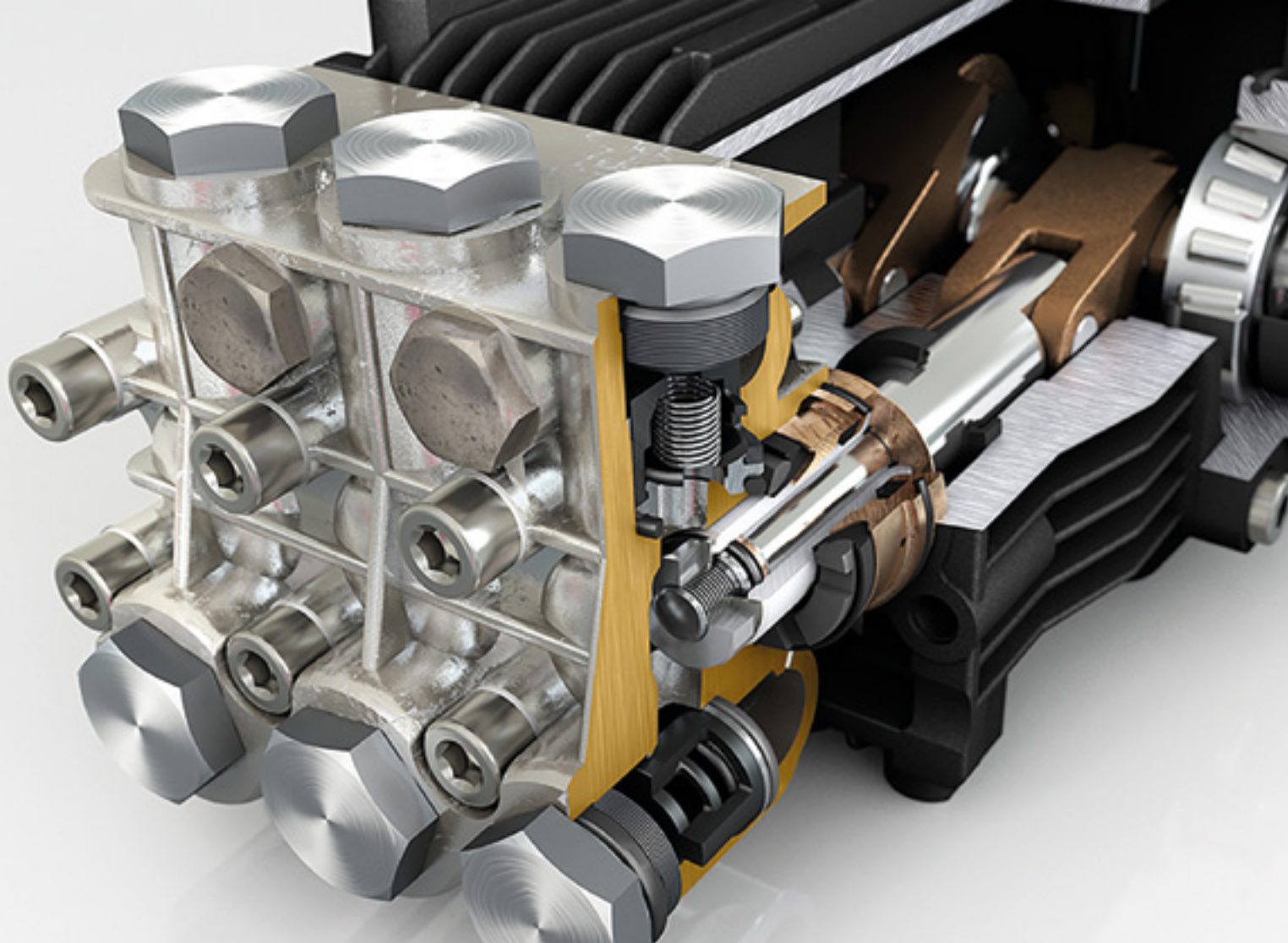

POMPA modello RK

PUMP MODEL RK

POMPA AR AD ALTE PRESTAZIONI
Long-lasting ar pump

TESTA POMPA IN OTTONE FORGIATO
Forged brass pump head

SISTEMA BIELLA-MANOVELLA
Connecting rod-system

CONTROLLO QUALITÀ AR GARANTITA AL 100%
100% Ar quality control system





14 Series 1415

IDROPULITRICI CON MOTORE A SCOPPIO
petrol engine pressure washers

OLIGHTPRO



Caratteristiche Generali

- Telaio completo di manico con piedini antivibranti
- Pompa a 3 pistoni assiali comandati dal piattello oscillante
- Valvola di by-pass automatica
- Valvola termica
- Aspirazione detergente incorporata
- Aspirazione detergente regolabile
- Motorizzato Rato (benzina), con sensore mancanza olio
- Livelli olio ispezionabili
- Tappi ed asole di scarico per agevolare la manutenzione ed il cambio olio
- Filtro acqua ispezionabile
- Soluzioni studiate per ottimizzare gli ingombri

General Features

- Metal frame with handle and anti-vibrating feet
- 3 Axial stainless steel pistons wobble-plate pump
- Automatic by-pass valve
- Thermal valve
- Built-in detergent suction
- Powered by Rato petrol engine with low oil level sensor
- Inspectable oil levels
- Discharge plugs and discharge slots to make easy the maintenance and the oil change
- Inspectable water filter
- Space-saving solutions



MOD	COD	MAX	MAX		NET			Engine	Engine Type	kg
		bar	psi	l/h	gph	rpm				
1415	26213	130	1900	420	111	3400	EHRS100	RATO		17,3

Accessori standard Standard accessories





OLIGHTPRO



Caratteristiche Generali

- Carrello completo di manico con due ruote e piedini antivibranti
- Pompa a 3 pistoni assiali comandati dal piattello oscillante
- Valvola di by-pass automatica
- Regolazione della pressione
- Valvola termica
- Aspirazione detergente incorporata
- Motorizzato Rato (benzina), con sensore mancanza olio
- Livelli olio ispezionabili
- Tappi ed asole di scarico per agevolare la manutenzione ed il cambio olio
- Filtro acqua ispezionabile
- Soluzioni studiate per ottimizzare gli ingombri

General Features

- Two-wheel trolley with tyres, handle and anti-vibrating feet
- 3 Axial stainless steel pistons wobble-plate pump
- Automatic by-pass valve
- Thermal valve
- Built-in detergent suction
- Powered by Rato petrol engine with low oil level sensor
- Inspectable oil levels
- Discharge plugs and discharge slots to make easy the maintenance and the oil change
- Inspectable water filter
- Space-saving solutions

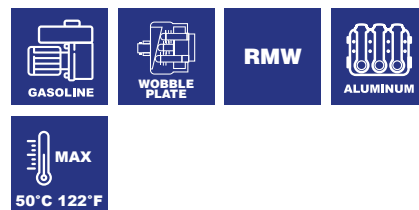

MOD	COD	MAX	MAX			Engine	Engine Type	kg NET	
		bar	psi	l/h	gph	rpm			
1425	26215	160	2300	480	127	3400	EHRV175	RATO	25,9



Accessori standard

Standard accessories



- 3600400 (low pressure) Nero/Black
- 3600440 (0003) Rosso/Red
- 3600450 (1503) Giallo/Yellow
- 3600470 (4003) Bianco/White



14 Series 1435

IDROPULTRICI CON MOTORE A SCOPPIO
petrol engine pressure washers

OLIGHTPRO



Caratteristiche Generali

- Carrello completo di manico con due ruote e piedini antivibranti
- Pompa a 3 pistoni assiali comandati dal piattello oscillante
- Valvola di by-pass automatica
- Regolazione della pressione
- Valvola termica
- Aspirazione detergente incorporata
- Motorizzato Loncin (benzina), con sensore mancanza olio
- Livelli olio ispezionabili
- Tappi ed asole di scarico per agevolare la manutenzione ed il cambio olio
- Filtro acqua ispezionabile
- Soluzioni studiate per ottimizzare gli ingombri

General Features

- Two-wheel trolley with tyres, handle and anti-vibrating feet
- 3 Axial stainless steel pistons wobble-plate pump
- Automatic by-pass valve
- Pressure adjustment
- Thermal valve
- Built-in detergent suction
- Powered by Loncin petrol engine with low oil level sensor
- Inspectable oil levels
- Discharge plugs and discharge slots to make easy the maintenance and the oil change
- Inspectable water filter
- Space-saving solutions

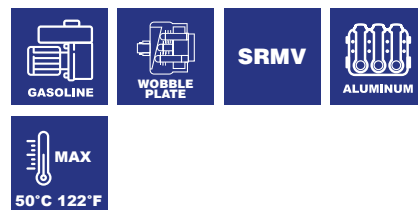

MOD	COD	MAX	MAX			Engine	Engine Type	kg NET	
		bar	psi	l/h	gph	rpm			
1435	26406	200	2900	660	174	3400	GP160F	LONCIN	31,8

Accessori standard

Standard accessories



- 3600400 (low pressure) Nero/Black
- 3600930 (00035) Rosso/Red
- 3600940 (15035) Giallo/Yellow
- 3600960 (40035) Bianco/White





OLIGHTPRO



Caratteristiche Generali

- Carrello completo di manico con due ruote e piedini antivibranti
- Pompa a 3 pistoni assiali comandati dal piattello oscillante
- Valvola di by-pass automatica
- Valvola termica
- Aspirazione detergente incorporata
- Motorizzato Honda (benzina), con sensore mancanza olio
- Livelli olio ispezionabili
- Tappi ed asole di scarico per agevolare la manutenzione ed il cambio olio
- Filtro acqua ispezionabile
- Soluzioni studiate per ottimizzare gli ingombri

General Features

- Two-wheel trolley with tyres, handle and anti-vibrating feet
- 3 Axial stainless steel pistons wobble-plate pump
- Automatic by-pass valve
- Thermal valve
- Built-in detergent suction
- Powered by Honda petrol engine with low oil level sensor
- Inspectable oil levels
- Discharge plugs and discharge slots to make easy the maintenance and the oil change
- Inspectable water filter
- Space-saving solutions



MOD	COD	MAX	MAX			Engine	Engine Type	kg NET	
		bar	psi	l/h	gph	rpm			
1440	26216	200	2900	660	174	3400	GP160H	HONDA	31,4

Accessori standard

Standard accessories



- 3600400 (low pressure) Nero/Black
- 3600930 (00035) Rosso/Red
- 3600940 (15035) Giallo/Yellow
- 3600960 (40035) Bianco/White





14 Series 1445

IDROPULITRICI CON MOTORE A SCOPPIO
petrol engine pressure washers

OLIGHTPRO



porta accessori
built-in accessories holder



filtro ingresso
acqua ispezionabile
inspectable water
intake filter



valvola termica
thermal valve



manico ergonomico
ergonomic handle



telaio in acciaio
verniciato
painted steel frame



battistrada in gomma
rubber wheels

Caratteristiche Generali

- Carrello completo di manico con due ruote e piedini antivibranti
- Pompa a 3 pistoni assiali comandati dal piattello oscillante
- Valvola di by-pass automatica
- Regolazione della pressione
- Valvola termica
- Aspirazione detergente incorporata
- Motorizzato Rato (benzina), con sensore mancanza olio
- Livelli olio ispezionabili
- Tappi ed asole di scarico per agevolare la manutenzione ed il cambio olio
- Filtro acqua ispezionabile
- Soluzioni studiate per ottimizzare gli ingombri

General Features

- Two-wheel trolley with tyres, handle and anti-vibrating feet
- 3 Axial stainless steel pistons wobble-plate pump
- Automatic by-pass valve
- Pressure adjustment
- Thermal valve
- Built-in detergent suction
- Powered by Rato petrol engine with low oil level sensor
- Inspectable oil levels
- Discharge plugs and discharge slots to make easy the maintenance and the oil change
- Inspectable water filter
- Space-saving solutions



MOD	COD	MAX	MAX			Engine	Engine Type	kg	
		bar	psi	l/h	gph	rpm			
1445	26407	220	3200	660	174	3400	EHR210	RATO	31,7

Accessori standard Standard accessories



43525

3600650
(49 cm)

3780493 (8 m)



- 3600400 (low pressure) Nero/Black
- 3600930 (00035) Rosso/Red
- 3600940 (15035) Giallo/Yellow
- 3600960 (40035) Bianco/White



HEAVYPRO



Caratteristiche Generali

- Carrello completo di manico con due ruote e piedini antivibranti
- Pompa a pistoni con sistema biella-manovella ad elevate prestazioni
- Valvola di by-pass automatica
- Regolazione della pressione
- Valvola termica
- Aspirazione detergente incorporata
- Motorizzato Honda (benzina), con sensore mancanza olio
- Livelli olio ispezionabili
- Tappi ed asole di scarico per agevolare la manutenzione ed il cambio olio
- Filtro acqua ispezionabile
- Soluzioni studiate per ottimizzare gli ingombri

General Features

- Two-wheel trolley with tyres, handle and anti-vibrating feet
- High performance piston pump with connecting rod system
- Automatic by-pass valve
- Pressure adjustment
- Thermal valve
- Built-in detergent suction
- Powered by Honda petrol engine with low oil level sensor
- Inspectable oil levels
- Discharge plugs and discharge slots to make easy the maintenance and the oil change
- Inspectable water filter
- Space-saving solutions

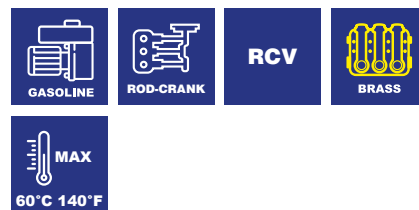

MOD	COD	MAX	MAX			Engine	Engine Type	kg	
		bar	psi	l/h	gph	rpm			
1450	26217	220	3200	720	190	3400	GP200H	HONDA	34,7

Accessori standard Standard accessories



- 3600400 (low pressure) Nero/Black
- 3600930 (00035) Rosso/Red
- 3600940 (15035) Giallo/Yellow
- 3600960 (40035) Bianco/White





14 Series 1460.1475.1480

IDROPULITRICI CON MOTORE A SCOPPIO
petrol engine pressure washers

HEAVYPRO



porta accessori
built-in accessories holder



filtro ingresso
acqua ispezionabile
inspectable water
intake filter



valvola termica
thermal valve



manico ergonomico
ergonomic handle

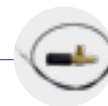

regolatore automatico acceleratore
automatic throttle control
Mod. 1475-1480



telaio in acciaio
verniciato
painted steel frame



battistrada in gomma
rubber wheels

Caratteristiche Generali

- Carrello completo di manico con due ruote pneumatiche gonfiabili e piedini antivibranti
- Pompa a pistoni con sistema biella-manovella ad elevate prestazioni
- Valvola di by-pass automatica
- Regolazione della pressione
- Valvola termica
- Aspirazione detergente incorporata
- Motorizzato Honda/Loncin (benzina), con sensore mancanza olio
- Livelli olio ispezionabili
- Tappi ed asole di scarico per agevolare la manutenzione ed il cambio olio
- Filtro acqua ispezionabile
- Soluzioni studiate per ottimizzare gli ingombri

General Features

- Two-wheel trolley with handle, inflatable pneumatic wheels and anti-vibrating feet
- High performance piston pump with connecting rod system
- Automatic by-pass valve
- Pressure adjustment
- Thermal valve
- Built-in detergent suction
- Powered by Honda/Loncin petrol engine with low oil level sensor
- Inspectable oil levels
- Discharge plugs and discharge slots to make easy the maintenance and the oil change
- Inspectable water filter
- Space-saving solutions



MOD	COD	MAX	MAX			Engine	Engine Type	kg NET	
		bar	psi	l/h	gph	rpm			
1460	26218	270	4000	900	238	3400	GX270	HONDA	53,5
1475	26325	280	4060	960	254	3400	G390F	LONCIN	58,4
1480	26219	280	4060	960	254	3400	GX390	HONDA	58,6

Accessori standard Standard accessories



43524 3600650 (49 cm) 1700981 (10 m)



1460 1475.1480
 3600400 (low p.) 3600400 (low p.) Nero/Black
 3600930 (00035) 3600350 (0004) Rosso/Red
 3600940 (15035) 3600360 (1504) Giallo/Yellow
 3600960 (40035) 3600380 (4004) Bianco/White





HEAVYPRO



Caratteristiche Generali

- Carrello completo di manico con due ruote pneumatiche gonfiabili e piedini antivibranti
- Pompa a pistoni con sistema biella-manovella ad elevate prestazioni
- Valvola di by-pass automatica
- Regolazione della pressione
- Valvola termica / Riduttore di giri
- Aspirazione detergente incorporata
- Motorizzato Honda (benzina), con sensore mancanza olio
- Livelli olio ispezionabili, per pompa e riduttore
- Tappi ed asole di scarico per agevolare la manutenzione ed il cambio olio
- Filtro acqua ispezionabile
- Soluzioni studiate per ottimizzare gli ingombri

General Features

- Two-wheel trolley with inflatable tyres, handle and damper feet inflatable pneumatic wheels and anti-vibrating feet
- High performance piston pump with connecting rod system
- Automatic by-pass valve
- Pressure adjustment
- Thermal valve / Gear box
- Built-in detergent suction
- Powered by Honda petrol engine with low oil level sensor
- Inspectable oil levels for pump and gear box
- Discharge plugs and discharge slots to make easy the maintenance and the oil change
- Inspectable water filter
- Space-saving solutions



MOD	COD	MAX	MAX						KG NET
		bar	psi	l/h	gph	rpm	Engine	Engine Type	kg
1490	26408	280	4060	960	254	1750	GX390	HONDA	64
1492	27348	250	3626	1320	350	1750	GX390	HONDA	64

Accessori standard Standard accessories



43524 3600650 (49 cm) 1700981 (10 m)



3600400 (low pressure) Nero/Black
3600350 (0004) Rosso/Red
3600360 (1504) Giallo/Yellow
3600380 (4004) Bianco/White















ACCESSORI









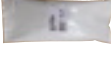







Accessories



		6 Series											7 Series					9 Series								
		610	625	630	650	630K	613	614	615	613K	614K	615K	670	671	672	737	747	767	780	787	797	930	940	950	970	990
Pistola Trigger gun		40925	S	S	S	S	S	S	S	S	S	S	S	S	S	S	S	S								
		41046																	S	S	S					
		43794																				S	S	S		
		43811																							S	S
Lancia getto regolabile Lance with adjustable spray nozzle		40030 (51 cm)	S																							
		40039 (51 cm)		S	S																					
		40113 (51 cm)				S																				
		46056 (49 cm)					S																			
		41269 (49 cm)						S		S																
		41806 (49 cm)							S		S															
		41747 (49 cm)								S		S														
		41553 (49 cm)														S										
		40751 (49 cm)															S									
		41555 (49 cm)																S								
		40713 (49 cm)																	S							
		41554 (49 cm)																		S						
		40823 (49 cm)																			S					
		41929 (47 cm)																				S				
		43954 (47 cm)											S													
		43955 (47 cm)												S												
		43956 (47 cm)													S											
Estensione lancia Lance extension		46221 (56 cm)																				S	S	S	S	
Ugelli Wash nozzles 1/4 MEG		3095 (15055)																				S				
		3083 (1505)																					S			
		3086 (15045)																						S		
		3157 (1508)																							S	
		40638 (56 cm)	O																	O	O					
Lancia getto rotante Rotary lance		40167 (56 cm)					O			O																
		40169 (56 cm)										O	O	O												
		40151 (56 cm)						O		O				O												
		40901 (56 cm)							O		O															
		40900 (56 cm)		O	O		O													O						
		40844 (56 cm)				O										O	O	O								
Lancia getto rotante PRO Rotary lance PRO		40968 (56 cm)																			O					
		40803 (56 cm)																					O	O		
		40966 (56 cm)																					O			
		40969 (56 cm)																							O	
Tubo AP Hose HP		3780492 (8 m)	S																							
		1271351 (10 m)		S	S	S	S																			



		6 Series											7 Series					9 Series									
		610	625	630	650	630K	613	614	615	613K	614K	615K	670	671	672	737	747	767	780	787	797	930	940	950	970	990	
Tubo armato AP Reinforced HP hose		3780491 (8 m)					S	S	S				S	S	S												
		3780441 (10 m)								S	S	S															
Tubo armato AP Reinforced HP hose		1271960 (10 m)													S	S	S	S	S	S							
		3960970 (10 m)																				S					
		3961050 (10 m)																				S	S	S	S		
Prolunga tubo armato Reinforced extension hose		40106 incluso nel kit / included in kit	O	O	O	O	O	O	O	O	O	O	O	O	O	O	O	O	O	O	O	O	O	O	O	O	
		1123890																									
Kit schiumogeno alta pressione High pressure foam lance bottle		41552	O	O	O	O	O	O	O	O	O	O	O	O	O	O	O	O	O	O	O	O	O	O	O	O	
Kit pulizia tubazioni Pipe drain kit		46364 (8 m)	O	O	O	O	O	O	O	O	O	O	O	O	O	O	O	O	O	O	O	O	O	O	O		
		46365 (8 m)																								O	
		46366 (16 m)	O	O	O	O	O	O	O	O	O	O	O	O	O	O	O	O	O	O	O	O	O	O	O	O	O
		46367 (16 m)																									O
Spazzola fissa Fixed brush		41577	O	O	O	O	O	O	O	O	O	O	O	O	O	O	O	O	O								
Spazzola rotante Rotary brush		41578	O	O	O	O	O	O	O	O	O	O	O	O	O	O	O	O									
Spazzola rotante PRO Rotary brush PRO		46370																	O	O	O	O	O	O	O		
		46371																								O	
Lavapavimenti d. 30 cm Patio cleaner d. 30 cm		41687	O	O	O	O	O	O	O	O	O	O	O	O	O	O	O	O									
Lavapavimenti PRO con regolazione pressione Patio cleaner w. pressure adjustment		46359	O	O	O	O	O	O	O	O	O	O	O	O	O	O	O	O									
Lavapavimenti PRO con regolazione pressione Patio cleaner w. pressure adjustment		46368	O	O			O	O		O	O		O	O		O	O	O									
		46369			O	O			O		O				O				O		O	O			O		
Kit lancia sabbiante PRO Sandblasting lance kit PRO		41591 (50 cm)	O	O			O	O		O	O		O	O		O	O	O									
		41762 (50 cm)			O				O		O				O				O	O	O	O	O	O	O		
		41763 (50 cm)																		O	O	O	O	O	O	O	
Sabbia calibrata e filtrata Calibrated, filtered sand		3207 (5 Kg)	O	O	O	O	O	O	O	O	O	O	O	O	O	O	O	O	O	O	O	O	O	O	O	O	
		41770 (25 Kg)	O	O	O	O	O	O	O	O	O	O	O	O	O	O	O	O	O	O	O	O	O	O	O	O	

		6 Series											7 Series						9 Series							
		610	625	630	650	630K	613	614	615	613K	614K	615K	670	671	672	737	747	767	780	787	797	930	940	950	970	990
Kit aspirazione acqua <i>Water suction kit</i>		41592	o	o	o	o	o	o	o	o	o	o	o	o	o	o	o	o	o	o	o	o	o	o	o	o
		41590 (1503-80cm)			o		o	o		o	o		o	o		o	o									
		41752 (15035-80cm)																o								
Kit lancia sottoscocca <i>Underbody lance kit</i>		41751 (1504-80 cm)	o					o				o			o			o			o					
		43372 (15045-80cm)		o	o		o													o					o	
		41753 (1505-80 cm)																			o			o		
		46373 (1506-80 cm)																		o			o			
		41754 (1508-80 cm)																							o	
Lancia senza ugello <i>Lance without nozzle</i>		40652 (90 cm)	o	o	o	o	o	o	o	o	o	o	o	o	o	o	o	o	o	o	o	o	o	o	o	
		40653 (120 cm)	o	o	o	o	o	o	o	o	o	o	o	o	o	o	o	o	o	o	o	o	o	o	o	
		40654 (150 cm)	o	o	o	o	o	o	o	o	o	o	o	o	o	o	o	o	o	o	o	o	o	o	o	
		40694 (170 cm)	o	o	o	o	o	o	o	o	o	o	o	o	o	o	o	o	o	o	o	o	o	o	o	
		40695 (200 cm)	o	o	o	o	o	o	o	o	o	o	o	o	o	o	o	o	o	o	o	o	o	o	o	
Lancia doppia <i>Double lance</i>		3160620 (66 cm)																	o	o	o	o	o	o		
Ugello bassa pressione <i>Low pressure nozzle</i>		3251 (2525)																	o	o	o	o	o	o		
Testina doppio ugello <i>Roller nozzle</i>		3025																	o	o	o	o	o	o		
Kit adattatori <i>Adapters kit</i>		41758	o	o	o	o	o	o	o	o	o															
Filtro acqua ispezionabile <i>Inspectable water filter</i>		41663 (3 pcs)	s					s	s	s	s	s	s	s	s	s	s	s	s	s	s	s	s	s		
Kit filtro acqua <i>Water filter kit</i>		41593	o	o	o	o	o	o	o	o	o	o	o	o	o	o	o	o	o	o	o	o	o	o		
Kit attacco rapido <i>Click fast kit</i>		41580	o	o	o	o	o	o	o	o	o	o	o	o	o	o	o	o	o	o	o	o	o	o		
Kit attacco rapido ottone <i>Brass click fast kit</i>		40439	o					o	o	o	o	o	o	o	o	o	o	o	o	o	o	o	o	o		
		40440		o	o	o	o																			
Kit RLW senza tubo <i>Hose reel kit without hose</i>		41738				o	o	o	o	o	o	o	o	o												
		40644												o	o											
		40645																o	o	o	o					
Kit RLW con 15 m tubo AP <i>with HP hose 15 m</i>		41879				o				o	o	o														
		40377												o	o											
		40340																o	o	o	o					
Kit carrello <i>Trolley kit</i>		41869					o	o	o																	
		43972		o	o	o							o	o	o											
Kit avvolgitubo a muro senza tubo <i>Wall mounted hose reel without hose kit</i>		41739				o	o	o	o	o	o															
Kit avvolgitubo a muro con tubo 15 m <i>Wall mounted hose reel with hose 15 m</i>		41880				o	o	o	o	o	o															

10·11·12·14 Series

ACCESSORI
accessories









		10 Series										11 Series		12 Series				14 Series																					
		1000K	1001K	1003K	1004K	1001	1003	1004	1007	1008	1010N	1015N	1018	1018H	1120	1125	1130	1230	1240	1250S	1255S	1260S	1270S	1280S	1290S	1415	1425	1435	1440	1445	1450	1460	1475	1480	1490	1492			
Pistola Trigger gun		40925	S	S	S	S	S	S												S	S							S	S	S									
		43525																												S	S								
		41046						S																															
		41045						S	S													S	S	S	S														
		41089								S	S	S	S					S	S																				
		41847													S																								
		51156														S																							
		50926															S																						
Lancia getto regolabile Lance with adjustable spray nozzle		41269 (40 cm)	S	S																																			
		41747 (40 cm)			S																																		
		41748 (40 cm)				S																																	
Lancia con testina alta/ bassa senza ugello Lance with high/low pressure head w/out nozzle		46221 (56 cm)	O	O	O	O	O	O	O	O	S	S	S	S						S	S	S	S	S	S	O	O	O	O	O	O	O	O	O	O	O			
		50246 (50 cm)																S	S																				
Lancia con testina fissa senza ugello Lance with fixed head w/ out nozzle		50261 (50 cm)													S																								
		50690											S																										
Prolunga lancia Lance Extension		3600650 (49 cm)				S	S	S	S	S																	S	S	S	S	S	S	S	S	S	S			
		46332 (42 cm)																							S														
Lancia senza ugello Lance w/out nozzle		50262													S																								
Testina getto regolabile Adjustable jet nozzle		4381820																							S														
Ugelli Wash nozzles 1/4 MEG ***		3104 (1503)	O	O																						O			O										
		3195 (15035)																										O	O		O	O							
		3082 (1504)		O	O															S															O	O	O		
		3086 (15045)					O			S	S										S	S		S															
		3083 (1505)					O			S											S																		
		3095 (15055)			O					S																													
	3084 (1506)																								S														















(***) Per modelli/For models: 1000K, 1001K, 1003K, 1004K, 1001, 1003, 1004, 1007, 1008, 1425, 1440, 1435, 1450, 1445, 1460, 1475, 1480, 1490: occorre comprare la lancia cod. 46221 per montare gli ugelli tipo MEG/ Buy even lance code 46221 to use MEG tupe nozzles

		10 Series										11 Series		12 Series				14 Series																				
		1000K	1001K	1003K	1004K	1001	1003	1004	1007	1008	1010N	1015N	1018	1018H	1120	1125	1130	1230	1240	1250S	1255S	1260S	1270S	1280S	1290S	1415	1425	1435	1440	1445	1450	1460	1475	1480	1490	1492		
Ugelli Wash nozzles 1/4 MEG ***		3250 (15075)								O																												
		3157 (1508)																					S															
		3076 (0004)															S																					
		3087 (2504)																S																				
		3091 (25045)																S																				
		3088 (2505)															S																					
		3089 (2506)														S																						
Ugelli Nozzles		3600400 (bassa p./low p.)				S	S	S	S	S																	S	S	S	S	S	S	S	S	S	S	S	
		3600440 (0003)				S																					S		S									
		3600350 (0004)					S																											S	S	S	S	
		3600720 (0005)						S																														
		3600480 (00045)							S																													
		3600680 (00075)								S																												
		3600930 (00035)																										S	S		S	S						
		3600450 (1503)					S																					S		S								
		3600360 (1504)						S																										S	S	S	S	
		3600730 (1505)							S																													
		3600490 (15045)								S																												
		3600690 (15075)									S																											
		3600940 (15035)																											S	S		S	S					
		3600460 (2503)					S																															
		3600370 (2504)						S																														
		3600740 (2505)							S																													
		3600500 (25045)								S																												
		3600700 (25075)									S																											
		3600470 (4003)					S																						S		S							
		3600380 (4004)						S																											S	S	S	S
	3600750 (4005)							S																														
	3600510 (40045)								S																													
	3600710 (40075)									S																												
	3600960 (40035)																											S	S		S	S						
Lancia getto rotante Rotary lance		40167 (55 cm)				O																																
Lancia getto rotante PRO Rotary lance PRO		41050 (56 cm)		O			O																					O		O								
		40968 (56 cm)		O			O												O										O	O								
		40964 (56 cm)																															O	O	O	O		
		40803 (56 cm)					O		O	O		O	O	O					O		O	O			O													
		40966 (56 cm)									O							O																				
		40965 (56 cm)														O										O												
		40969 (56 cm)								O														O														
Testina getto rotante Rotary jet nozzle		41565																									O											
		40848														O																						
		40395															O																					

















(***) Per modelli/For models: 1000K, 1001K, 1003K, 1004K, 1001, 1003, 1004, 1007, 1008, 1425, 1440, 1435, 1450, 1445, 1460, 1475, 1480, 1490: occorre comprare la lancia cod. 46221 per montare gli ugelli tipo MEG/ Buy even lance code 46221 to use MEG tupe nozzles



	10 Series													11 Series		12 Series				14 Series																										
	1000K	1001K	1003K	1004K	1001	1003	1004	1007	1008	1010N	1015N	1018	1018H	1120	1125	1130	1230	1240	1250S	1255S	1260S	1270S	1280S	1290S	1415	1425	1435	1440	1445	1450	1460	1475	1480	1490	1492											
Tubo AP Hose HP																											S																			
																															S															
																							S																							
																															S S S															
																							S S S S																							
																											S S																			
																																			S											
																							S S																							
																								S S								S S S S														
																																				S S S S S										
																												S S S																		
																												S																		
																												S																		
																												S																		
																											S																			
																											O				O O															
Tubo aspirazione 100°C Suction hose 100°C																							O O O S																							
																											S																			
Prolunga tubo Extension hose																																			O											
																							O O O O O O								O O								O O O							
Prolunga tubo armato Reinforced extension hose																							O O O O O				O				O O				O O O O								O O			
																																											O O O O O			

		10 Series										11 Series		12 Series					14 Series																		
		1000K	1001K	1003K	1004K	1001	1003	1004	1007	1008	1010N	1015N	1018	1018H	1120	1125	1130	1230	1240	1250S	1255S	1260S	1270S	1280S	1290S	1415	1425	1435	1440	1445	1450	1460	1475	1480	1490	1492	
Kit schiumogeno alta pressione <i>High pressure foam lance bottle</i>		41552	○	○	○	○	○	○	○	○	○	○	○	○	○			○	○	○	○	○	○	○	○	○	○	○	○	○	○	○	○	○	○	○	○
		46364 (8 m)	○	○	○	○	○	○	○		○	○						○	○	○	○	○	○	○	○	○	○	○	○	○	○	○	○	○	○	○	○
Kit pulizia tubazioni <i>Pipe drain kit</i>		46365 (8 m)								○				○				○	○	○	○	○	○	○	○	○	○	○	○	○	○	○	○	○	○	○	
		46366 (16 m)	○	○	○	○	○	○	○		○	○							○	○	○	○	○	○	○	○	○	○	○	○	○	○	○	○	○	○	○
		46367 (16 m)								○				○																							
		1272520 (8 m)												○																							
		1272530 (16 m)												○																							
Spazzola fissa <i>Fixed brush</i>		41577	○	○		○	○												○							○	○	○	○	○							
Spazzola rotante <i>Rotary brush</i>		41578	○	○		○																				○	○	○	○								
Spazzola rotante PRO <i>Rotary brush PRO</i>		46370		○	○	○	○	○		○	○	○		○			○	○	○	○	○	○	○	○				○	○	○	○	○	○	○	○	○	
		46371								○													○														
Lavapavimenti con serbatoio detergente d. 30 cm <i>Patio cleaner with detergent tank d. 30 cm</i>		41687	○	○		○																															
Lavapavimenti d. 30 cm <i>Patio cleaner d. 30 cm</i>		43659	○	○		○																					○										
Lavapavimenti PRO con regolazione pressione <i>Patio cleaner PRO with pressure adjustment</i>		46368	○	○		○																															
		46369		○		○	○	○			○	○						○	○	○			○				○	○	○	○	○	○	○	○	○	○	○
Kit lancia sabbiante <i>Sand blasting lance</i>		41760 (50 cm)																									○										
Kit lancia sabbiante PRO <i>Sand blasting lance PRO</i>		41591 (50 cm)	○	○		○	○												○																		
		41762 (50 cm)		○	○			○			○	○						○		○			○			○	○	○	○	○	○	○	○	○	○	○	○
		41763 (50 cm)						○	○	○				○				○		○	○	○	○														
Sabbia calibrata e filtrata <i>Calibrated filtered sand</i>		3207 (5 kg)	○	○	○	○	○	○	○	○	○	○	○	○	○			○	○	○	○	○	○	○	○	○	○	○	○	○	○	○	○	○	○	○	○
		41770 (25 kg)	○	○	○	○	○	○	○	○	○	○	○	○	○			○	○	○	○	○	○	○	○	○	○	○	○	○	○	○	○	○	○	○	○
Kit aspirazione acqua <i>Water suction kit</i>		41592	○	○	○	○	○	○	○		○	○	○					○	○	○	○	○	○	○	○	○	○	○	○	○	○	○	○	○	○	○	○
Adattatore snodato per testine <i>Adjustable head nozzle adaptor</i>		46009																								○											



		10 Series										11 Series		12 Series					14 Series																			
		1000K	1001K	1003K	1004K	1001	1003	1004	1007	1008	1010N	1015N	1018	1018H	1120	1125	1130	1230	1240	1250S	1255S	1260S	1270S	1280S	1290S	1415	1425	1435	1440	1445	1450	1460	1475	1480	1490	1492		
AKit lancia sottoscocca <i>Underbody lance</i>		41590 (1503 - 80 cm)	○	○																							○		○									
		41752 (15035 - 80 cm)																										○	○		○	○						
		41751 (1504 - 80 cm)			○	○	○												○	○	○											○	○	○	○	○	○	
AKit lancia sottoscocca <i>Underbody lance</i>		43372 (15045 - 80 cm)							○			○						○			○		○															
		41753 (1505 - 80 cm)						○				○									○																	
		46373 (1506 - 80 cm)			○							○												○														
Lancia senza ugello <i>Lance w/out nozzle</i>		41754 (1508 - 80 cm)							○													○																
		40652 (90 cm)	○	○	○	○	○	○	○	○	○	○	○	○	○	○	○	○	○	○	○	○	○	○	○	○	○	○	○	○	○	○	○	○	○	○	○	
		40653 (120 cm)	○	○	○	○	○	○	○	○	○	○	○	○	○	○	○	○	○	○	○	○	○	○	○	○	○	○	○	○	○	○	○	○	○	○	○	○
		40654 (150 cm)	○	○	○	○	○	○	○	○	○	○	○	○	○	○	○	○	○	○	○	○	○	○	○	○	○	○	○	○	○	○	○	○	○	○	○	○
Lancia doppia <i>Double lance</i>		3160620 (66 cm)	○	○	○	○	○	○	○	○	○	○	○	○	○	○	○	○	○	○	○	○	○	○	○	○	○	○	○	○	○	○	○	○	○	○	○	
		40694 (170 cm)	○	○	○	○	○	○	○	○	○	○	○	○	○	○	○	○	○	○	○	○	○	○	○	○	○	○	○	○	○	○	○	○	○	○	○	○
Ugello bassa pressione <i>Low pressure nozzle</i>		3251 (2525)	○	○	○	○	○	○	○	○	○	○	○	○	○	○	○	○	○	○	○	○	○	○	○	○	○	○	○	○	○	○	○	○	○	○	○	
Testina doppio ugello <i>Roller nozzle</i>		3025	○	○	○	○	○	○	○	○	○	○	○	○	○	○	○	○	○	○	○	○	○	○	○	○	○	○	○	○	○	○	○	○	○	○	○	
Kit adattatori <i>Adaptors kit</i>		41758	○	○	○	○	○																			○	○	○	○									
Filtro acqua ispezionabile <i>Inspectable water filter</i>		41663 (3 pcs)	S	S	S	S	S	S	S	S	○	○	○	○			○	○	S	S	S	S	S	S	S	S	S	S	S	S	S	S	S	S	S	S		
Kit filtro acqua <i>Water filter kit</i>		41593	○	○	○	○	○	○	○	○	○	○	○	○	○	○	○	○	○	○	○	○	○	○	○	○	○	○	○	○	○	○	○	○	○	○	○	
Kit attacco rapido <i>Click fast kit</i>		41580	○	○	○	○	○	○	○	○	○	○	○	○	○	○	○	○	○	○	○	○	○	○	○	○	○	○	○	○	○	○	○	○	○	○	○	
Kit attacco rapido in ottone <i>Brass click fast kit</i>		40439	○	○	○	○	○	○	○	○	○	○	○	○	○	○	○	○	○	○	○	○	○	○	○	○	○	○	○	○	○	○	○	○	○	○	○	
Kit RLW con tubo <i>Hose reel kit with hose</i>		41766 (10 m)	○	○	○	○																																
Kit RLW senza tubo <i>Hose reel kit w/out hose</i>		42658				○																																
		42509				○	○																															
		42659					○	○																														
		51290							○	○																												
		50272									○	○																										
Avvolgitubo a parete con staffa senza tubo <i>Wall mounted hose reel with bracket w/out hose</i>		50273												○																								
		50264+50270 (AISI304)																○	○																			
Supporto a parete in inox <i>Stainless steel floor stand</i>		50265																○	○																			
Supporto a banco in inox <i>Stainless steel floor stand</i>		50266																○	○																			

PRO HOT

Per utilizzi specifici dove l'acqua calda è un must, le idropultrici Annovi Reverberi con caldaia, soddisfano in pieno le esigenze più estreme di sanificazione e rimozione dello sporco, grazie a prestazioni top di categoria, alla loro tecnologia Made in Italy ed alla loro praticità d'utilizzo.

For specific uses where hot water is a must, Annovi Reverberi high pressure washers with boiler meet the most extreme sanitisation and dirt removal requirements in full, thanks to class-topping performances, Italian technology and very convenient use.



Applicazioni ed indicatori di prestazioni PRO HOT

PRO HOT performance Indicators & Applications

BLUE CLEAN PRO LEVEL

○ LIGHTPRO

Fascia di idropulitrici progettate per utilizzatori esperti che hanno necessità di eseguire lavori di pulizia abbastanza frequenti e che richiedono una abbondante riserva di potenza.

High pressure washer category designed for skilled users tackling cleaning quite frequent jobs operations which need plenty of power in reserve.

● HEAVYPRO

Fascia di idropulitrici progettate per professionisti che hanno necessità di eseguire lavori di pulizia molto frequenti che richiedono le massime prestazioni.

High pressure cleaner category designed for professionals, dealing with cleaning high frequent jobs that need the very highest-performing appliances.

BLUE CLEAN FACTOR



La combinazione ideale tra prestazioni tecniche e configurazione commerciale per poter risolvere al meglio le tue esigenze di pulizia. I prodotti che hanno il BLUE FACTOR sono i migliori, all'interno della loro categoria, per poter pulente, facilità d'utilizzo e prestazioni tecniche. Il mix perfetto per ogni tua esigenza di pulizia.

The ideal combination of technical features and commercial configuration, to deliver the best solution to your cleaning needs. Products with the BLUE FACTOR are best-in-class in cleaning power, ease of use and technical performances. The perfect mix for all your cleaning requirements.

PROFESSIONAL APPLICATIONS

	edilizia construction
	agricoltura zootecnica agriculture zootechny
	artigianato crafts
	car wash
	automotive

Gamma di idropultrici pensate per le sollecitazioni di impiego più prestazionali. Ideali per il settore edile, agricolo e le municipalizzate – coniugano perfettamente il sapere costruttivo Annovi Reverberi con la praticità di un design semplice ma estremamente funzionale.

Range of high pressure washers designed to withstand the most high-performing applications. Ideal for the construction industry, farming and utility companies, they are the ideal blend of Annovi Reverberi's construction know-how and the convenience of simple, stylish, highly functional design.

						
25 Series						
2590		●	●			
35 Series						
3590		●	●			
45 Series						
4590		●	●	●		
56 Series						
5640		●	●			
5670		●	●	●		
58 Series						
5850		●	●	●		
5870		●	●	●		
66 Series						
6640N		●	●	●		
6670N		●	●	●		
69 Series						
6950		●	●	●	●	●
6970N		●	●	●	●	●
78 Series						
7850N		●	●	●	●	●
7870N		●	●	●	●	●
88 Series						
8840		●	●	●	●	●
8860		●	●	●	●	●
8880		●	●	●	●	●
13 Series						
1310		●	●	●	●	●
1320		●	●	●	●	●
1325		●	●	●	●	●
1380		●	●	●	●	●

HPN

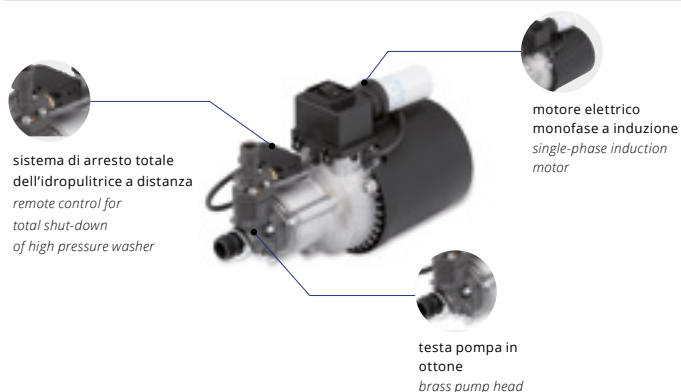

- Pompa a 3 pistoni assiali comandati dal piattello oscillante, testa ottone
- Pistoni in acciaio inox temperato
- Valvola di sicurezza automatica con azzeramento della pressione nella testa pompa
- Motore elettrico monofase a induzione con protezione termica
- Sistema di arresto totale dell'idropulitrice a distanza
- 3 Axial stainless steel pistons wobble-plate pump with brass head
- Tempered stainless steel pistons
- Automatic by-pass valve with pump head pressure discharge
- Single-phase induction motor with thermal protector
- Remote control for total shut-down of high pressure washer



HRM

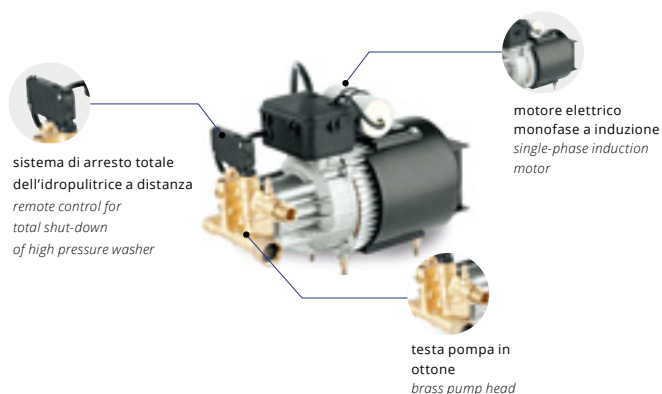

- Pompa a 3 pistoni assiali comandati dal piattello oscillante, testa ottone
- Pistoni in acciaio inox temperato
- Valvola di sicurezza automatica con azzeramento della pressione nella testa pompa
- Motore elettrico monofase a induzione con protezione termica
- Sistema di arresto totale dell'idropulitrice a distanza
- 3 Axial stainless steel pistons wobble-plate pump with brass head
- Tempered stainless steel pistons
- Automatic by-pass valve with pump head pressure discharge
- Single-phase induction motor with thermal protector
- Remote control for total shut-down of high pressure washer



HPV-O

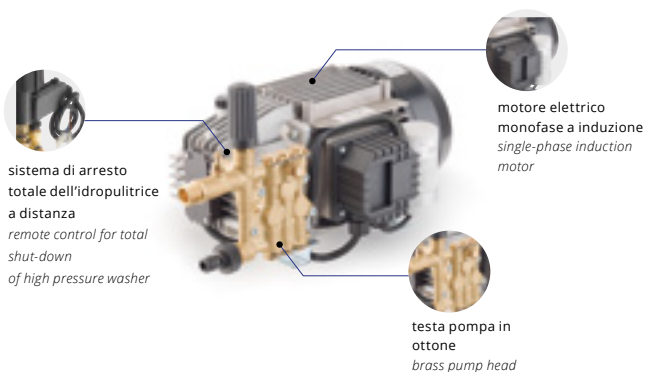

- Pompa a 3 pistoni in ceramica con sistema biella-manovella, testa pompa in alluminio
- Valvola di sicurezza automatica con azzeramento della pressione nella testa pompa
- Motore elettrico monofase a induzione con protezione termica
- Sistema di arresto totale dell'idropulitrice a distanza
- Triplex pump with ceramic pistons and connecting rod system with aluminium pump head
- Automatic by-pass valve with pump head pressure discharge
- Single-phase induction motor with thermal protection
- Remote control for total shut-down of high pressure washer



HRC

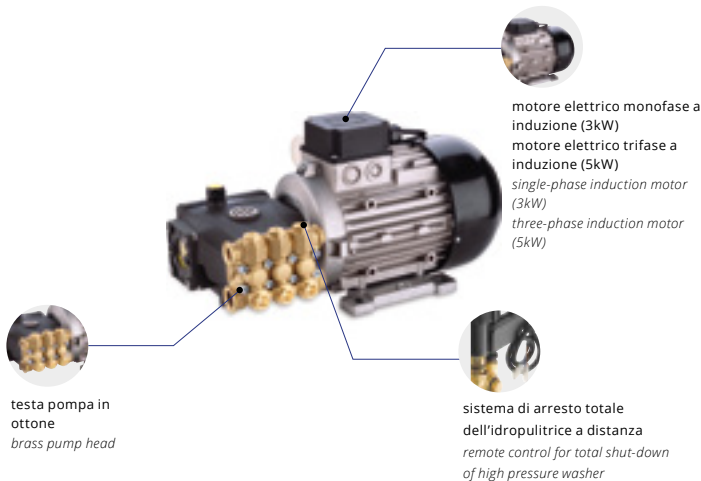

- Pompa a 3 pistoni in ceramica con sistema biella-manovella, testa pompa in ottone
- Valvola di sicurezza automatica con azzeramento della pressione nella testa pompa
- Motore elettrico monofase a induzione con protezione termica (3kW)
- Motore elettrico trifase a induzione con protezione termica (5kW)
- Sistema di arresto totale dell'idropulitrice a distanza

- *Triplex pump with ceramic pistons and connecting rod system with brass pump head*
- *Automatic by-pass valve with pump head pressure discharge*
- *Single-phase induction motor with thermal protection (3kW)*
- *Three-phase induction motor with thermal protection (5kW)*
- *Remote control for total shut-down of high pressure washer*



HRCS

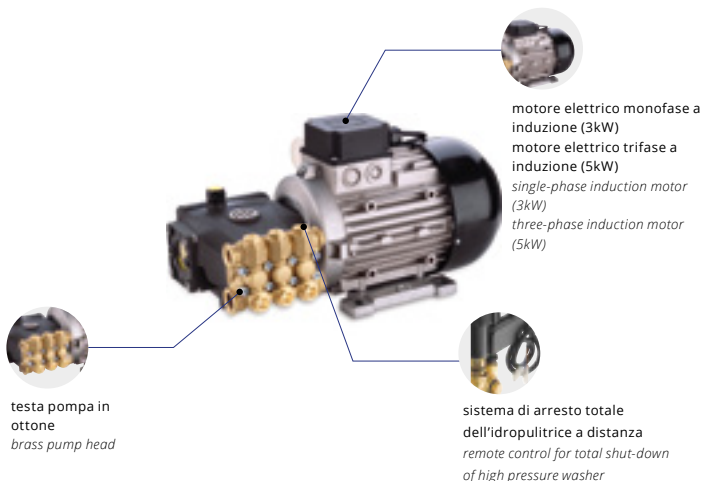

- Pompa a 3 pistoni in ceramica con sistema biella-manovella, testa pompa in ottone
- Valvola di sicurezza automatica con azzeramento della pressione nella testa pompa
- Motore elettrico monofase a induzione con protezione termica (3kW)
- Motore elettrico trifase a induzione con protezione termica (5kW)
- Sistema di arresto totale dell'idropulitrice a distanza

- *Triplex pump with ceramic pistons and connecting rod system with brass pump head*
- *Automatic by-pass valve with pump head pressure discharge*
- *Single-phase induction motor with thermal protection (3kW)*
- *Three-phase induction motor with thermal protection (5kW)*
- *Remote control for total shut-down of high pressure washer*



HRR

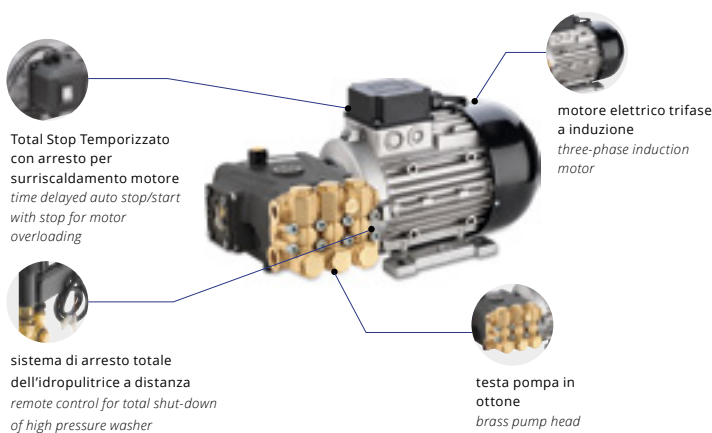

- Pompa a 3 pistoni in ceramica con sistema biella-manovella, testa pompa in ottone
- Valvola di sicurezza automatica con azzeramento della pressione nella testa pompa
- Motore elettrico trifase a induzione con protezione termica
- Sistema di arresto totale dell'idropulitrice a distanza
- Total Stop Temporizzato con arresto per surriscaldamento motore

- *Triplex pump with ceramic pistons and connecting rod system with brass pump head*
- *Automatic by-pass valve with pump head pressure discharge*
- *Three-phase induction motor with thermal protection*
- *Remote control for total shut-down of high pressure washer*
- *Time delayed auto stop/start with stop for motor overloading*



HXW



Total Stop Temporizzato con arresto per surriscaldamento motore
time delayed auto stop/start with stop for motor overloading

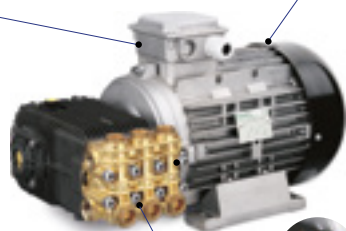

motore elettrico trifase a induzione
three-phase induction motor



testa pompa in ottone
brass pump head



- Pompa a 3 pistoni in ceramica con sistema biella-manovella, testa pompa in ottone
- Valvola di sicurezza automatica con azzeramento della pressione nella testa pompa
- Motore elettrico trifase a induzione con protezione termica
- Total Stop Temporizzato con arresto per surriscaldamento motore
- Triplex pump with ceramic pistons and connecting rod system with brass pump head
- Automatic by-pass valve with pump head pressure discharge
- Three-phase induction motor with thermal protection
- Time delayed auto stop/start with stop for motor overloading

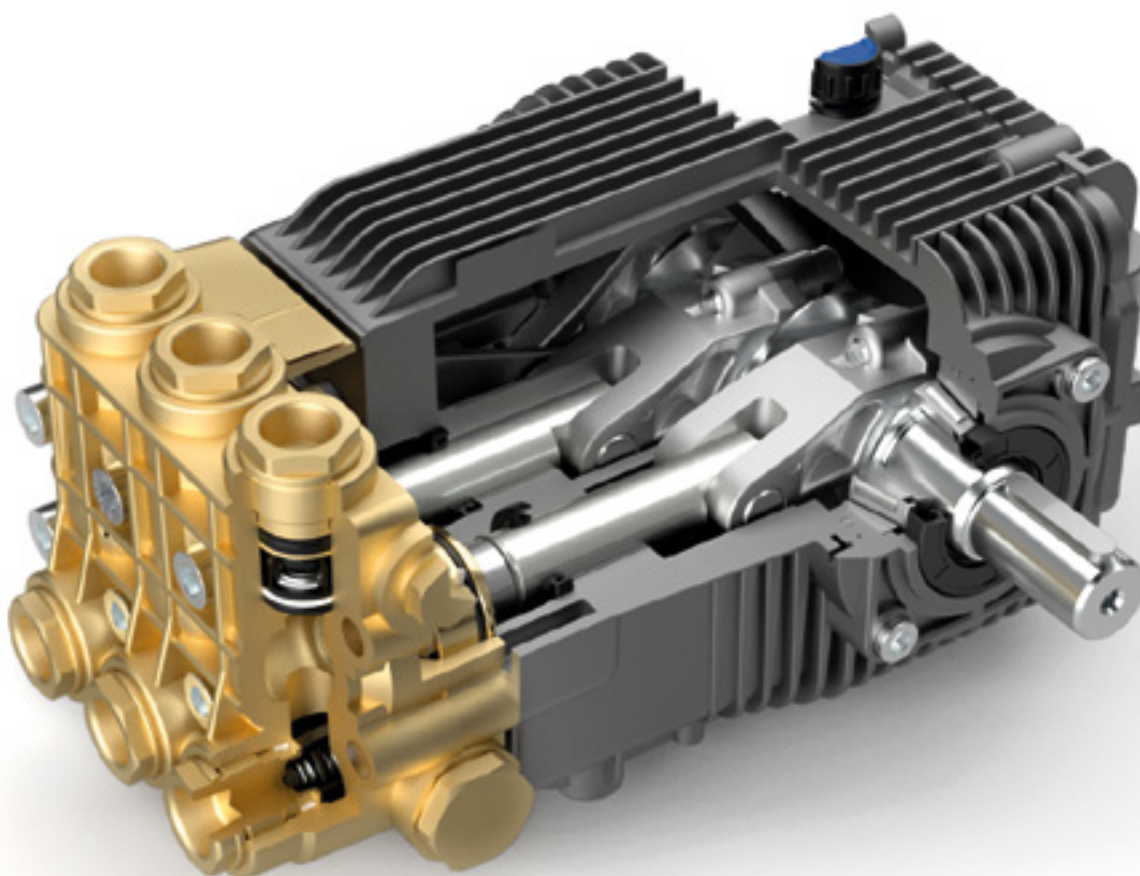

POMPE / PUMPS



	HPN	HRM	HPV-O	HRC	HRCs	HRR	Hxw
SERIE - SERIES	2590	●					
	3590		●				
	4590			●			
	5640		●				
	5670			●			
	5850				●		
	5870					●	
	6640N				●		
	6670N				●		
	6950				●		
	6970N						●
	7850N				●		
	7870N						●
	8840						●
	8860						●
	8880						●
	1310	●					
	1320				●		
	1325				●		
	1380						●









SERIE 25	P 134
SERIE 56	P 136
SERIE 66	P 138
SERIE 69	P 139
SERIE 78	P 140
SERIE 88	P 141
SERIE 13	P 142



25 Series 2590.3590.4590

IDROPULTRICI ALTA PRESSIONE
high pressure washers

OLIGHTPRO



2590 3590 4590

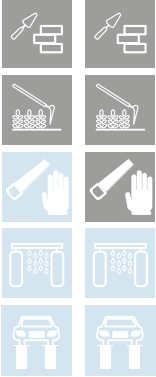

Caratteristiche Generali

- Pompa a 3 pistoni assiali comandati da piattello oscillante (2590, 3590) o con sistema biella-manovella (4590)
- Pistoni in acciaio inox temprato
- Valvola di by-pass automatica con azzeramento della pressione nella testa della pompa
- Motore elettrico a induzione con protezione termica
- Pressostato di sicurezza per spegnimento della caldaia in caso di mancanza acqua
- Caldaia verticale, doppia serpentina e fondo in materiale refrattario
- Serbatoio gasolio 4 l
- Filtro acqua e filtro aspirazione gasolio
- Lunghezza cavo elettrico 5 m

General Features

- 3 Axial stainless steel pistons wobble-plate pump (2590, 3590) or with connecting rod system (4590)
- Tempered stainless steel pistons
- Automatic by-pass valve with pump head pressure discharge
- Single-phase induction electric motor with thermal protector
- With safety pressure switch to shut down the boiler in case of lack of water
- Vertical boiler with double heating coil and refractory compound base
- Fuel tank capacity 4 l
- Water filter and fuel inlet filter
- Electric cable length 5 m

2590	3590	4590
HPN	HRM	HPV-O

2590.3590	4590	2590	3590.4590
WOBBLE PLATE	ROD-CRANK	ALUMINUM	BRASS
INDUCTION	IPX5-S1	TSS® Total Stop SYSTEM	

MOD	COD	MAX		MAX						KG NET
		bar	psi	l/h	gph	kW	rpm	Hz	V	
2590	24424	120	1740	420	111	1,8	2800	50	230~	46
3590	24425	140	2050	480	127	2,4	2800	50	230~	52
4590	24426	150	2200	500	132	2,5	2800	50	230~	52,8

Accessori standard Standard accessories

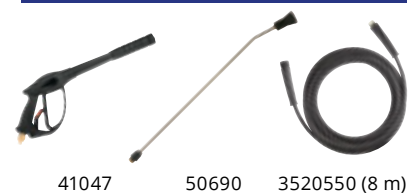

°C Max	Δ°t
90	55
90	55
90	45

3729 (2590.3590/15025)
 3104 (4590/1503)





56 Series 5640.5670

IDROPULTRICI ALTA PRESSIONE
high pressure washers

OLIGHTPRO

5640
5670



Spie: tensione, gasolio, fiamma.
Termostato per regolazione
temperatura acqua
*Warning lights: power on, fuel,
flame. Water temperature control
thermostat*



battistrada in
gomma
rubber wheels



manico ergonomico
ergonomic handle



caldaia in acciaio
Stainless steel boiler



filtro ingresso acqua
ispezionabile
*inspectable water
intake filter*



Caratteristiche Generali

- Pompa a 3 pistoni assiali comandati dal piattello oscillante (5640) o con sistema biella-manovella (5670)
- Valvola di by-pass automatica con azzeramento della pressione nella testa della pompa
- Motore elettrico monofase con protezione termica
- Pressostato di sicurezza per spegnimento della caldaia in caso di mancanza acqua
- Caldaia verticale in acciaio inox, con sistema di raffreddamento bruciatore a chiocciola azionata da motore elettrico indipendente, doppia serpentina e fondo in cemento refrattario
- Scheda di ritardo per spegnimento caldaia
- Regolazione pressione
- Serbatoio gasolio 8 l, con tappo di scarico
- Termostato
- Aspirazione detergente incorporata
- Filtro acqua e filtro aspirazione gasolio
- Lunghezza cavo elettrico 5 m

General Features

- 3 Axial stainless steel pistons wobble-plate pump (5640) or with connecting rod system (5670)
- Automatic by-pass valve with pump head pressure discharge
- Heavy-duty mono-phase motor with thermal protector
- With safety pressure switch to shut down the boiler in case of lack of water
- Stainless steel vertical boiler with coil burner cooling function driven by independent motor, double coil and refractory cement bottom
- Heating boiler shut-down delay circuit
- Pressure adjustment built-in
- Fuel tank with drain plug (8 l)
- Thermostat
- Built-in detergent suction
- Water filter and fuel inlet filter
- Electric cable length 5 m

5640 5670

HRM

HPV-O

5640

5670



WOBBLE PLATE



ROD-CRANK



BRASS



INDUCTION



IPX5-S1



TSS®
Total Stop
SYSTEM

MOD	COD	MAX		MAX						
		bar	psi	l/h	gph	kW	rpm	Hz	V	kg
5640	25670	140	2000	480	127	2,4	2800	50	230~	79
5670	25671	150	2200	500	132	2,5	2800	50	230~	80

Accessori standard Standard accessories



41047

40826
(57 cm)

3164450 (8 m)

3729 (5640/15025)
3104 (5670/1503)



°C Max Δ°t

90 55

90 45



HEAVYPRO



Spie: tensione, gasolio, fiamma.
Termostato per regolazione temperatura acqua
Warning lights: power on, fuel, flame. Water temperature control thermostat



battistrada in gomma
rubber wheels



manico ergonomico
ergonomic handle



caldaia in acciaio
Stainless steel boiler



filtro ingresso acqua ispezionabile
inspectable water intake filter



Caratteristiche Generali

- Pompa a pistoni con sistema biella-manovella ad elevate prestazioni
- Valvola di by-pass automatica con azzeramento della pressione nella testa della pompa
- Pressostato di sicurezza per spegnimento della caldaia in caso di mancanza acqua
- Caldaia verticale in acciaio inox, con sistema di raffreddamento bruciatore a chiocciola azionata da motore elettrico indipendente, doppia serpentina e fondo in cemento refrattario
- Scheda di ritardo per spegnimento caldaia
- Regolazione pressione
- Serbatoio gasolio 8 l, con tappo di scarico
- Termostato
- Aspirazione detergente incorporata
- Filtro acqua e filtro aspirazione gasolio
- Lunghezza cavo elettrico 5 m

General Features

- High performance piston pump with connecting rod system
- Automatic by-pass valve with pump head pressure discharge
- With safety pressure switch to shut down the boiler in case of lack of water
- Stainless steel vertical boiler with coil burner cooling function driven by independent motor, double coil and refractory cement bottom
- Heating boiler shut-down delay circuit
- Pressure adjustment built-in
- Fuel tank with drain plug (8 l)
- Thermostat
- Built-in detergent suction
- Water filter and fuel inlet filter
- Electric cable length 5 m

5850

5870

HRC

HRCS



INDUCTION



ROD-CRANK



BRASS



IPX5-S1



TSS®
Total Stop SYSTEM

MOD	COD	MAX		MAX						
		bar	psi	l/h	gph	kW	rpm	Hz	V	kg
5850	25672	130	1900	600	159	3	1450	50~	230	83
5870	25673	150	2200	900	238	3	2800	50 3~	400	84

Accessori standard Standard accessories



41047 (5850)

40826 (57 cm)

3082 (5850/1504)
3095 (5870/15055)

41847 (5870)

3164450 (5850/8 m)
3160160 (5870/10 m)



°C Max	Δt
150	55
150	70



66 Series 6640N.6670N

IDROPULITRICI ALTA PRESSIONE
high pressure washers

HEAVYPRO



caldaia in acciaio
Stainless steel boiler



filtro ingresso acqua
ispezionabile
inspectable water
intake filter



battistrada in gomma
rubber wheels



manico ergonomico
ergonomic handle



Termostato (di serie)
Thermostat (equipped
with)



ruota anteriore
pivottante
front castor wheel

Caratteristiche Generali

- Pompa a 3 pistoni in ceramica con sistema biella-manovella
- Valvola di by-pass automatica con azzeramento della pressione nella testa della pompa
- Motore elettrico con protezione termica
- Pressostato di sicurezza per spegnimento della caldaia in caso di mancanza acqua
- Caldaia verticale in acciaio verniciato, con sistema di raffreddamento bruciatore a chiocciola azionata da motore elettrico indipendente, doppia serpentina e fondo in cemento refrattario
- Scheda di ritardo per spegnimento caldaia
- Regolazione pressione
- Serbatoio gasolio 22 l, con tappo di scarico
- Termostato
- Aspirazione detergente incorporata
- Serbatoio detergente 3,5/4 l incorporato
- Filtro acqua e filtro aspirazione gasolio
- Lunghezza cavo elettrico 5 m

General Features

- Triplex pump with ceramic pistons and connecting rod system
- Automatic by-pass valve with pump head pressure discharge
- Heavy-duty motor with thermal protector
- With safety pressure switch to shut down the boiler in case of lack of water
- Coated steel vertical boiler with coil burner cooling function driven by independent electric motor, double coil and refractory cement bottom
- Heating boiler shut-down delay circuit
- Pressure adjustment built-in
- Fuel tank with drain plug (22 l)
- Thermostat
- Built-in detergent suction
- Built-in detergent tank capacity 3.5/4 l
- Water filter and fuel inlet filter
- Electric cable length 5 m

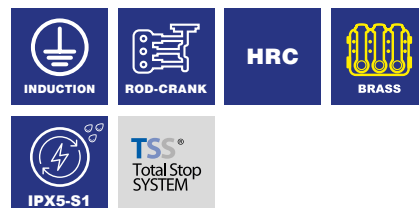

MOD	COD	MAX	MAX		NET					
		bar	psi	l/h	gph	kW	rpm	Hz	V	kg
6640N	25275	130	1900	600	159	3	1450	50	230~	82
6670N	25288	170	2500	780	206	5	1450	50	400 3~	85



°C Max	Δt
150	55
150	45

Accessori standard Standard accessories





HEAVYPRO



manico ergonomico
ergonomic handle



battistrada in gomma
rubber wheels



spie: tensione, gasolio, fiamma
termostato per regolazione temperatura acqua
warning lights: power on, fuel, flame
water temperature control thermostat



caldaia in acciaio
Stainless steel boiler



filtro ingresso acqua
ispezionabile
inspectable water intake filter

Caratteristiche Generali

- Pompa a 3 pistoni in ceramica con sistema biella-manovella
- Valvola di by-pass automatica con azzeramento della pressione nella testa della pompa
- Motore elettrico trifase con protezione termica
- Sistema di arresto totale dell'idropulitrice a distanza
- Pressostato di sicurezza per spegnimento della caldaia in caso di mancanza acqua
- Caldaia verticale in acciaio inox, con sistema di raffreddamento bruciatore a chiocciola azionata da motore elettrico indipendente, doppia serpentina e fondo in cemento refrattario
- Scheda di ritardo per spegnimento caldaia
- Regolazione pressione
- Serbatoio gasolio 14 l, con tappo di scarico
- Termostato
- Aspirazione detergente incorporata
- Serbatoio detergente 6 l incorporato
- Filtro acqua e filtro aspirazione gasolio
- Lunghezza cavo elettrico 5 m

General Features

- Triplex pump with ceramic pistons and connecting rod system
- Automatic by-pass valve with pump head pressure discharge
- Heavy-duty three-phase motor with thermal protector
- Remote control for total shut-down of high pressure cleaner
- With safety pressure switch to shut down the boiler in case of lack of water
- Stainless steel vertical boiler with coil burner cooling function driven by independent motor, double coil and refractory cement bottom
- Heating boiler shut-down delay circuit
- Pressure adjustment built-in
- Fuel tank with drain plug (14 l)
- Thermostat
- Built-in detergent suction
- Built-in detergent tank capacity 6 l
- Water filter and fuel inlet filter
- Electric cable length 5 m

	6950	6970N
	HRC	HRR
	TSS® Total Stop SYSTEM	

MOD	COD	MAX		MAX					KG NET	
		bar	psi	l/h	gph	kW	rpm	Hz	V	kg
6950	24103	150	2200	900	238	5	1450	50	400 3~	94
6970N	25276	200	2900	900	238	7,4	1450	50	400 3~	98



°C Max	Δ°t
150	70
150	60

Accessori standard Standard accessories





78 Series 7850N.7870N

IDROPULTRICI ALTA PRESSIONE
high pressure washers

HEAVYPRO



manico ergonomico
ergonomic handle



battistrada in gomma
rubber wheels



spie: tensione, gasolio, fiamma
termostato per regolazione
temperatura acqua
warning lights: power on, fuel, flame
water temperature control thermostat

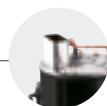

caldaia in acciaio
Stainless steel boiler



filtro ingresso acqua
ispezionabile
inspectable water intake filter



Caratteristiche Generali

- Pompa a 3 pistoni in ceramica con sistema biella-manovella
- Valvola di by-pass automatica con azzeramento della pressione nella testa della pompa
- Motore elettrico trifase con protezione termica
- Sistema di arresto totale dell'idropulitrice a distanza
- Pressostato di sicurezza per spegnimento della caldaia in caso di mancanza acqua
- Caldaia verticale in acciaio inox, con sistema di raffreddamento bruciatore a chiodi azionata da motore elettrico indipendente, doppia serpentina e fondo in cemento refrattario
- Scheda micropertite con segnalatore acustico
- Scheda di ritardo per spegnimento caldaia
- Regolazione pressione
- Serbatoio gasolio 15 l, con tappo di scarico
- Termostato
- Aspirazione detergente incorporata
- Serbatoio detergente 4/5 l incorporato
- Filtro acqua e filtro aspirazione gasolio
- Lunghezza cavo elettrico 5 m

General Features

- Triplex pump with ceramic pistons and connecting rod system
- Automatic by-pass valve with pump head pressure discharge
- Heavy-duty three-phase motor with thermal protector
- Remote control for total shut-down of high pressure cleaner
- With safety pressure switch to shut down the boiler in case of lack of water
- Stainless steel vertical boiler with coil burner cooling function driven by independent motor, double coil and refractory cement bottom
- Minor leak detector PCB with buzzer
- Heating boiler shut-down delay circuit
- Pressure adjustment built-in
- Fuel tank with drain plug (15 l)
- Thermostat
- Built-in detergent suction
- Built-in detergent tank capacity 4/5 l
- Water filter and fuel inlet filter
- Electric cable length 5 m

	7850N	7870N
	HRC	HRR
	TSS [®] Total Stop SYSTEM	
		BRASS

MOD	COD	MAX		MAX					KG NET	
		bar	psi	l/h	gph	kW	rpm	Hz	V	kg
7850N	25277	150	2200	900	238	5	1450	50	400 3~	94
7870N	25278	200	2900	900	238	7,4	1450	50	400 3~	98



°C Max	Δt
150	70
150	60

Accessori standard Standard accessories





HEAVYPRO



Caratteristiche Generali

- Pompa a 3 pistoni in ceramica con sistema biella-manovella
- Valvola di by-pass automatica con azzeramento della pressione nella testa della pompa
- Motore elettrico trifase con protezione termica
- Sistema di arresto totale dell'idropulitrice a distanza
- Pressostato di sicurezza per spegnimento della caldaia in caso di mancanza acqua
- Caldaia verticale in acciaio inox, con sistema di raffreddamento bruciatore a chiocciola azionata da motore elettrico indipendente, doppia serpentina e fondo in cemento refrattario
- Scheda micropertdite con segnalatore acustico
- Scheda di ritardo per spegnimento caldaia
- Regolazione pressione
- Serbatoio gasolio 24 l, con tappo di scarico
- Termostato
- Aspirazione detergente incorporata
- Serbatoio detergente 8 l incorporato
- Filtro acqua e filtro aspirazione gasolio
- Lunghezza cavo elettrico 10 m

General Features

- Triplex pump with ceramic pistons and connecting rod system
- Automatic by-pass valve with pump head pressure discharge
- Heavy-duty three-phase motor with thermal protector
- Remote control for total shut-down of high pressure cleaner
- With safety pressure switch to shut down the boiler in case of lack of water
- Stainless steel vertical boiler with coil burner cooling function driven by independent motor, double coil and refractory cement bottom
- Minor leak detector PCB with buzzer
- Heating boiler shut-down delay circuit
- Pressure adjustment built-in
- Fuel tank with drain plug (24 l)
- Thermostat
- Built-in detergent suction
- Built-in detergent tank capacity 8 l
- Water filter and fuel inlet filter
- Electric cable length 10 m

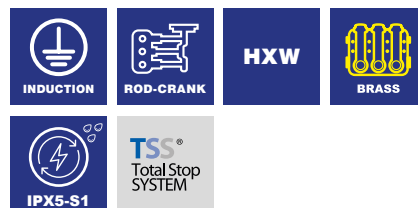

MOD	COD	MAX	MAX							KG NET
		bar	psi	l/h	gph	kW	rpm	Hz	V	kg
8840	22913	150	2200	1260	333	7,4	1450	50	400 3~	135
8860	22914	200	2900	1260	333	9,3	1450	50	400 3~	135
8880	22915	250	3600	900	238	9,3	1450	50	400 3~	135



°C Max	Δ°t
150	55
150	55
150	60

Accessori standard Standard accessories





13 Series 1310.1320.1325

IDROPULTRICI ALTA PRESSIONE
high pressure washers

HEAVYPRO



quadro comandi
bassa tensione
low voltage
control panel



filtro ingresso acqua ispezionabile
inspectable water intake filter



caldaia in acciaio
Stainless steel boiler



porta accessori
built-in accessories
holder



battistrada in
gomma
rubber wheels

Caratteristiche Generali

- Struttura robusta con cofano in acciaio inox (AISI 430)
- Pompa a 3 pistoni in ceramica con sistema biella-manovella
- Testa pompa in ottone
- Valvola di by-pass automatica
- Motore elettrico monofase
- Protezione motore magnetotermica
- Total Stop Temporizzato
- Arresto per microperdite
- Arresto dopo 1 ora di Total Stop
- Arresto per mancanza d'acqua
- Arresto per surriscaldamento motore
- Segnalazione d'errore tramite spia intermittente
- Termostato 150°C
- Regolazione pressione
- Quadro comandi a bassa tensione
- Spie presenza corrente, gasolio e TST
- Quadro comandi in inox (AISI 430)
- 3 pressostati a 24 V
- Caldaia inox (AISI 430)
- Aspirazione detergente incorporata, regolabile
- Serbatoio gasolio 24 l
- Lunghezza cavo elettrico 5 m

General Features

- Heavy-duty frame with stainless steel cover (AISI 430)
- Triplex pump with ceramic pistons and connecting rod system
- Brass pump head
- Automatic by-pass valve
- Heavy-duty one-phase motor
- Magnetothermal motor overload cutout
- Time delayed auto stop/start
- Stop for leak detention
- Stop after 1 hour of total stop
- Stop for lack of water
- Stop for motor overloading
- System error warning light
- Thermostat 150°C
- Pressure adjustment
- Low voltage control panel
- Power on, fuel level and TST lights
- Stainless steel control panel
- 3 Pressure switches at 24V
- Stainless steel boiler (AISI 430)
- Integral detergent suction with setting adjustment
- Fuel tank 24 l
- Electric cable length 5 m

1310 1320.1325

HPV-O

HRC



INDUCTION



ROD-CRANK



BRASS



IPX5-S1



TST®
Total Stop
SYSTEM
TIMED

MOD	COD	MAX	MAX		NET					
		bar	psi	l/h	gph	kW	rpm	Hz	V	kg
1310	24894	150	2200	500	133	2,5	2800	50	230~	105
1320	25273	130	1900	600	159	3	1450	50	230~	110
1325	25274	150	2200	900	238	5	2800	50	400 3~	110



°C Max Δt

150 65

150 55

150 60

Accessori standard Standard accessories



41047

40826
(57 cm)

3104 (1310/1503)
3082 (1320.1504)
3095 (1325.15055)



3164470 (1310/8 m)
3160160 (1320.1325/10 m)



HEAVYPRO



quadro comandi
bassa tensione
low voltage
control panel



filtro ingresso acqua ispezionabile
inspectable water intake filter



caldaia in acciaio
Stainless steel boiler



porta accessori
built-in accessories
holder



battistrada in
gomma
rubber wheels

Caratteristiche Generali

- Struttura robusta con cofano in acciaio inox (AISI 430)
- Pompa a 3 pistoni in ceramica con sistema biella-manovella
- Valvola di by-pass automatica
- Motore elettrico trifase
- Protezione motore magnetotermica
- Arresto per microperdite
- Arresto dopo 1 ora di Total Stop
- Arresto per mancanza d'acqua
- Arresto per surriscaldamento motore
- Segnalazione d'errore tramite spia intermittente
- Termostato 150°C
- Regolazione pressione
- Quadro comandi a bassa tensione
- Spie presenza corrente, gasolio e TST
- Quadro comandi in inox (AISI 430)
- 3 pressostati a 24 V
- Caldaia inox (AISI 430)
- Aspirazione detergente incorporata, regolabile
- Serbatoio gasolio 24 l
- Lunghezza cavo elettrico 5 m

General Features

- Heavy-duty frame with stainless steel cover (AISI 430)
- Triplex pump with ceramic pistons and connecting rod system
- Automatic by-pass valve
- Heavy-duty three-phase motor
- Magnetothermal motor overload cutout
- Time delayed auto stop/start
- Stop for leak detention
- Stop after 1 hour of total stop
- Stop for lack of water
- Stop for motor overloading
- System error warning light
- Thermostat 150°C
- Pressure adjustment
- Low voltage control panel
- Power on, fuel level and TST lights
- Stainless steel control panel
- 3 Pressure switches at 24V
- Stainless steel boiler (AISI 430)
- Integral detergent suction with setting adjustment
- Fuel tank 24 l
- Electric cable length 5 m

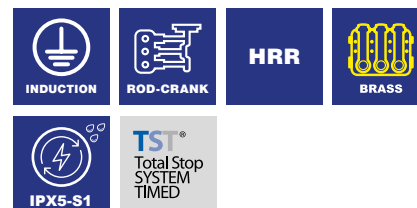

MOD	COD	MAX	MAX							KG NET
		bar	psi	l/h	gph	kW	rpm	Hz	V	kg
1380	25284	200	2900	900	238	7,4	1450	50	400 3~	150



°C Max	Δ°t
150	60

Accessori standard Standard accessories















ACCESSORI

Accessories







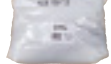







			25 Series	35 Series	45 Series	56 Series	58 Series	66 Series	69 Series	78 Series	88 Series	13 Series												
			2590	3590	4590	5640	5670	5850	5870	6640N	6670N	6950	6970N	7850N	7870	8840	8860	8880	1310	1320	1325	1380		
Pistola Trigger gun		41047	S	S	S	S	S	S											S	S	S			
		41089								S	S	S	S	S	S	S	S	S				S		
		41847						S																
Lancia con testina fissa senza ugello Lance with fixed head w/out nozzle		46221 (56 cm)	S	S	S												S							
Lancia con testina alta/bassa press. senza ugello Lance with high/low pressure head w/out nozzle		40826 (57 cm)				S	S	S	S	S	S	S	S	S	S	S	S		S	S	S	S		
Ugelli Wash nozzles 1/4 MEG		3729 (15025)	S	S		S																		
		3104 (1503)			S		S													S				
		3082 (1504)						S	S									S		S				
		3086 (15045)								S	S	S											S	
		3083 (1505)									S	S												
		3095 (15055)							S													S		
		3084 (1506)																S						
		3157 (1508)											S											
		Lancia getto rotante PRO Rotary lance PRO		40898 (56 cm)	O	O		O																
41050 (56 cm)					O		O														O			
40964 (56 cm)								O	O										O		O			
40803 (56 cm)										O	O		O										O	
40965 (56 cm)									O									O				O		
40966 (56 cm)											O	O												
40969 (56 cm)																	O	O						
Tubo AP Hose HP				3520550 (8 m) Reinforced	S	S	S																	
				3164450 (8 m) Reinforced				S	S	S														
		3164470 (8 m) Reinforced																		S				
		3160160 (10 m) Reinforced							S	S	S	S	S	S	S	S					S	S	S	
		3160170 (10 m) Reinforced															S	S	S					
Prolunga tubo AP Reinforced extension HP hose		40641 (15 m)	O	O	O	O	O	O												O				
		40106 (15 m)							O	O	O	O	O	O	O	O	O	O			O	O	O	
Kit schiumogeno Foam lance bottle *		40320	O	O	O																			

(* Utilizzare solo con acqua fredda
(*) Use cold water only

			25 Series		35 Series		45 Series		56 Series		58 Series		66 Series		69 Series		78 Series		88 Series		13 Series		
			2590	3590	4590	5640	5670	5850	5870	6640N	6670N	6950	6970N	7850N	7870	8840	8860	8880	1310	1320	1325	1380	
Kit schiumogeno alta pressione High pressure foam lance bottle *		46195	○	○	○	○	○	○	○	○	○	○	○	○	○	○	○	○	○	○	○	○	○
		1272520 (8 m)	○	○	○	○	○	○	○	○	○	○	○	○	○	○	○	○	○	○	○	○	○
Kit pulizia tubazioni Pipe drain kit		1272530 (16 m)	○	○	○	○	○	○	○	○	○	○	○	○	○	○	○	○	○	○	○	○	○
		46365 (10 m) *																○					
		46367 (16 m) *																○					
Spazzola fissa Fixed brush *		41577	○	○	○	○	○																
		41578	○	○	○	○	○																
Spazzola rotante Rotary brush *		46370								○	○	○	○	○	○	○	○	○		○	○	○	○
		46371																	○				
Lavapavimenti con serbatoio detergente d. 30 cm Patio cleaner with detergent tank d. 30 cm		41687	○	○	○	○	○																
Lavapavimenti d. 30 cm Patio cleaner d. 30 cm		43659	○	○	○	○	○																
Lavapavimenti PRO con regolazione Patio cleaner PRO with pressure adjustment *		46368	○	○	○	○	○														○		
		46369								○		○			○		○			○		○	○
Kit lancia sabbiante PRO Sand blasting lance PRO *		41591 (50 cm)	○	○	○	○	○															○	
		41762 (50 cm)								○		○			○		○			○		○	○
		41763 (50 cm)								○		○	○		○		○	○		○		○	○
Sabbia calibrata e filtrata Calibrated filtered sand		3207 (5 kg)	○	○	○	○	○	○	○	○	○	○	○	○	○	○	○	○	○	○	○	○	○
		41770 (25 kg)	○	○	○	○	○	○	○	○	○	○	○	○	○	○	○	○	○	○	○	○	○

(* Utilizzare solo con acqua fredda
(*) Use cold water only

		25 Series	35 Series	45 Series	56 Series	58 Series	66 Series	69 Series	78 Series	88 Series	13 Series					
		2590	3590	4590	5640	5850	6640N	6950	7850N	8840	8860	8880	1310	1320	1325	1380
Kit aspirazione acqua <i>Water suction kit *</i>		41592	<input type="checkbox"/>	<input type="checkbox"/>	<input type="checkbox"/>	<input type="checkbox"/>	<input type="checkbox"/>	<input type="checkbox"/>	<input type="checkbox"/>	<input type="checkbox"/>	<input type="checkbox"/>	<input type="checkbox"/>	<input type="checkbox"/>	<input type="checkbox"/>	<input type="checkbox"/>	<input type="checkbox"/>
		46374 (15025)	<input type="checkbox"/>	<input type="checkbox"/>	<input type="checkbox"/>											
Kit lancia sottoscocca con ugello <i>Underbody lance with nozzle *</i>		41590 (1503 - 80 cm)		<input type="checkbox"/>	<input type="checkbox"/>								<input type="checkbox"/>			
		41751 (1504 - 80 cm)				<input type="checkbox"/>	<input type="checkbox"/>					<input type="checkbox"/>		<input type="checkbox"/>		
		46372 (15045 - 80 cm)						<input type="checkbox"/>	<input type="checkbox"/>	<input type="checkbox"/>						
		41753 (1505 - 80 cm)							<input type="checkbox"/>	<input type="checkbox"/>						
		46373 (1506 - 80 cm)					<input type="checkbox"/>				<input type="checkbox"/>				<input type="checkbox"/>	
		41754 (1508 - 80 cm)								<input type="checkbox"/>						
Lancia senza ugello <i>Lance w/out nozzle</i>		40652 (90 cm)	<input type="checkbox"/>	<input type="checkbox"/>	<input type="checkbox"/>	<input type="checkbox"/>	<input type="checkbox"/>	<input type="checkbox"/>	<input type="checkbox"/>	<input type="checkbox"/>	<input type="checkbox"/>	<input type="checkbox"/>	<input type="checkbox"/>	<input type="checkbox"/>	<input type="checkbox"/>	<input type="checkbox"/>
		40653 (120 cm)	<input type="checkbox"/>	<input type="checkbox"/>	<input type="checkbox"/>	<input type="checkbox"/>	<input type="checkbox"/>	<input type="checkbox"/>	<input type="checkbox"/>	<input type="checkbox"/>	<input type="checkbox"/>	<input type="checkbox"/>	<input type="checkbox"/>	<input type="checkbox"/>	<input type="checkbox"/>	<input type="checkbox"/>
		40654 (150 cm)	<input type="checkbox"/>	<input type="checkbox"/>	<input type="checkbox"/>	<input type="checkbox"/>	<input type="checkbox"/>	<input type="checkbox"/>	<input type="checkbox"/>	<input type="checkbox"/>	<input type="checkbox"/>	<input type="checkbox"/>	<input type="checkbox"/>	<input type="checkbox"/>	<input type="checkbox"/>	<input type="checkbox"/>
		40694 (170 cm)	<input type="checkbox"/>	<input type="checkbox"/>	<input type="checkbox"/>	<input type="checkbox"/>	<input type="checkbox"/>	<input type="checkbox"/>	<input type="checkbox"/>	<input type="checkbox"/>	<input type="checkbox"/>	<input type="checkbox"/>	<input type="checkbox"/>	<input type="checkbox"/>	<input type="checkbox"/>	<input type="checkbox"/>
		40695 (200 cm)	<input type="checkbox"/>	<input type="checkbox"/>	<input type="checkbox"/>	<input type="checkbox"/>	<input type="checkbox"/>	<input type="checkbox"/>	<input type="checkbox"/>	<input type="checkbox"/>	<input type="checkbox"/>	<input type="checkbox"/>	<input type="checkbox"/>	<input type="checkbox"/>	<input type="checkbox"/>	<input type="checkbox"/>
Lancia doppia <i>Double lance</i>		3160620 (66 cm)	<input type="checkbox"/>	<input type="checkbox"/>	<input type="checkbox"/>	<input type="checkbox"/>	<input type="checkbox"/>	<input type="checkbox"/>	<input type="checkbox"/>	<input type="checkbox"/>	<input type="checkbox"/>	<input type="checkbox"/>	<input type="checkbox"/>	<input type="checkbox"/>	<input type="checkbox"/>	<input type="checkbox"/>
Ugello bassa pressione <i>Low pressure nozzle</i>		3251 (2525)	<input type="checkbox"/>	<input type="checkbox"/>	<input type="checkbox"/>	<input type="checkbox"/>	<input type="checkbox"/>	<input type="checkbox"/>	<input type="checkbox"/>	<input type="checkbox"/>	<input type="checkbox"/>	<input type="checkbox"/>	<input type="checkbox"/>	<input type="checkbox"/>	<input type="checkbox"/>	<input type="checkbox"/>
Testina doppio ugello <i>Roller nozzle</i>		3025	<input type="checkbox"/>	<input type="checkbox"/>	<input type="checkbox"/>	<input type="checkbox"/>	<input type="checkbox"/>	<input type="checkbox"/>	<input type="checkbox"/>	<input type="checkbox"/>	<input type="checkbox"/>	<input type="checkbox"/>	<input type="checkbox"/>	<input type="checkbox"/>	<input type="checkbox"/>	<input type="checkbox"/>
Ugello a vapore <i>Steam nozzle</i>		50250	<input type="checkbox"/>	<input type="checkbox"/>	<input type="checkbox"/>	<input type="checkbox"/>	<input type="checkbox"/>	<input type="checkbox"/>	<input type="checkbox"/>	<input type="checkbox"/>	<input type="checkbox"/>	<input type="checkbox"/>	<input type="checkbox"/>	<input type="checkbox"/>	<input type="checkbox"/>	<input type="checkbox"/>
Kit filtro acqua <i>Water filter kit</i>		46186	<input type="checkbox"/>	<input type="checkbox"/>	<input type="checkbox"/>	<input type="checkbox"/>	<input type="checkbox"/>	<input type="checkbox"/>	<input type="checkbox"/>	<input type="checkbox"/>	<input type="checkbox"/>	<input type="checkbox"/>	<input type="checkbox"/>	<input type="checkbox"/>	<input type="checkbox"/>	<input type="checkbox"/>
Kit filtro ai sali polifosfati <i>Polyphosphate salt filter</i>		51094	<input type="checkbox"/>	<input type="checkbox"/>	<input type="checkbox"/>	<input type="checkbox"/>	<input type="checkbox"/>	<input type="checkbox"/>	<input type="checkbox"/>	<input type="checkbox"/>	<input type="checkbox"/>	<input type="checkbox"/>	<input type="checkbox"/>	<input type="checkbox"/>	<input type="checkbox"/>	<input type="checkbox"/>
Kit attacco rapido <i>Click fast kit</i>		46187	<input type="checkbox"/>	<input type="checkbox"/>	<input type="checkbox"/>	<input type="checkbox"/>	<input type="checkbox"/>	<input type="checkbox"/>	<input type="checkbox"/>	<input type="checkbox"/>	<input type="checkbox"/>	<input type="checkbox"/>	<input type="checkbox"/>	<input type="checkbox"/>	<input type="checkbox"/>	<input type="checkbox"/>
Kit attacco rapido ottone <i>Brass click fast kit</i>		40439	<input type="checkbox"/>	<input type="checkbox"/>	<input type="checkbox"/>	<input type="checkbox"/>	<input type="checkbox"/>	<input type="checkbox"/>	<input type="checkbox"/>	<input type="checkbox"/>	<input type="checkbox"/>	<input type="checkbox"/>	<input type="checkbox"/>	<input type="checkbox"/>	<input type="checkbox"/>	<input type="checkbox"/>
Kit RLW senza tubo <i>Hose reel kit w/out hose</i>		42660	<input type="checkbox"/>	<input type="checkbox"/>	<input type="checkbox"/>											
		40839					<input type="checkbox"/>	<input type="checkbox"/>								
		40840						<input type="checkbox"/>	<input type="checkbox"/>	<input type="checkbox"/>	<input type="checkbox"/>	<input type="checkbox"/>				



CLEANING **DIVISION**

VACUUM CLEANERS HOME

Compatti ma estremamente potenti e versatili. Studiati anche per la pulizia di piccoli spazi, gli aspiratori multiuso AR BLUE CLEAN sono la soluzione ideale per diversi tipi di sporco, sia esso solido e liquido. Rumorosità controllata e accessori pratici sono gli ingredienti perfetti per prenderti cura degli spazi a te più cari con estrema praticità.

Compact but extremely powerful and versatile. Designed for cleaning even small spaces, AR BLUE CLEAN multi-purpose vacuum cleaners are the ideal solution for different types of both solid and liquid dirt. Controlled noise levels and handy accessories are the perfect ingredients for taking care of the spaces you love with the greatest of ease.



Applicazioni ed indicatori di prestazioni Aspirapolveri Home

Vacuum Cleaners Home performance Indicators & Applications

BLUE CLEAN LEVEL

BLUE CLEAN LEVEL A
Frequenza utilizzo: **occasionale**
Superficie mq: **piccole superfici**
Intensità sporco: **sporco superficiale**
*Frequency of use: occasional
Surface m²: small surfaces
Dirt intensity: superficial dirt*

BLUE CLEAN LEVEL B
Frequenza utilizzo: **occasionale**
Superficie mq: **piccole/medie superfici 20/40 m²**
Intensità sporco: **pulizia profonda di sporco superficiale**
*Frequency of use: occasional
Surface m²: small/medium surfaces 20/40 m²
Dirt intensity: in-depth removal of superficial dirt*

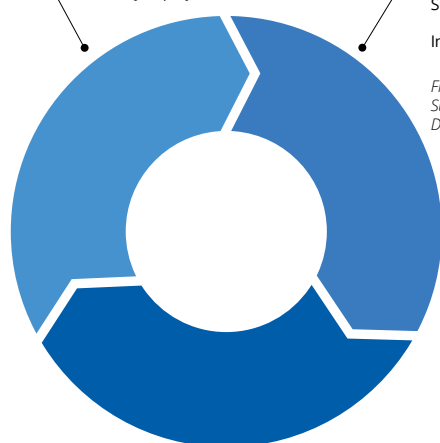

BLUE CLEAN LEVEL C
Frequenza utilizzo: **quasi frequente**
Superficie mq: **medie superfici 40/60 m²**
Intensità sporco: **sporco resistente**
*Frequency of use: almost frequent
Surface m²: medium surfaces 40/60 m²
Dirt intensity: stubborn dirt*

BLUE CLEAN LEVEL ti guida nella scelta del prodotto migliore, in base ad ogni esigenza di pulizia, affiancando ad ogni idropulitrice o aspiratore un'icona di livello lavaggio, insieme con le applicazioni. Ogni prodotto ha le sue caratteristiche tecniche ma anche estetiche-funzionali per soddisfare specifiche necessità del cliente, come la facilità d'uso, la compattezza, l'ergonomia, il peso, la rumorosità e la manovrabilità. Grazie al Blue Clean Level suggeriamo ad ogni cliente la combinazione migliore: è per questo che i prodotti ARBC fanno la differenza.

BLUE CLEAN LEVEL guides you in the choice of the best products for all cleaning needs, by placing a cleaning level icon next to every high pressure washer or vacuum cleaner, together with its applications. Every product has its own technical, stylistic and functional characteristics, to satisfy specific customer requirements, such as ease of use, compact size, labour-saving, weight, noise output and agility. With Blue Clean Level we direct every customer towards the ideal combination: this is why ARBC products make a real different.

BLUE CLEAN FACTOR



La combinazione ideale tra prestazioni tecniche e configurazione commerciale per poter risolvere al meglio le tue esigenze di pulizia. I prodotti che hanno il BLUE FACTOR sono i migliori, all'interno della loro categoria, per poter pulente, facilità d'utilizzo e prestazioni tecniche. Il mix perfetto per ogni tua esigenza di pulizia.

The ideal combination of technical features and commercial configuration, to deliver the best solution to your cleaning needs. Products with the BLUE FACTOR are best-in-class in cleaning power, ease of use and technical performances. The perfect mix for all your cleaning requirements.



VACUUM HOME APPLICATIONS



liquidi
fluids

grandi volumi
big volumes

interni
houses

cantine
cellars

soffitte
lofts



autorimesse
garages

balconi
balcony

cucchie
dog house,
kennels

piccoli cantieri
little
work sites

veicoli
cars



poltrone divani
armchairs
couches

spazi ristretti
limited
spaces

stufe
heaters

camini
fireplaces

griglie
grills

La gamma di aspiratori per solidi e liquidi AR BLUE CLEAN è un pratico alleato per aiutarti a mantenere la casa pulita. Dal design compatto, ma con motori potenti, sono la soluzione ideale per aspirare perfettamente qualsiasi tipo di sporco anche in piccoli spazi.

I numerosi accessori, che completano l'offerta di prodotto, permettono di pulire tutte le superfici in modo veloce, pratico e con risultati eccezionali.

The AR BLUE CLEAN range of handy solid/liquid vacuum cleaners give you practical assistance in keeping your home clean. Compact design for multi-purpose vacuum cleaners, ideal even for small spaces but with powerful motors for thorough cleaning of even the most stubborn dirt.

With the accessories that complete our product offering, you can clean all surfaces quickly, easily and with outstanding results.

31 Series																				
3170	●		●	●	●	●	●				●	●	●							
32 Series																				
3270	●		●	●	●	●	●				●	●	●							
33 Series																				
3370	●		●	●	●	●	●				●	●								
36 Series																				
3670	●		●	●	●	●	●				●	●								
37 Series																				
3770	●		●	●	●	●	●	●	●	●	●	●								
37 Series																				
3780	●	●	●	●	●	●	●	●	●	●	●									
Eco Series																				
E12B															●	●	●			
Eco Series																				
E15																●	●	●		
Mid Series																				
Mid20																	●	●	●	
Top Series																				
Top20																		●	●	●
M20																				
M20	●		●	●	●	●	●	●	●	●	●	●	●	●	●	●	●	●	●	●





SERIE 31	P 156
SERIE 32	P 157
SERIE 33	P 158
SERIE 36	P 159
SERIE 37	P 160
E12B	P 163
E15	P 164
MID 20	P 165
TOP 20	P 166
M20	P 167



31 Series 3170

ASPIRATORI SOLIDI LIQUIDI
wet & dry vacuum cleaners



funzione soffiante
blower function



cerniere aggancio/sgancio
rapido per pulizia filtri e fusto
quick connection/release hinges
for filter and tank cleaning



fusto raccolta in materiale plastico
plastic tank



4 ruote pivotanti e stabili
4 stable castor wheels

Caratteristiche Generali

- Aspiratore per liquidi e polveri
- Fusto raccolta in materiale plastico robusto e resistente
- Tubo d'aspirazione flessibile e resistente alla torsione
- Portaccessori integrato
- Posizione parcheggio durante le soste di lavoro
- Gancio per rimessaggio cavo d'alimentazione
- Galleggiante per interrompere l'aspirazione quando il fusto è pieno
- Cerniere aggancio-sgancio rapido per pulizia filtri e fusto
- Funzione soffiante
- Filtro alta efficienza lavabile
- Cavo elettrico di 5 metri

General Features

- Wet & Dry vacuum cleaner
- Tough, sturdy plastic tank
- Flexible, kink-resistant suction hose
- Integral accessories carrier
- Parking position for use during breaks in work
- Hook for stowing power supply cable
- Float switch to cut out suction when tank is full
- Quick connection/release hinges for filter and tank cleaning
- Blower function
- Washable high efficiency filter
- 5m power cord



MOD	COD					
		K ^{PA}	l/s	W _(MAX)	Hz	V
3170	51922	17	28	1200	50-60	220-240~

Accessori standard Standard accessories



dB(A)	l	kg
73,6	15	5.7



funzione soffiante
blower function



cerniere aggancio/sgancio
rapido per pulizia filtri e fusto
quick connection/release hinges
for filter and tank cleaning



fusto raccolto in materiale plastico
plastic tank



4 ruote pivotanti e stabili
4 stable castor wheels

Caratteristiche Generali

- Aspiratore per liquidi e polveri
- Fusto raccolto in materiale plastico robusto e resistente
- Tubo d'aspirazione flessibile e resistente alla torsione
- Portaccessori integrato
- Posizione parcheggio durante le soste di lavoro
- Gancio per rimessaggio cavo d'alimentazione
- Galleggiante per interrompere l'aspirazione quando il fusto è pieno
- Cerniere aggancio-sgancio rapido per pulizia filtri e fusto
- Funzione soffiante
- Filtro alta efficienza lavabile
- Cavo elettrico di 5 metri

General Features

- Wet & Dry vacuum cleaner
- Tough, sturdy plastic tank
- Flexible, kink-resistant suction hose
- Integral accessories carrier
- Parking position for use during breaks in work
- Hook for stowing power supply cable
- Float switch to cut out suction when tank is full
- Quick connection/release hinges for filter and tank cleaning
- Blower function
- Washable high efficiency filter
- 5m power cord



MOD	COD					
		K ^{PA}	l/s	W _(MAX)	Hz	V
3270	51923	17	28	1200	50-60	220-240~

Accessori standard Standard accessories



dB(A)	l	kg
73,6	20	6.1



33 Series 3370

ASPIRATORI SOLIDI LIQUIDI
wet & dry vacuum cleaners



funzione soffiante
blower function



cerniere aggancio/sgancio
rapido per pulizia filtri e fusto
quick connection/release hinges
for filter and tank cleaning



fusto raccolta in acciaio inox
stainless steel tank



4 ruote pivotanti e stabili
4 stable castor wheels

Caratteristiche Generali

- Aspiratore per liquidi e polveri
- Fusto raccolta in acciaio inossidabile
- Tubo d'aspirazione flessibile e resistente alla torsione
- Portaccessori integrato
- Posizione parcheggio durante le soste di lavoro
- Gancio per rimessaggio cavo d'alimentazione
- Galleggiante per interrompere l'aspirazione quando il fusto è pieno
- Cerniere aggancio-sgancio rapido per pulizia filtri e fusto
- Funzione soffiante
- Filtro alta efficienza lavabile
- Cavo elettrico di 5 metri

General Features

- Wet & Dry vacuum cleaner
- Stainless steel tank
- Flexible, kink-resistant suction hose
- Integral accessories carrier
- Parking position for use during breaks in work
- Hook for stowing power supply cable
- Float switch to cut out suction when tank is full
- Quick connection/release hinges for filter and tank cleaning
- Blower function
- Washable high efficiency filter
- 5m power cord

1400 W

20 lt

Ø 35

MOD	COD					
		K ^P A	l/s	W _(MAX)	Hz	V
3370	51924	18	33	1400	50-60	220-240~

Accessori standard Standard accessories



4340150 4340180 4341310 (2 m)



4340200 46263 4340170 46257 (20 l)



dB(A)	l	kg
73,6	20	6.3



Caratteristiche Generali

- Aspiratore per liquidi e polveri
- Fusto raccolta in acciaio inossidabile
- Tubo d'aspirazione flessibile e resistente alla torsione
- Portaccessori integrato
- Posizione parcheggio durante le soste di lavoro
- Gancio per rimessaggio cavo d'alimentazione
- Galleggiante per interrompere l'aspirazione quando il fusto è pieno
- Cerniere aggancio-sgancio rapido per pulizia filtri e fusto
- Funzione soffiante
- Tappo di scarico liquidi per svuotamento fusto
- Filtro alta efficienza lavabile
- Cavo elettrico di 5 metri

General Features

- Wet & Dry vacuum cleaner
- Stainless steel tank
- Flexible, kink-resistant suction hose
- Integral accessories carrier
- Parking position for use during breaks in work
- Hook for stowing power supply cable
- Float switch to cut out suction when tank is full
- Quick connection/release hinges for filter and tank cleaning
- Blower function
- Plug for draining liquids from tank
- Washable high efficiency filter
- 5m power cord



MOD	COD					
		K ^{PA}	l/s	W _(MAX)	Hz	V
3670	51927	19	37	1600	50-60	220-240~

Accessori standard Standard accessories



dB(A)	l	kg
73,6	30	6.5



37 Series 3770

ASPIRATORI SOLIDI LIQUIDI
wet & dry vacuum cleaners



cerniere aggancio/
sgancio rapido per
pulizia filtri e fusto
*quick connection/release
hinges for filter and tank
cleaning*

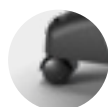

4 ruote pivotanti e stabili
4 stable castor wheels



presa elettroutensile con avvio
automatico START/STOP
power tool socket with automatic START/STOP



fusto raccolta in materiale plastico
plastic tank

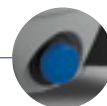

tappo per scarico liquidi
cap for drain service

Caratteristiche Generali

- Tipologia filtro: filtro alta efficienza + 1 sacchetto filtro carta
- N.4 ruote pivotanti
- Galleggiante per interrompere l'aspirazione quando il fusto è pieno
- Cerniere aggancio/sgancio rapido per pulizia filtri e fusto
- Posizione parcheggio durante le soste di lavoro
- Gancio per rimessaggio cavo d'alimentazione
- Funzione soffiante
- Funzione drenante
- Porta accessori integrato
- Resistente fusto di raccolta in plastica
- Tubo d'aspirazione resistente alla torsione
- Cavo elettrico di 5 metri

General Features

- *Main filter type: High efficiency cartridge filter + 1 paper bag*
- *N.4 castor wheels*
- *Float switch to cut out suction when tank is full*
- *Quick connection/release hinges for filter and tank cleaning*
- *Parking position for use during breaks in work*
- *Power supply cable storage hook*
- *Blower function*
- *Drain system*
- *Built-in accessory holder*
- *Sturdy plastic tank*
- *Kink-resistant suction hose*
- *5 m power cord*



MOD	COD					
		K ^{PA}	l/s	W(MAX)	Hz	V
3770	51928	19	39	1600	50-60	220-240~

◊ Potenza massima utensile 1600 W
Tool max power 1,600 W

dB(A)	l	kg NET
73,6	35	10.3

Accessori standard Standard accessories





cerniere aggancio/
sgancio rapido per
pulizia filtri e fusto
*quick connection/release
hinges for filter and tank
cleaning*



2 ruote posteriori
ø18cm per
una maggiore stabilità
*2 rear wheels ø18cm for
greater stability*



tappo per scarico liquidi
cap for drain service



4 in 1



maniglia in metallo per agevolare
i movimenti
easy-to-use metal handle



presa elettroutensile con
avvio automatico START/STOP
*power tool socket with
automatic START/STOP*



fusto raccolta in acciaio inox
stainless steel tank



Caratteristiche Generali

- Tipologia filtro: filtro alta efficienza + 1 sacchetto filtro carta
- N.2 ruote anteriori pivotanti
- Galleggiante per interrompere l'aspirazione quando il fusto è pieno
- Cerniere aggancio/sgancio rapido per pulizia filtri e fusto
- Posizione parcheggio durante le soste di lavoro
- Gancio per rimessaggio cavo d'alimentazione
- Funzione soffiante
- Funzione drenante
- Porta accessori integrato
- Resistente fusto di raccolta in plastica
- Tubo d'aspirazione resistente alla torsione
- Cavo elettrico di 5 metri

General Features

- Main filter type: High efficiency cartridge filter + 1 paper bag
- N.2 front castor wheels
- Float switch to cut out suction when tank is full
- Quick connection/release hinges for filter and tank cleaning
- Parking position for use during breaks in work
- Power supply cable storage hook
- Blower function
- Drain system
- Built-in accessory holder
- Sturdy plastic tank
- Kink-resistant suction hose
- 5m power cord



MOD	COD					
		K ^{PA}	l/s	W _(MAX)	Hz	V
3780	51929	19	41	1600	50-60	220-240~

◊ Potenza massima utensile 1600 W
Tool max power 1,600 W

dB(A)	l	kg
73,6	50	12.7

Accessori standard Standard accessories







batteria a ioni di litio
lithium ion battery



fusto raccolta in metallo
metal tank

Caratteristiche Generali

- Aspiratore per le ceneri fredde di camini, stufe e barbecue
- Cerniere aggancio/sgancio rapido per pulizia filtro e fusto
- Fusto in acciaio
- Tubo aspirazione flessibile in metallo rivestito
- Filtro alta efficienza plissettato e lavabile con protezione metallica
- Maniglia integrata

General Features

- *Fireplace, stove and barbecue cold ash vacuum cleaner*
- *Quick connection/release hinges for filter and tank cleaning*
- *Steel plate tank*
- *Metal coated flexible suction hose*
- *High-efficiency pleated and washable filter with metal guard*
- *Built-in handle*



MOD	COD								
		K ² A	l/s	min	min	Ah	V	I	kg
E12B	52004	6	16	20	240	2	18	12	3,6



Accessori standard Standard accessories





E15

ASPIRACENERE ash cleaners



Funzione soffiante
Blower function



fusto raccolta in metallo
metal tank

Caratteristiche Generali

- Aspiratore per le ceneri fredde di camini, stufe e barbecue
- Cerniere aggancio/sgancio rapido per pulizia filtro e fusto
- Fusto in acciaio
- Filtro ad alta efficienza plissettato e lavabile con protezione metallica
- Maniglia integrata
- Lunghezza cavo elettrico 1,5 m

General Features

- Fireplace, stove and barbecue cold ash vacuum cleaner
- Quick connection/release hinges for filter and tank cleaning
- Steel plate tank
- High-efficiency pleated and washable filter with metal guard
- Built-in handle
- Power cord length 1,5 m



MOD	COD							
		K ^{PA}	l/s	W(Max)	Hz	V	I	kg
E15	51993	16	23	1000	50	230~	15	3,5



Accessori standard Standard accessories





Caratteristiche Generali

- Aspiratore per le ceneri fredde di camini, stufe e barbecue
- Cerniere aggancio/sgancio rapido per pulizia filtro e fusto
- Fusto in lamiera
- Filtro alta efficienza plissettato e lavabile con protezione metallica
- Maniglia integrata
- Ganci integrati per rimessaggio cavi
- Funzione soffiante
- Lunghezza cavo elettrico 2,5 m

General Features

- Fireplace, stove and barbecue cold ash vacuum cleaner
- Quick connection/release hinges for filter and tank cleaning
- Steel plate tank
- High-efficiency pleated and washable filter with metal guard
- Built-in handle
- Built-in hooks for cable and hose reels
- Blow function
- Power cord length 2,5 m



MOD	COD							
		K ^a A	l/s	W(Max)	Hz	V	I	kg
MID 20	51583	15	28	900	50	230~	20	3,8



Accessori standard Standard accessories





Scuoti filtro
Filter shake

Rimessaggio cavo elettrico
Electric cable holder

Caratteristiche Generali

- Aspiratore per le ceneri fredde di camini, stufe e barbecue
- Cerniere aggancio/sgancio rapido per pulizia filtro e fusto
- Fusto in lamiera
- Filtro ad alta efficienza plissettato e lavabile con protezione metallica
- Maniglia ergonomica integrata
- Ganci integrati per rimessaggio cavi
- Scuotifiltro
- Lunghezza cavo elettrico 2,5 m

General Features

- Fireplace, stove and barbecue cold ash vacuum cleaner
- Quick connection/release hinges for filter and tank cleaning
- Steel plate tank
- High-efficiency pleated and washable filter with metal guard
- Built-in ergonomic handle
- Built-in hooks for cable and hose reels
- Filter shaker
- Power cord length 2,5 m



MOD	COD							
		K ^a A	l/s	W(MAx)	Hz	V	I	kg
TOP 20	51582	15	28	900	50	230~	20	3,8



Accessori standard Standard accessories





funzione soffiante
blower function

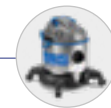

fusto raccolta in
acciaio inox
stainless steel tank



cerniere aggancio/sgancio
rapido per pulizia filtri e fusto
quick connection/release hinges
for filter and tank cleaning



4 ruote pivotanti e stabili
4 stable castor wheels



Caratteristiche Generali

- Aspiratore per ceneri, liquidi e polveri
- Fusto raccolta in acciaio inossidabile
- Tubo d'aspirazione flessibile e resistente alla torsione
- Tubo aspirazione flessibile in metallo rivestito per ceneri
- Portaccessori integrato
- Posizione parcheggio durante le soste di lavoro
- Gancio per rimessaggio cavo d'alimentazione
- Galleggiante per interrompere l'aspirazione quando il fusto è pieno
- Cerniere aggancio-sgancio rapido per pulizia filtri e fusto
- Funzione soffiante
- Filtro alta efficienza lavabile
- Cavo elettrico di 5 metri

General Features

- Ash, Wet & Dry vacuum cleaner
- Stainless steel tank
- Flexible, kink-resistant suction hose and Metal coated flexible suction hose for ash
- Integral accessories carrier
- Parking position for use during breaks in work
- Hook for stowing power supply cable
- Float switch to cut out suction when tank is full
- Quick connection/release hinges for filter and tank cleaning
- Blower function
- Washable high efficiency filter
- 5m power cord



MOD	COD					
		K ^P A	l/s	W _(MAX)	Hz	V
M20	52013	17	28	1200	50-60	220-240~

NEW

dB(A)	l	kg
73,6	20	7,2

Accessori standard Standard accessories



CLEANING **DIVISION**

VACUUM CLEANERS PRO

Gamma tecnicamente progettata per l'aspirazione di liquidi e solidi, utilizzata quotidianamente dai migliori professionisti ed artigiani. Silenziosi e pratici raccolgono con estrema facilità lo sporco, lasciando le superfici di lavoro pulite e l'ambiente circostante sano.

Range engineered for the vacuum cleaning of liquids and solids, used everyday by top professionals and craftsmen. Quiet and convenient, they pick up dirt effortlessly, leaving work surfaces clean and the surrounding environment healthy.



Applicazioni ed indicatori di prestazioni PRO

PRO performance Indicators & Applications

BLUE CLEAN PRO LEVEL

○ LIGHTPRO

Fascia di aspiratori progettati per utilizzatori esperti che hanno necessità di eseguire lavori di pulizia che richiedono una buona capacità aspirante.

Vacuum cleaner category designed for skilled users tackling cleaning jobs operations which need plenty of good suction capacity.

● HEAVYPRO

Fascia di aspiratori progettati per professionisti che hanno necessità di eseguire lavori di pulizia che richiedono massime prestazioni.

Vacuum cleaner category designed for professionals, dealing with cleaning jobs that need the very highest-performing appliances.

BLUE CLEAN FACTOR



La combinazione ideale tra prestazioni tecniche e configurazione commerciale per poter risolvere al meglio le tue esigenze di pulizia. I prodotti che hanno il BLUE FACTOR sono i migliori, all'interno della loro categoria, per poter pulente, facilità d'utilizzo e prestazioni tecniche. Il mix perfetto per ogni tua esigenza di pulizia.

The ideal combination of technical features and commercial configuration, to deliver the best solution to your cleaning needs. Products with the BLUE FACTOR are best-in-class in cleaning power, ease of use and technical performances. The perfect mix for all your cleaning requirements.

PROFESSIONAL APPLICATIONS



artigianato
crafts



car wash



automotive

Aspiratori per solidi e liquidi con fusto in acciaio inox oppure in robusto polipropilene ideali per la pulizia dello sporco più intenso e per cui è richiesta una maggiore capacità di raccolta. Estremamente manovrabili e di facile utilizzo, garantiscono prestazioni calibrate su misura alle esigenze dei diversi clienti professionisti.

Ottimi per il lavoro quotidiano delle imprese di pulizia e di piccole imprese di artigiani, gli aspiratori della gamma ARBC PRO sono stati progettati per aspirare grosse quantità di sporco grossolano e liquido. I numerosi accessori professionali di cui sono dotati ne migliorano le prestazioni e ne rendono ancora più agevole l'utilizzo.

Vacuum cleaners with stainless steel or rugged polypropylene tank, ideal for tackling the dirtiest locations and when greater collection capacity is required. Very agile and easy to use, the ARBC PRO range of vacuum cleaners guarantees performances tailored to the needs of the various kinds of professional customers.

The solid-liquid vacuum cleaners in this range are designed to collect large quantities of coarse dirt and liquids. Excellent for everyday use by cleaning contractors and small craft workshops.

All products in this range come complete with professional accessories included in the pack, to improve their performance and make them even easier and more convenient to use.

39 Series				
3930		●		
39 Series				
3950		●		
3970		●		
41 Series				
4100		●		
42 Series				
4200		●		
4200P		●		
43.44 Series				
4300P		●	●	●
4400P		●	●	●
4300E		●	●	●
4300		●	●	●
4400		●	●	●
47 Series				
4700S		●		
48 Series				
4800		●		
42L Series				
4200L		●	●	●
43L Series				
4300L		●	●	●





SERIE 39	P 174
SERIE 41	P 178
SERIE 42	P 179
SERIE 43.44	P 181
SERIE 43	P 182
SERIE 44	P 186
SERIE 47	P 187
SERIE 48	P 188
SERIE 42L	P 189
SERIE 43L	P 190
SERIE 49	P 191

OLIGHTPRO



cerniere aggancio/
sgancio rapido per
pulizia filtri e fusto
*quick connection/release
hinges for filter and tank
cleaning*

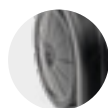

2 ruote posteriori con
battistrada in gomma
2 rubber rear wheels



fusto raccolta in acciaio inox
stainless steel tank



Caratteristiche Generali

- Modello professionale compatto dedicato all'aspirazione di polveri e liquidi
- Fusto in acciaio inox
- Ideale per la pulizia in spazi ridotti
- Cavo elettrico di 5 metri
- Galleggiante per interrompere l'aspirazione quando il fusto è pieno
- Cerniere aggancio/sgancio rapido per pulizia filtri e fusto
- Tubo d'aspirazione resistente alla torsione
- Ruote pivotanti
- Porta accessori integrato

General Features

- Professional dust and liquid vacuum cleaner
- Stainless steel body
- Ideal for cleaning in tight spaces
- 5m power cord
- Float switch to cut out suction when tank is full
- Quick coupling/release hinges for filters and tank cleaning
- Kink-resistant suction hose
- Pivoting wheels
- Integrated accessory holder



MOD	COD						
		K ^{PA}	l/s	W(M _{AX})	W	Hz	V
3930	51930	15,2	72,2	1250	1250	50-60	220-240~



dB(A)	l	kg NET
64	30	7,2

Accessori standard Standard accessories



OLIGHTPRO



Caratteristiche Generali

- Modello professionale compatto dedicato all'aspirazione di polveri e liquidi
- Fusto in acciaio inox
- 2 motori
- Ruote antitraccia
- Fusto ribaltabile
- Telaio in metallo ad alta resistenza
- Cavo elettrico di 5 metri
- Galleggiante per interrompere l'aspirazione quando il fusto è pieno
- Cerniere aggancio/sgancio rapido per pulizia filtri e fusto
- Tubo d'aspirazione resistente alla torsione
- Ruote pivotanti
- Porta accessori integrato

General Features

- Professional dust and liquid vacuum cleaner
- Stainless steel body
- 2 motors
- Non-marking wheels
- Flippable body
- High resistance metal frame
- Pivoting wheels
- 5m power cord
- Float switch to cut out suction when tank is full
- Quick coupling/release hinges for filters and tank cleaning
- Kink-resistant suction hose
- Pivoting wheels
- Integrated accessory holder



MOD	COD								
		K ^{PA}	l/s	N°	W(Max)	W	Hz	V	
3950	51931	17,9	113,9	2	2500	2100	50-60	220-240~	



dB(A)	l	kg
68	70	23

Accessori standard Standard accessories



OLIGHTPRO



Caratteristiche Generali

- Modello professionale compatto dedicato all'aspirazione di polveri e liquidi
- Fusto in acciaio inox
- 3 motori
- Ruote antitraccia
- Fusto ribaltabile
- Telaio in metallo ad alta resistenza
- Cavo elettrico di 5 metri
- Galleggiante per interrompere l'aspirazione quando il fusto è pieno
- Cerniere aggancio/sgancio rapido per pulizia filtri e fusto
- Tubo d'aspirazione resistente alla torsione
- Ruote pivotanti
- Porta accessori integrato

General Features

- Professional dust and liquid vacuum cleaner
- Stainless steel body
- 3 motors
- Non-marking wheels
- Flippable body
- High resistance metal frame
- Pivoting wheels
- 5m power cord
- Float switch to cut out suction when tank is full
- Quick coupling/release hinges for filters and tank cleaning
- Kink-resistant suction hose
- Pivoting wheels
- Integrated accessory holder



MOD	COD				
		K ^{PA}	l/s	N°	W(Max) W Hz V
3970	51932	19,6	166,7	3	3750 3150 50-60 220-240~



dB(A)	l	kg
69	70	24,5

Accessori standard Standard accessories





OLIGHTPRO



Cerniere aggancio/sgancio rapido per pulizia filtri e fusto
Quick connection/release hinges for filter and tank cleaning

fusto raccolta in acciaio inox
stainless steel tank

4 ruote pivotanti e stabili
4 stable castor wheels

Caratteristiche Generali

- Modello professionale compatto dedicato all'aspirazione di polveri e liquidi
- Fusto in acciaio inox
- Motore bi-stadio
- Ideale per la pulizia in spazi ridotti
- Galleggiante per interrompere l'aspirazione quando il fusto è pieno
- Cerniere aggancio/sgancio rapido per pulizia filtri e fusto
- Tubo d'aspirazione resistente alla torsione
- Ruote pivotanti
- Porta accessori integrato

General Features

- Professional dust and liquid vacuum cleaner
- Stainless steel body
- Two-stage motor
- Ideal for cleaning in tight spaces
- Float switch to cut out suction when tank is full
- Quick connection/release hinges for filter and tank cleaning
- Kink-resistant suction hose
- Pivoting wheels
- Built-in accessory holder



MOD	COD							
		K ^{PA}	l/s	STADI STAGES	W(Max)	W	Hz	V
4100	50180	47,2	22,1	2	1250	1100	50	230~

⁹ Potenza massima utensile 1400 W
Tool max power 1,400 W

dB(A)	l	kg
60	20	11

Accessori standard Standard accessories



50201 (ø36) 50195 (ø36) 50200 (ø36)

50197 50199 (ø36) 50196 (ø36)

51161 (ø340) 51070 50194 (ø36)/2 m

OLIGHTPRO



Cerniere aggancio/sgancio rapido per pulizia filtri e fusto
Quick connection/release hinges for filter and tank cleaning

fusto raccolta in acciaio inox
stainless steel tank

4 ruote pivotanti e stabili
4 stable castor wheels



Caratteristiche Generali

- Modello professionale compatto dedicato all'aspirazione di polveri e liquidi
- Fusto in acciaio inox
- Motore bi-stadio
- Ideale per la pulizia in spazi ridotti
- Galleggiante per interrompere l'aspirazione quando il fusto è pieno
- Cerniere aggancio/sgancio rapido per pulizia filtri e fusto
- Tubo d'aspirazione resistente alla torsione
- Ruote pivotanti
- Porta accessori integrato

General Features

- Professional dust and liquid vacuum cleaner
- Stainless steel body
- Two-stage motor
- Ideal for cleaning in tight spaces
- Float switch to cut out suction when tank is full
- Quick connection/release hinges for filter and tank cleaning
- Kink-resistant suction hose
- Pivoting wheels
- Built-in accessory holder



MOD	COD							
		K ^{PA}	l/s	STAGE STAGES	W(MAX)	W	Hz	V
4200	50181	59,7	23,5	2	1400	1200	50	230~

[°] Potenza massima utensile 1400 W
Tool max power 1,400 W

dB(A)	l	kg
60	36	13,7

Accessori standard Standard accessories





42 Series 4200P

ASPIRATORI SOLIDI LIQUIDI
wet & dry vacuum cleaners

OLIGHTPRO



Cerniere aggancio/sgancio rapido per pulizia filtri e fusto
Quick connection/release hinges for filter and tank cleaning



Fusto raccolta in materiale plastico robusto e resistente
Tough, sturdy plastic tank



4 ruote pivotanti e stabili
4 stable castor wheels



Caratteristiche Generali

- Serie professionale compatta dedicata all'aspirazione di polveri e liquidi
- Fusto in polipropilene
- Motore bi-stadio
- Ideale per la pulizia in spazi ridotti

General Features

- Professional dust and liquid vacuum cleaner series
- Polypropylene body
- Two-stage motor
- Ideal for cleaning in tight spaces

1400 W

36 lt

Ø 40

MOD	COD							
		K ^{PA}	l/s	STADI STAGES	W(MAX)	W	Hz	V
4200P	51061	59,7	23,5	2	1400	1200	50	230~



° Potenza massima utensile 1400 W
Tool max power 1,400 W



dB(A)

60



l

36



kg

12,6

Accessori standard Standard accessories



50207 (ø37)



50204 (ø40)



50208 (ø37)



50206



50203 (ø40)



50205 (ø40)



50413 (ø340)



51070



50202 (ø40)/2,5 m

HEAVYPRO



Caratteristiche Generali

- Modello professionale compatto dedicato all'aspirazione di polveri e liquidi
- Fusto in acciaio inox
- Motore bi-stadio
- Galleggiante per interrompere l'aspirazione quando il fusto è pieno
- Cerniere aggancio/sgancio rapido per pulizia filtri e fusto
- Tubo d'aspirazione resistente alla torsione
- Ruote pivotanti
- Porta accessori integrato

General Features

- Professional dust and liquid vacuum cleaner
- Stainless steel body
- Two-stage motor
- Float switch to cut out suction when tank is full
- Quick connection/release hinges for filter and tank cleaning
- Kink-resistant suction hose
- Pivoting wheels
- Built-in accessory holder

4300P	4400P
2400 W	3300 W
77 lt	77 lt
Ø 40	Ø 40

MOD	COD									
		K ^{PA}	l/s	N°	STADI STAGES	W(Max)	W	Hz	V	
4300P	51062	94,5	22,1	2	2	2400	2050	50	230~	
4400P	51064	141,7	22,1	3	2	3300	2900	50	230~	

[°]Potenza massima utensile 1400 W
Tool max power 1,400 W

dB(A)	l	kg
67	77	22
68	77	27

Accessori standard Standard accessories





43 Series 4300E

ASPIRATORI SOLIDI LIQUIDI
wet & dry vacuum cleaners

HEAVYPRO

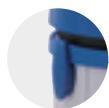

Cerniere aggancio/sgancio rapido per pulizia filtri e fusto
Quick connection/release hinges for filter and tank cleaning



Fusto raccolta in materiale plastico robusto e resistente
Tough, sturdy plastic tank



4 ruote pivotanti e stabili
4 stable castor wheels



Caratteristiche Generali

- Modello professionale compatto dedicato all'aspirazione di polveri e liquidi
- Fusto in acciaio inox
- Motori bi-stadio
- Ideale per la pulizia in spazi ridotti
- Galleggiante per interrompere l'aspirazione quando il fusto è pieno
- Cerniere aggancio/sgancio rapido per pulizia filtri e fusto
- Tubo d'aspirazione resistente alla torsione
- Ruote pivotanti
- Porta accessori integrato

General Features

- Professional dust and liquid vacuum cleaner
- Stainless steel body
- Two-stage motors
- Ideal for cleaning in tight spaces
- Float switch to cut out suction when tank is full
- Quick connection/release hinges for filter and tank cleaning
- Kink-resistant suction hose
- Pivoting wheels
- Built-in accessory holder

2400 W

77 lt

Ø 40

MOD	COD									
		K ^P A	l/s	N°	STADI STAGES	W(Max)	W	Hz	V	
4300E	51063	94,5	22,1	2	2	2400	2050	50	230~	



dB(A)	l	kg
67	77	21

Accessori standard Standard accessories







HEAVYPRO



fusto basculante
body which tilts for
emptying

fusto raccolta in acciaio inox
stainless steel tank

2 ruote posteriori con
battistrada in gomma
2 rubber rear wheels

2 ruote pivotanti e stabili
2 stable castor wheels



Caratteristiche Generali

- Modello professionale compatto dedicato all'aspirazione di polveri e liquidi
- Fusto in acciaio inox
- Motori bi-stadio
- Galleggiante per interrompere l'aspirazione quando il fusto è pieno
- Cerniere aggancio/sgancio rapido per pulizia filtri e fusto
- Tubo d'aspirazione resistente alla torsione
- Ruote pivotanti
- Porta accessori integrato

General Features

- Professional dust and liquid vacuum cleaner
- Stainless steel body
- Two-stage motors
- Float switch to cut out suction when tank is full
- Quick connection/release hinges for filter and tank cleaning
- Kink-resistant suction hose
- Pivoting wheels
- Built-in accessory holder



MOD	COD									
		K ^{PA}	l/s	N°	STADI STAGES	W(MAX)	W	Hz	V	
4300	50182	94,5	22,1	2	2	2400	2050	50	230~	



dB(A)	l	kg
67	77	24

Accessori standard Standard accessories





44 Series 4400

ASPIRATORI SOLIDI LIQUIDI
wet & dry vacuum cleaners

HEAVYPRO



fusto basculante
body which tilts for
emptying



fusto raccolta in acciaio inox
stainless steel tank



2 ruote posteriori con
battistrada in gomma
2 rubber rear wheels



2 ruote pivotanti e stabili
2 stable castor wheels



Caratteristiche Generali

- Modello professionale compatto dedicato all'aspirazione di polveri e liquidi
- Fusto in acciaio inox
- Motori bi-stadio
- Galleggiante per interrompere l'aspirazione quando il fusto è pieno
- Cerniere aggancio/sgancio rapido per pulizia filtri e fusto
- Tubo d'aspirazione resistente alla torsione
- Ruote pivotanti
- Porta accessori integrato

General Features

- Professional dust and liquid vacuum cleaner
- Stainless steel body
- Two-stage motors
- Float switch to cut out suction when tank is full
- Quick connection/release hinges for filter and tank cleaning
- Kink-resistant suction hose
- Pivoting wheels
- Built-in accessory holder

3300 W

77 lt

Ø 40

MOD	COD								
		K ^P A	l/s	N°	STADI STAGES	W(MAX)	W	Hz	V
4400	50183	141,7	22,1	3	2	3300	2900	50	230~



dB(A)	l	kg
68	77	29

Accessori standard Standard accessories



HEAVYPRO



Caratteristiche Generali

- Modello professionale compatto dedicato all'aspirazione di polveri e liquidi
- Fusto in acciaio inox
- Motori bi-stadio
- Ideale per la pulizia in spazi ridotti
- Galleggiante per interrompere l'aspirazione quando il fusto è pieno
- Cerniere aggancio/sgancio rapido per pulizia filtri e fusto
- Tubo d'aspirazione resistente alla torsione
- Ruote pivotanti
- Porta accessori integrato
- Presa elettrica per elettroutensile

General Features

- Professional dust and liquid vacuum cleaner
- Stainless steel body
- Two-stage motors
- Ideal for cleaning in tight spaces
- Float switch to cut out suction when tank is full
- Quick connection/release hinges for filter and tank cleaning
- Kink-resistant suction hose
- Pivoting wheels
- Built-in accessory holder
- Electric socket for power tool



MOD	COD							
		K ^{PA}	l/s	STADI STAGES	W(MAX)	W	Hz	V
4700S [°]	51065	59,7	23,5	2	1400	1200	50	230~

[°] Potenza massima utensile 1400 W
Tool max power 1,400 W

dB(A)	l	kg
60	36	14

Accessori standard Standard accessories





48 Series 4800

ASPIRAPOLVERI
vacuum cleaners

HEAVYPRO



Caratteristiche Generali

- Modello professionale dedicato all'aspirazione di sole polveri
- Fusto in acciaio inox
- Motore bi-stadio
- Con presa elettrica per elettroutensile e dispositivo scuotifiltro automatico
- Filtro ad alta efficienza

General Features

- Professional vacuum cleaner for dry materials only
- Stainless steel body
- Two-stage motor
- With power tool socket and automatic filter shaker device
- High efficiency filter



MOD	COD								
		K ^{PA}	l/s	STADI STAGES	W(MAX)	W	Hz	V	
4800 [°]	51203	59,7	23,5	2	1400	1200	50	230~	

[°] Potenza massima utensile 1400 W
Tool max power 1,400 W

dB(A)	l	kg
60	37	13,9

Accessori standard Standard accessories



HEAVYPRO



Caratteristiche Generali

- Modello professionale dedicato alla pulizia di tappeti, poltrone e pavimenti
- Motore bi-stadio
- Serbatoio detergente incorporato (capacità 8l)
- Fusto in plastica
- L'utilizzo è sempre associato alla contemporanea erogazione ed aspirazione di detergente (acqua o miscela di acqua e detergente idoneo da effettuare prima di immettere nel serbatoio con portata di 0,8 l/min a 2 bar di pressione)

General Features

- Professional vacuum cleaner for cleaning carpets, upholstery and floors
- Two-stage motor
- Built-in detergent tank (capacity 8 l)
- Plastic body
- When in operation, it simultaneously delivers and sucks in detergent (water or a mixture of water and a suitable detergent, to be prepared before transfer to the tank) with a flow rate of 0.8 l/min at a pressure of 2 bar.



MOD	COD								
		K ^P A	l/s	STADI STAGES	W(MAx)	W	Hz	V	
4200L	51289	59,7	23,5	2	1400	1200	50	230~	

l/min	bar	W	l
0,8	2	48	8

dB(A)	l	kg
60	36	14

Accessori standard Standard accessories





43L Series 4300L

ASPIRATORI SOLIDI LIQUIDI
wet & dry vacuum cleaners

HEAVYPRO



fusto basculante
body which tilts for emptying



serbatoio detergente incorporato (20l)
built-in detergent tank (20 l)

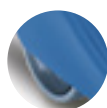

2 ruote posteriori con battistrada in gomma
2 rubber rear wheels



presa detergente
detergent socket



fusto raccolta in acciaio inox
stainless steel tank

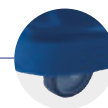

2 ruote pivotanti e stabili
2 stable castor wheels



Caratteristiche Generali

- Modello professionale dedicato alla pulizia di tappeti, poltrone e pavimenti
- Motori bi-stadio
- Serbatoio detergente incorporato (capacità 20l)
- Fusto basculante in acciaio inox
- L'utilizzo è sempre associato alla contemporanea erogazione ed aspirazione di detergente (acqua o miscela di acqua e detergente idoneo da effettuare prima di immettere nel serbatoio con portata di 0,8 l/min a 2

General Features

- Professional vacuum cleaner for cleaning carpets, upholstery and floors
- Two-stage motors
- Built-in detergent tank (capacity 20 l)
- Tilting stainless steel body
- When in operation, it simultaneously delivers and sucks in detergent (water or a mixture of water and a suitable detergent, to be prepared before transfer to the tank) with a flow rate of 0.8 l/min at a pressure of 2 bar.



MOD	COD								
		K ^P A	l/s	N°	STADI STAGES	W(MAX)	W	Hz	V
4300L	51205	94,5	23,5	2	2	2400	2300	50	230~

CHEM	CHEM	kw	CHEM
l/min	bar	W	l
0,8	2	48	20

dB(A)	l	kg
67	76	27,5

Accessori standard Standard accessories



51215 (ø40)/2,5 m



51216



51070



HEAVYPRO



Caratteristiche Generali

- Modello professionale dedicato all'aspirazione di trucioli da lavorazioni metalliche industriali
- Filtro di aspirazione ad elevata superficie filtrante e protezione a barriera
- Fusto in acciaio inox
- Motori bi-stadio
- Carrello, maniglia e fusto basculante per svuotamento
- Filtro ad alta efficienza

General Features

- Model specifically designed for collection of shavings from industrial metalworking processes
- Suction filter with large filtering surface area and barrier protection
- Stainless steel body
- Two-stage motors
- Trolley, handle and tilting body for emptying
- High efficiency filter

3600 W	77 lt
Ø 50	

MOD	COD					W(MAX)	W	Hz	V
		K ^{PA}	l/s	N°	STADI STAGES				
4900	51067	179,2	23,5	3	2	3600	3150	50	230~



dB(A)	l	kg
68	77	29,8

Accessori standard Standard accessories



ACCESSORI

Accessories





ACCESSORI SPECIALI

SPECIAL ACCESSORIES

ACCESSORIO 3 IN 1

SIDEKICK PRO

Cod. 46267

L'accessorio 3 in 1 ARBC è un aiuto nei lavori di bricolage domestici. Ha una tripla funzione: sorregge piccole mensole o listelli; permette di regolarne l'altezza grazie al supporto rotante a 360°; raccoglie la polvere di fori da trapano su pareti e soffitti.

AR Blue Clean Sidekick Pro accessory is an helpful tool in domestic and DIY works. It has a triple function: supports small shelves or strips; allows you to adjust the height thanks to the 360° rotating support; collects dust from drill holes on walls and ceilings.





RACCOGLIPOLVERE DA FORATURA

DRILLDUST COLLECTOR

Cod. 46266

L'accessorio raccogli-polvere da foratura per aspiratori solidi e liquidi ARBC permette di raccogliere la polvere generata dall'utilizzo di trapani e avvitatori.

DrillDust Collector accessory for AR Blue Clean solid and liquid vacuum cleaners allows to collect the dust from drills and screwdrivers.

VENTOSA STURATUBI

DRAIN UNBLOCKER







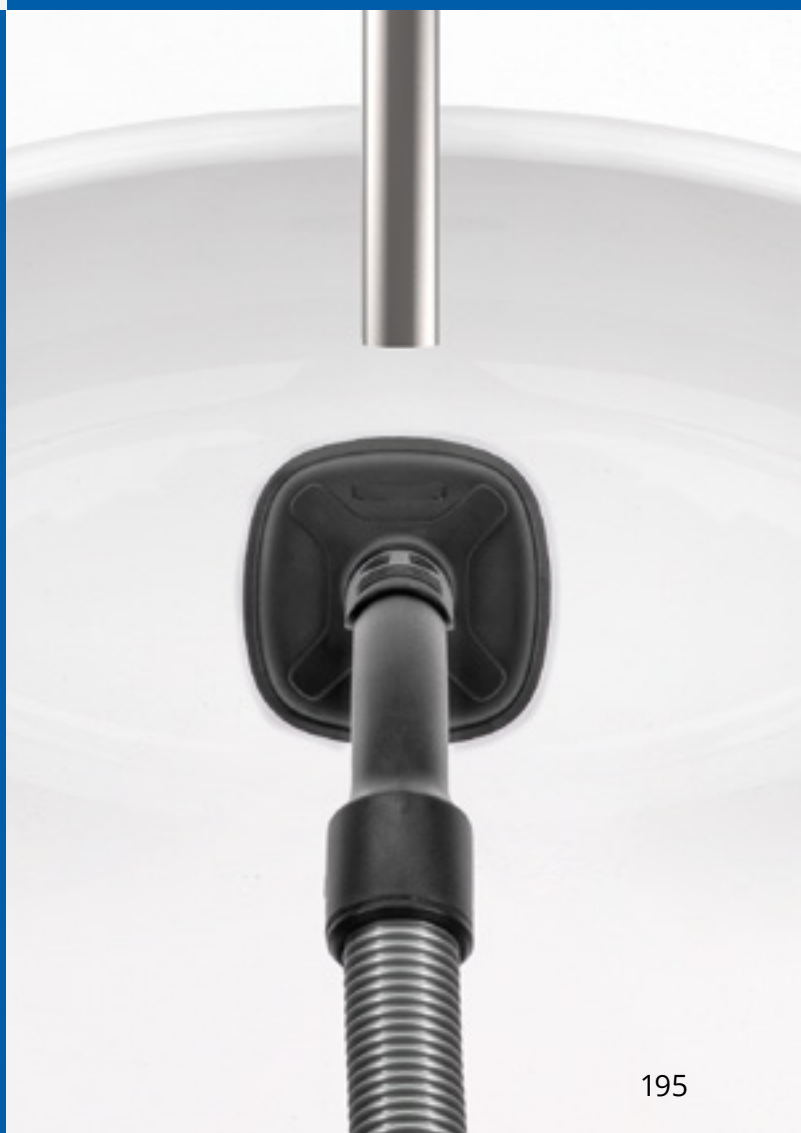







Cod. 46265

L'accessorio ventosa sturatubi per aspiratori solidi e liquidi ARBC consente di liberare e ripulire gli scarichi intasati. Grazie alla potenza dell'aspirazione garantisce una pulizia profonda senza residui. L'innovativo design permette l'aderenza a tutte le tipologie di scarichi.



























The Drain Unblocker accessory for AR Blue Clean solid and liquid vacuum cleaners allows you to free and clean up clogged drains. Thanks to the suction power guarantees a deep cleaning without residues. The innovative design allows adherence to all kind of drains.



			31 Series	32 Series	33 Series	36 Series	37 Series	ASH cleaners					39 Series	41 Series	42 Series	43 Series	44 Series	47 Series	48 Series	42 Series	43 Series	49 Series						
			3170	3270	3370	3670	3770	3780	E12B	E15	MID 20	TOP20	M20	3930	3950	3970	4100	4200	4200P	4300P	4400P	4300E	4300	4400	4700S	4800	4200L	4300L
Spazzola per pavimenti secco/umido <i>Floor wet&dry brush</i>		4340150 (ø35)	S	S	S	S	S																					
Spazzola per pavimenti per umido <i>Brush for wet floor</i>		4341430 (ø35)	O	O	O	O	O																					
		4341330 (ø40)						S																				
Spazzola combinata in plastica per pavimenti <i>Combined plastic floor brush</i>		4341340 (ø35) solo secco <i>dry only</i>	O	O	O	O	O																					
Spazzola combinata con inserto metallico per pavimenti <i>Combined metal floor brush</i>		4340750 (ø40) solo secco <i>dry only</i>	O	O	O	O	O																					
		4341370 (ø40) solo secco <i>dry only</i>						O																				
Spazzola per pavimenti combinata solo secco <i>Combined floor brush dry only</i>		46254 (ø35)	O	O	O	O	O																					
Spazzola per pulizia tappeti e poltrone <i>Carpet and upholstery brush</i>		4340180 (ø35)	S	S	S	S	S																					
Spazzola rotonda <i>Round brush</i>		46255 (ø35)	O	O	O	O	O																					
		4341360 (ø40)						S																				
Bocchetta per superfici secco/umido <i>Wet&dry nozzle</i>		4340740 (ø40)						O																				
Bocchetta per fessure <i>Crevice nozzle</i>		4340170 (ø35)	S	S	S	S	O																					
Bocchetta grande per fessure <i>Wide crevice nozzle</i>		4340730 (ø35)					S																					
Bocchetta per fessure <i>Crevice nozzle</i>		4341350 (ø40)						S																				
Ventosa sturatubi <i>Suction cup drain unblocker</i>		46265	O	O	O	O	O	O																				
Raccogli polvere da foratura <i>Drilldust collector</i>		46266	O	O	O	O	O	O																				
Accessorio 3in1 <i>Sidekick Pro 3in1</i>		46267	O	O	O	O	O	O																				
Adattatore per elettroattrezzi <i>Adapter for power tools</i>		46264						S	S																			
Tubo di aspirazione con gomito 2 m <i>Suction hose with elbow 2m</i>		4341310 (ø35)	S	S	S	S	S																					
		4341320 (ø40)						S																				

		31 Series	32 Series	33 Series	36 Series	37 Series	ASH cleaners					39 Series	41 Series	42 Series	43 Series	44 Series	47 Series	48 Series	42 Series	43 Series	49 Series											
		3170	3270	3370	3670	3770	E12B	E15	MID 20	TOP20	M20	3930	3950	3970	4100	4200	4200P	4300P	4400P	4300E	4300	4400	4700S	4800	4200L	4300L	4900					
Tubo di aspirazione con gomito <i>Suction hose with elbow</i>		4341780 (ø35/5 m)	O	O	O	O																										
		4341800 (ø35/10 m)																														
		4341790 (ø40/5 m)	O	O	O	O	O																									
		4341810 (ø40/10 m)																														
Tubo rigido di aspirazione in plastica <i>Plastic suction tube</i>		4340200 (ø35/3x330 mm)	S	S	S						S																					
		4340210 (ø35/2x470 mm)				S																										
Tubi rigidi di aspirazione in metallo <i>Metal suction tubes</i>		4340230 (ø35/2x470 mm)	O	O	O	O	S				O																					
		4341380 (ø40/2x480 mm) con gancio rimessaggio w/storage hook						S																								
Tubo telescopico in acciaio inossidabile <i>Stainless steel telescopic tube</i>		4340240 (ø35/480-780mm)	O	O	O	O	O				O																					
Sacchetto filtro carta <i>Paper filter bag</i>		46256 (15 l)	O																													
		46257 (20 l)		O	S						O																					
		46258 (30 l)				S																										
		46270 (35 l)					S																									
		46271 (50 l)						S																								
Filtro stoffa lavabile <i>Washable fabric filter bag</i>		46259 (15 l)	O																													
		46260 (20 l)		O	O						O																					
		46261 (30 l)				O																										
		46313 (35 l)					O																									
		46314 (50 l)						O																								
Filtro in spugna <i>Sponge filter</i>		46315	O																													
		46262		O	O	O	O	O																								
Filtro cartuccia ad alta efficienza <i>High efficiency cartridge</i>		4341690									S																					
		46269 (h= 91 mm)	S																													
Tubo aspirazione flessibile in metallo <i>Flexible metal hose</i>		5060130 (ø35 mm/1 m)					S																									
		5060060 (ø40 mm/1,2 m)						S																								
		4520050 (ø40 mm/1 m)							S	S																						
Tubo in alluminio <i>Aluminum suction tube</i>		4341700 (ø40 mm/1,2 m)									S																					
		5060070 (ø34 mm/23 cm)					S	S																								
		4520050 (ø34 mm/23 cm)							S	S																						
	4341710 (ø34 mm/23 cm)											S																				

		31 Series	32 Series	33 Series	36 Series	37 Series	ASH cleaners					39 Series	41 Series	42 Series	43 Series	44 Series	43 Series	44 Series	47 Series	48 Series	42 Series	43 Series	49 Series						
		3170	3270	3370	3670	3770	3780	E12B	E15	MID 20	TOP20	M20	3930	3950	3970	4100	4200	4200P	4300P	4400P	4300E	4300	4400	4700S	4800	4200L	4300L	4900	
Prefiltro in tessuto ritardante <i>Fire retardant prefilter</i>		4520120						O	O	S	S	O																	
Filtro cartuccia <i>Cartridge filter</i>			4341680 (h= 115 mm)									S																	
Filtro alta efficienza plissettato con protezione metallica <i>High efficiency pleated filter with metal garde</i>			5060120 (h= 115 mm)				S																						
			5060050 (h= 123 mm)					S																					
			4520030 (h= 100 mm)							S	S																		
Corpo spazzola <i>Nozzle body</i>			4940030 (ø36)									S																	
Inserto spazzola pavimenti per umido <i>Wet floor brush insert</i>			4940040 (ø36)									S																	
Inserto spazzola pavimenti per secco <i>Dry floor brush insert</i>			4940050 (ø36)									S																	
Corpo spazzola <i>Nozzle body</i>			4940060 (ø40)										S	S															
Inserto spazzola pavimenti per umido <i>Wet floor brush insert</i>			4940070 (ø40)										S	S															
Inserto spazzola pavimenti per secco <i>Dry floor brush insert</i>			4940080 (ø40)										S	S															
Bocchetta <i>Small nozzle</i>			4940110 (ø36)									S																	
Pennello <i>Round brush</i>			4940120 (ø36)									S																	
			4940130 (ø40)										S	S															
Lancia piatta <i>Crevice nozzle</i>			4940090 (ø36)									S																	
			4940100 (ø40)										S	S															
Tubo aspirazione <i>Suction hose</i>			4940010 (ø36/2 m) con gomito <i>with elbow</i>									S																	
			4940020 (ø40/2,5 m)										S	S															

		31 Series	32 Series	33 Series	36 Series	37 Series	ASH cleaners					39 Series	41 Series	42 Series	43 Series	43 Series	44 Series	47 Series	48 Series	42 Series	43 Series	49 Series							
		3170	3270	3370	3670	3770	3780	E12B	E15	MID 20	TOP20	M20	3930	3950	3970	4100	4200	4200P	4300P	4400P	4300E	4300	4400	4700S	4800	4200L	4300L	4900	
Tubo di aspirazione in metallo <i>Metal suction tube</i>	 4940140 (ø36/1x500mm)												S																
	 4940150 (ø40/2x500mm)													S	S														
Filtro tela <i>Textile filter</i>	 4940160												S																
	 4940170												S	S															
Filtro antischiuma <i>Anti foam filter</i>	 4940180												S																
	 4940190												S	S															
Filtro in nylon <i>Nylon surfilter</i>	 4940200												O																
	 4940210												O	O															
Sacca in microfibra <i>Microfiber bag</i>	 4940220												O																
	 4940230												O	O															
Filtro cartuccia <i>Cartridge filter</i>	 4940240												O																
Spazzola pavimenti combinata in acciaio <i>Steel cominated brush</i>	 50200 (ø36)															S													
Spazzola completa liquidi <i>Floor brush (only wet)</i>	 50201 (ø36)															S													
	 50208 (ø37)															S	S												
	 50210 (ø37/L 400 mm)																S	S	S	S	S	S							
Spazzola pavimenti <i>Floor brush</i>	 50207 (ø36)															S	S												
	 50209 (ø37)																S	S	S	S	S	S							
Bocchettina <i>Small tool</i>	 50195 (ø36)															S													
Spazzola rotonda <i>Round brush</i>	 50199 (ø36)															S													
	 50204 (ø40)															S	S	S	S	S	S	S							
Tubo flessibile completo <i>Complete hose</i>	 50194 (ø36/2 m)															S													
	 50202 (ø40/2,5 m)															S	S	S	S	S	S								
Tubo in metratura <i>Hose supplied by the metre</i>	 51112 (ø36/15 m)															O													
	 51019 (ø36/30 m)															O													
	 51115 (ø40/15 m)																O	O	O	O	O	O	O	O	O	O	O	O	O
	 51391 (ø40/30 m)																O	O	O	O	O	O	O	O	O	O	O	O	O
Tubo flessibile + tubo idrolitico <i>Flexible hose + hydrolytic hose</i>	 51215 (ø40/2,5 m)																										S	S	

			31 Series	32 Series	33 Series	36 Series	37 Series	ASH cleaners					39 Series	41 Series	42 Series	43 Series	44 Series	47 Series	48 Series	42 Series	43 Series	49 Series							
			3170	3270	3370	3670	3770	3780	E12B	E15	MID 20	TOP20	M20	3930	3950	3970	4100	4200	4200P	4300P	4400P	4300E	4300	4400	4700S	4800	4200L	4300L	4900
Tubo flessibile + manicotti elettroattensibile <i>Flexible hose with tool fitting collars</i>		50212 (ø28/3,3 m)																							S	S			
Tubo PU antistatico <i>Antistatic PU hose</i>		51074 (ø50 / 2,5 m)																											S
Tronco conico antistatico <i>Tapered antistatic attachment</i>		51077 (ø50)																											S
Ventosa ondulata antistatica <i>Corrugated antistatic sucker</i>		51076 (ø50)																											S
Corpo spazzola polveri <i>Carpet brush body</i>		51216 (ø36)																								S	S		
Tubo prolunga plastica <i>Plastic suction tube</i>		51160 (ø36)															S	O											
		51207 (ø40)																	O	O	O	O	O	O	O	O	O	O	O
Tubo acciaio dritto <i>Chrome straight extension</i>		50197 (ø36)															S												
		50206 (ø36)																	S	S	S	S	S	S					
Tubo acciaio curvo <i>Chrome curved extension wand</i>		50205 (ø40)																	S	S	S	S	S	S					
Tubo acciaio curvo maschio <i>Chrome curved extension wand male</i>		51131																											O
Lancia conica antistatica <i>Tapered antistatic lance</i>		51075 (ø50)																											S
Lancia zincata <i>Galvanised lance</i>		51078 (ø50)																											S
Kit set accessori <i>Complete accessories kit</i>		51108																							O	O			O
Manicotto zincato giunto accessori <i>Galvanised accessories fitting collar</i>		51079 (ø50)																											S
Kit terminali per tubo in metratura <i>End piece kit for hose supplied by metre</i>		51177 (ø36)															O												
		51300 (ø28)																								O	O		
		51176 (ø40)																	O	O	O	O	O	O	O	O	O		
Manicotto per prolunga tubo flessibile <i>Connector for hose supplied by meter</i>		51206 (ø36)															O												
		51319 (ø40)																O											
		51166 (ø40)																											O

WATER PUMPS

Le pompe Annovi Reverberi sono la soluzione perfetta per liberare dall'acqua ambienti come piscine, vasche, laghetti, oppure per l'irrigazione di piante e vegetazione. Sono inoltre in grado di rimuovere l'acqua in eccesso causata da allagamenti di tipo domestico o naturale. Grazie alla funzione dell'autoclave possono integrarsi con l'approvvigionamento idrico domestico per riutilizzare l'acqua piovana o proveniente da fonti alternative per scarichi o lavatrici, evitando così l'eventuale spreco di acqua potabile.

The Annovi Reverberi pumps are the perfect solution to free water from environments such as swimming pools, ponds, or for watering plants and vegetation. They are also able to remove excess water caused by domestic or natural flooding.

Thanks to the autoclave function, they can be integrated with domestic water supply to reuse rainwater or water coming from alternative sources for drains or washing machines, thus avoiding any waste of drinking water.







ARGP 600P	P 210
ARGP 800X	P 211
ARGP 1100X	P 212
ARGP 600PB	P 216
ARGP 800XB	P 217
ARGP 1100XB	P 219
ARUP 250PC	P 222
ARUP 750XC	P 223
ARUP 750PT	P 224
ARUP 1100XD	P 227



Applicazioni

Applications



irrigazione manuale
manual irrigation



irrigazione automatica
automatic irrigation



acque per i servizi
water supply



allagamenti domestici
house flooded



pozzetti
wells



piscine
swimming pools



cantieri
construction site



stagni/laghetti
ponds



allagamenti
floodings

Caratteristiche

Features



pressione massima
max pressure



portata massima
max flow



dimensioni di montaggio
fitting dimensions



ON/OFF automatico
automatic ON/OFF



sistema di scarico
drain system

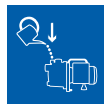

facile riempimento
easy fill



impugnatura ergonomica
handle

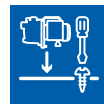

montaggio da tavolo
table mounting



serbatoio
tank



ON/OFF automatico
automatic ON/OFF

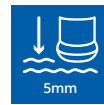

acqua residua
residual water



dimensione massima particolato
max grain size



altezza variabile
variable height



corpo in acciaio inossidabile
stainless steel body



testata pompa in acciaio inossidabile
stainless steel pump head



adatto ad acque pulite
suitable for clean water



adatto ad acque sporche
suitable for dirty water



Autoadescanti Self-priming

600P



800X



1100X



Con autoclave With booster unit

600PB



800XB



1100XB



Immersione Submersible

250PC



750XC



750PT



1100XD



POMPE AUTOADESCANTI *SELF-PRIMING* *PUMPS*

Le pompe autoadescanti della gamma Annovi Reverberi forniscono la condizione ideale per una crescita rigogliosa delle piante e garantisce una conveniente fornitura di acqua di servizio per la casa e il giardino.

Consentono il recupero dell'acqua attingendo da fonti alternative come pozzi o bacini, per sistemi di irrigazione fissi o mobili, oppure per riempire piscinette o fontane.

Grazie al sistema di risparmio energetico ON/OFF, le pompe offrono una soluzione sostenibile e rispettosa dell'ambiente.

Annovi Reverberi's self-priming jet pumps range provides the ideal condition for the lush growth of the garden plants and grants a convenient service water supply for home and garden.

It allows water recycling especially useful for fixed or mobile irrigation systems or to fill small pools or fountains, by drawing from alternative sources such as wells or basins.

Thanks to the energy saving ON / OFF system, the pumps offer a sustainable and environment friendly solution.





ARGP Series 600P

POMPE AUTOADESCANTI
self-priming pumps

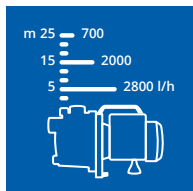

sistema di
riempimento
filling system

impugnatura ergonomica
hand grip handle

sistema di
svuotamento rapido
quick emptying system



Caratteristiche Generali

- La portata max. da 3100 l/h offre alte prestazioni
- Basso consumo energetico
- Autoadescante
- Protezione motore dalle alte temperature

General Features

- 3100 l/h max. flow rate offers high performance
- Low power consumption
- Self priming
- Motor protection at high temperatures



MAX 35m
3,5bar



MAX 3100l/h



Ø1"

MOD	COD					
		V	Hz	W	m	l/h
600P	51986	230~	50	600	35	3100

T(Max)	IP X	kg NET
35°C	4	6,3

Accessori opzionali Optional accessories



46489



46491
(1L)

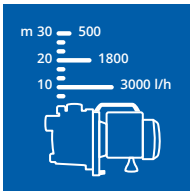

impugnatura ergonomica
hand grip handle

testata in acciaio
stainless steel head

Caratteristiche Generali

- La portata max. da 3500 l/h offre alte prestazioni
- Autoadescante
- Protezione motore dalle alte temperature

General Features

- 3500 l/h max. flow rate offers high performance
- Self-priming
- Motor protection at high temperatures



MOD	COD					
		V	Hz	W	m	l/h
800X	51988	230~	50	800	38	3500

T(Max)	IP X	kg NET
35°C	4	6,5

Accessori opzionali Optional accessories



46489



46491
(1L)



ARGP Series 1100X

POMPE AUTOADESCANTI
self-priming pumps

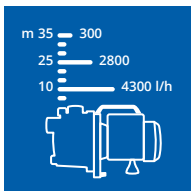

Caratteristiche Generali

- La portata max. da 4600 l/h offre alte prestazioni
- Motore performante
- Protezione motore dalle alte temperature

General Features

- 4600 l/h max. flow rate offers high performance
- Powerful motor
- Motor protection at high temperatures



MOD	COD					
		V	Hz	W	m	l/h
1100X	51990	230~	50	1100	45	4600

T(Max)	IP X	kg NET
35°C	4	9,1

Accessori opzionali Optional accessories



46489



46491
(1L)



POMPE AUTOADESCANTI CON AUTOCLAVE *SELF-PRIMING PUMPS WITH BOOSTER UNIT*

Le pompe autoadescenti con autoclave della serie AR Blue Clean forniscono acqua da utilizzare con elettrodomestici, sanitari o per l'irrigazione del giardino, mantenendo una pressione stabile e costante.

Le pompe si integrano con l'approvvigionamento idrico domestico, per l'utilizzo dell'acqua piovana, di serbatoi o di pozzi, evitando lo spreco di acqua potabile.

Grazie al sistema di risparmio energetico ON/OFF, queste pompe offrono una soluzione sostenibile e rispettosa dell'ambiente.

The self-priming pumps with pressure tank, provided by Annovi Reverberi, excel at supplying water for domestic clean water fixtures or for garden irrigation, maintaining a stable and constant pressure.

The pumps can be integrated with domestic water supply systems, since their use of rainwater, drawn from tanks or wells, prevents the waste of drinking water.

Thanks to the energy saving ON/OFF system, the pumps offer a sustainable and environment friendly solution.





ARGP Series 600PB

POMPE AUTOADESCANTI
CON AUTOCLAVE
self-priming pumps with booster unit

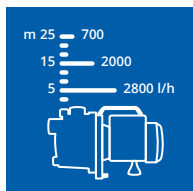
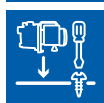

riempimento
pompa facilitato
pump easy fill

impugnatura
ergonomica
hand grip handle

ON/OFF automatico
automatic ON/OFF



Caratteristiche Generali

- La portata max. da 3100 l/h offre alte prestazioni
- Serbatoio 19L in acciaio al carbonio
- Interruttore automatico ON/OFF
- Protezione motore dalle alte temperature

General Features

- 3100 l/h max. flow rate offers high performance
- 19L carbon steel pressure tank
- Automatic ON/OFF switch
- Motor protection at high temperatures



MOD	COD					
		V	Hz	W	m	l/h
600PB	51987	230~	50	600	35	3100

T(Max)	IP X	kg NET
35°C	4	10,8

Accessori opzionali Optional accessories



46489



46492
(2L)

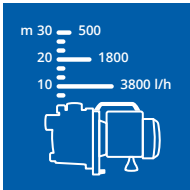
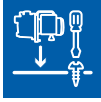

Caratteristiche Generali

- La portata max. da 3500 l/h offre alte prestazioni
- Serbatoio 19L in acciaio al carbonio
- Interruttore automatico ON/OFF
- Protezione motore dalle alte temperature

General Features

- 3500 l/h max. flow rate offers high performance
- 19L carbon steel pressure tank
- Automatic ON/OFF switch
- Motor protection at high temperatures



MOD	COD					
		V	Hz	W	m	l/h
800XB	51989	230~	50	800	38	3500

T(Max)	IP X	kg NET
35°C	4	10,9

Accessori opzionali Optional accessories



46489



46492
(2L)



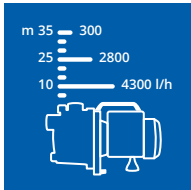
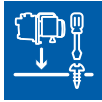

Caratteristiche Generali

- La portata max. da 4600 l/h offre alte prestazioni
- Motore performante
- Serbatoio 24L in acciaio al carbonio
- Interruttore automatico ON/OFF
- Protezione motore dalle alte temperature

General Features

- 4600 l/h max. flow rate offers high performance
- Powerful motor
- 24L carbon steel pressure tank
- Automatic ON/OFF switch
- Motor protection at high temperatures

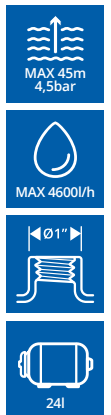

MOD	COD	V	Hz	W	m	l/h
1100XB	51991	230~	50	1100	45	4600

T(Max)	IP X	kg NET
35°C	4	14,1

Accessori opzionali Optional accessories



46489



46492
(2L)

POMPE AD IMMERSIONE *SUBMERSIBLE PUMPS*

Elimina ogni residuo di acqua!
Le pompe ad immersione della gamma AR Blue Clean spostano grandi quantità di acqua in poco tempo, fino a 16000 litri all'ora. Le pompe possono essere utilizzate per trasportare acqua pulita o sporca. Il design innovativo consente all'utente di rimuovere l'acqua lasciando solo 5mm di acqua residua sulla superficie piana. Il caratteristico interruttore a galleggiante consente di avviare automaticamente le pompe quando necessario.

*Get rid of any water residue!
Annovi Reverberi submersible pumps move large volumes of water in a short time, up to 16000 liters per hour. They can be used to pump out clean or dirty water. The innovative design allows the user to remove the water leaving only 5mm of residual water on the flat surface. The characteristic float switch allows the pumps to be started automatically whenever necessary.*





ARUP Series 250PC

POMPE AD IMMERSIONE
submersible pumps



G 1" 1/2 - 38 mm
G 1" - 25 mm
Ø 1" - 25 mm
Ø 1" 1/4 - 32 mm



galleggiante con sistema di accensione/spegnimento float with ON/OFF system

acque pulite
clean water

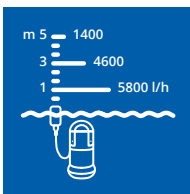

Caratteristiche Generali

- Motore a basso consumo
- Interruttore a galleggiante integrato
- 5 mm min. di livello di aspirazione
- Protezione motore dalle alte temperature

General Features

- Low consumption motor
- Integrated float switch
- 5mm minimum suction level
- Motor protection at high temperatures



MOD	COD					
		V	Hz	W	m	l/h
250PC	51982	230~	50	250	6	6000

T(Max)	IP X	kg NET
35°C	8	3,7

Accessori opzionali Optional accessories



46490

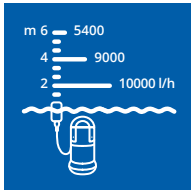

G 1" - 25 mm
Ø 1" - 25 mm
Ø 1" 1/4 - 32 mm



acque pulite
clean water



galleggiante con sistema
di accensione/spengimento
float with ON/OFF system

Caratteristiche Generali

- Design compatto
- Corpo in acciaio inox resistente alla corrosione
- Protezione motore dalle alte temperature

General Features

- Compact design
- Corrosion-resistant stainless steel body
- Motor protection at high temperatures



MOD	COD	V	Hz	W	m	l/h
750XC	51984	230~	50	750	8,5	11000

T(Max)	IP X	kg NET
35°C	8	5

Accessori opzionali Optional accessories



46490



ARUP Series 750PT

POMPE AD IMMERSIONE
submersible pumps

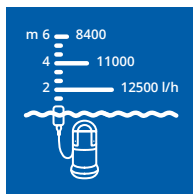

G 1" 1/2 - 38 mm
G 1" - 25 mm
Ø 1" - 25 mm
Ø 1" 1/4 - 32 mm

altezza variabile
per il passaggio
di acqua pulita/sporca
*variable height for passage
of clean/dirty water*



galleggiante con sistema
di accensione/spengimento
float with ON/OFF system

Caratteristiche Generali

- Interruttore a galleggiante integrato
- Piedi pieghevoli per variare l'aspirazione da acque chiare a scure
- Protezione motore dalle alte temperature

General Features

- *Integrated float switch*
- *Folding legs to swith from clean to dirty water suction*
- *Motor protection at high temperatures*



MOD	COD					
		V	Hz	W	m	l/h
750PT	51983	230~	50	750	8	13000

T(Max)	IP X	kg NET
35°C	8	5,24

Accessori opzionali *Optional accessories*



46490

Sistema multifunzione.

Multifunction system.



MODALITÀ ACQUA SPORCA

Aperto i piedi della pompa si ha la possibilità di drenare acque molto sporche con residui di diametro fino a 30 mm.

DIRTY WATER MODE

Unfolding the pump feet you can drain very dirty water with residues up to 30mm in diameter.

MODALITÀ ACQUA PULITA
Con i piedi chiusi la pompa consente il drenaggio di acqua pulita lasciando un residuo di soli 5 mm.

CLEAN WATER MODE

Folding the pump feet allows you the drainage of clean water leaving a residue of only 5 mm.



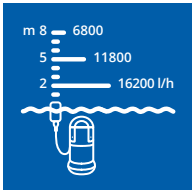

G 1" 1/2 - 38 mm
G 1" - 25 mm
Ø 1" - 25 mm
Ø 1" 1/4 - 32 mm

acque sporche
dirty water

galleggiante con sistema
di accensione/spegnimento
float with ON/OFF system



Caratteristiche Generali

- Motore performante
- Corpo in acciaio inox resistente alla corrosione
- Protezione motore dalle alte temperature

General Features

- Powerful motor
- Corrosion-resistant stainless steel body
- Motor protection at high temperatures



MOD	COD					
		V	Hz	W	m	l/h
1100XD	51985	230~	50	1100	10,5	16500

T(Max)	IP X	kg NET
35°C	8	6,6

Accessori opzionali Optional accessories



46490

			Autoadescanti <i>Self-priming</i>			Con autoclave <i>With booster unit</i>			Immissione <i>Submersible</i>			
			600P	800X	1100X	600PB	800XB	1100XB	250PC	750XC	750PT	1100XD
Tubo di aspirazione <i>Suction hose</i>		46489	<input type="checkbox"/>	<input type="checkbox"/>	<input type="checkbox"/>	<input type="checkbox"/>	<input type="checkbox"/>	<input type="checkbox"/>				
Tubo di mandata <i>Delivery hose</i>		46490							<input type="checkbox"/>	<input type="checkbox"/>	<input type="checkbox"/>	<input type="checkbox"/>
Prefiltro <i>Water filter</i>		46491 (1L)	<input type="checkbox"/>	<input type="checkbox"/>	<input type="checkbox"/>							
Prefiltro <i>Water filter</i>		46492 (2L)				<input type="checkbox"/>	<input type="checkbox"/>	<input type="checkbox"/>				





MERCHAN- DISING



AR Blue Display

MERCHANDISING
merchandising



A

ESPOSITORI
EXHIBITORS



B

ESPOSITORI
EXHIBITORS



C

BANDIERE
FLAGS



D

TOTEM



E

CUBI
CUBES



F

CORNER



G

CORNER DISPLAY



H

TESTER

Adatti per allestire punti vendita, showroom ed insegne, i supporti in cartotecnica realizzati a marchio ARBC, hanno una buona resistenza all'usura e possono essere utilizzati sia per uso interno che esterno.

Lo spazio di un negozio non può essere neutrale, per questo i supporti alla vendita a marchio ARBC sono stati progettati in base alle necessità del punto vendita stesso, permettendo così di trovare il giusto punto di incontro fra l'offerta e la percezione che il cliente ne può avere.

Un punto vendita accogliente ed invitante infatti è fondamentale per mettere a proprio agio i clienti e incentivarli all'acquisto, è per questo che Annovi Reverberi ha deciso di mettere in risalto i prodotti nei diversi punti vendita unendo estetica e funzionalità.

Suitable for point of sale and showroom outfitting and for signs, ARBC brand cardboard sales tools are hard-wearing and can be used both indoors and outdoors.

A store space cannot be anonymous, and so ARBC sales tools are designed specifically for the point of sale's needs, establishing the right connection between the offering and the customer's perception of it.

An attractive, inviting point of sale is fundamental for putting customers at their ease and encouraging them to purchase, and so Annovi Reverberi has chosen this stylish yet very practical means of highlighting its products in the various points of sale.

Dati Tecnici / Technical Data

MOD	REF	COD	DIMENSIONS (LxWxH)	kg	N° PEZZI
AR Blue Display	A	900000026	530x541X2231	26	1
Detergent Display	B	900000027	440x305x1580	4,5	64
AR Flag	C	900000028	780x600x2380	2,0	1
AR Totem	D	94786	430X200X1530	0,7	1
AR Cubes	E	94781	420X420X420	0,9	1
AR Corner	F	900000162	400X300X1800	7,5	1
AR Corner Display	G	900000163	400X300X1800	8,5	1
AR Tester	H	900000164	400X330X750	9,0	1

AR BLUE CLEAN

2X 2 POWER UNITS,
DOUBLE
CLEANING

2

DTS

SYSTEM

WPP

PROTECT

PROTECT



**AR BLUE
CLEAN**



2X 2 POWER UNITS,
DOUBLE
CLEANING



arblueclean.it

**AR BLUE
CLEAN**



LOGISTIC DATA

Dati logistici



Index

DATI LOGISTICI
logistic data



Serie Series	Modello Model	AR code	EAN code	Dimensione scatola Box dimensions	Dimensioni esterne Outer dimensions	Q.ty Euro pallet (800x1200 mm)	Container		Camion Full Truck	Peso Weight	Pag.
				(L x W x H) mm	(L x W x H) mm		20 ft	40 ft			
1	117	13689	8016287136891	260x235x470	220x235x460	60	1038	2103	1980	6	18
1	143	13690	8016287136907	300x235x470	280x240x650	44	903	1818	1452	7	19
3	386	14831	8016287148313	440x375x620	420x340x870	15	288	580	495	12,4	20
3	396	14815	8016287148153	590x375x568	420x340x870	12	228	468	396	15,7	21
3	399	14588	8016287145886	590x375x568	400x350x855	12	288	468	396	20	22
4	491	13694	8016287136945	590x375x568	420x360x930	12	228	468	396	23	23
DSS	2.0	14986	8016287149860	360x340x815	330x307x790	12	312	624	396	13,1	27
DSS	3.0	14988	8016287149884	360x340x815	330x307x790	12	312	624	396	13,4	28
DTS	4.0	14792	8016287147927	420x395x770	449x388x895	10	210	435	330	16,7	33
DTS	5.0	14793	8016287147934	420x395x770	449x388x895	10	210	435	330	17,3	34
5	589	14989	8016287149891	420x395x770	449x388x895	10	210	435	330	27	36
5	591	14990	8016287149907	420x395x770	449x388x895	10	210	435	330	28	37
6	610	12358	8016287123587	530x280x340	350x220x240	24	264	600	792	19	66
6	613	13975	8016287139755	300x500x420	460x280x260	24	264	576	792	20,3	67
6	614	13977	8016287139779	300x500x420	460x280x260	24	264	576	792	23	67
6	615	14058	8016287140594	300x500x420	460x280x260	24	264	576	792	23	67
6K	613 K	13976	8016287139762	487x495x600	460x450x510	6	66	150	198	29,2	68
6K	614 K	13978	8016287139786	487x495x600	460x450x510	6	66	150	198	31,7	68
6K	615 K	14059	8016287140591	487x495x600	460x450x510	6	66	150	198	31,7	68
6	625	13711	8016287137119	530x280x340	390x240x230	24	264	600	792	26	70
6	630	12360	8016287123600	530x280x340	390x240x230	24	264	600	792	29	70
6	650	12455	8016287124553	530x280x340	390x240x230	24	264	600	792	29	70
6K	630 K	14633	8016287146333	487x495x600	460x450x510	6	66	150	198	35,9	71
6	670	14680	8016287146807	507x267x330	380x239x260	24	264	600	792	22	72
6	671	14697	8016287146975	507x267x330	380x239x260	24	264	600	792	25,5	72
6	672	14681	8016287146814	507x267x330	380x239x260	24	264	600	792	25,5	72
7	737	12361	8016287123617	800x400x580	390x380x900	9	99	225	297	31	74
7	747	12362	8016287123624	800x400x580	390x380x900	9	99	225	297	33	74
7	767	12364	8016287123648	800x400x580	390x380x900	9	99	225	297	39	75
7	780	22341	8016287223416	800x400x580	390x380x900	9	99	225	297	45	76
7	787	22320	8016287223201	800x400x580	390x380x900	9	99	225	297	47	76
7	797	22321	8016287223218	800x400x580	390x380x900	9	99	225	297	47	76
9	930	14261	8016287142618	705x540x720	800x480x980	6	102	204	219	50	81
9	940	14503	8016287145039	705x540x720	800x480x980	6	102	204	219	55	81



Serie Series	Modello Model	AR code	EAN code	Dimensione scatola Box dimensions	Dimensioni esterne Outer dimensions	Q.ty Euro pallet (800x1200 mm)	Container		Camion Full Truck	Peso Weight	Pag.
				(L x W x H) mm	(L x W x H) mm		20 ft	40 ft			
9	950	14262	8016287142625	705x540x720	800x480x980	6	102	204	219	52	81
9	970	14504	8016287145046	705x540x720	800x480x980	6	102	204	219	62	81
9	990	14505	8016287145053	705x540x720	800x480x980	6	102	204	219	62	81
10	1000 K	25541	8016287255417	487x495x600	460x460x810	6	66	150	198	27,8	84
10	1001 K	25542	8016287255424	487x495x600	460x460x810	6	66	150	198	28	85
10	1003 K	25543	8016287255431	487x495x600	460x460x810	6	66	150	198	42,2	86
10	1004 K	25544	8016287255448	487x495x600	460x460x810	6	66	150	198	44,2	86
10	1001	24384	8016287243841	725x490x770	670x490x900	4	60	120	132	35,9	87
10	1001 RLW	24388	8016287243889	725x490x770	670x540x900	4	60	120	132	39,2	87
10	1003	24385	8016287243858	725x490x770	670x490x900	4	60	120	132	49,7	88
10	1003 RLW	24389	8016287243896	725x490x770	670x540x900	4	60	120	132	53	88
10	1004	25302	8016287253024	725x490x770	670x490x900	4	60	120	132	51	88
10	1004 RLW	25303	8016287253031	725x490x770	670x540x900	4	60	120	132	54	88
10	1007	25150	8016287251501	725x490x770	670x490x900	4	60	120	132	64	89
10	1007 RLW	25304	8016287253048	725x490x770	670x540x900	4	60	120	132	67,7	89
10	1008	25305	8016287253055	725x490x770	670x490x900	4	60	120	132	65	89
10	1008 RLW	25306	8016287253062	725x490x770	670x540x900	4	60	120	132	69	89
10	1010	25282	8016287252829	590x800x610	580x1020x830	6	180	360	198	61	90
10	1015	25283	8016287252836	590x800x610	580x1020x830	6	180	360	198	64	90
10	1018	24491	8016287244916	590x800x610	580x1020x830	6	180	360	198	85	91
10	1018H	25272	8016287252720	590x800x610	580x1020x830	6	180	360	198	85	92
11	1120	22374	8016287223744	690x1070x620	650x1250x900	2	90	180	66	120	93
11	1125	22375	8016287223751	840x1440x1100	820x1400x900	1	20	40	33	260	94
11	1130	22376	8016287223768	840x1440x1100	820x1400x900	1	20	40	33	290	95
12	1230	22377	8016287223775	535x880x680	400x650x330	6	72	144	198	72	96
12	1240	22378	8016287223782	535x880x680	400x650x330	6	72	144	198	75	96
12	1250 S	26360	8016287263603	672x450x424	353x577x350	8	215	450	264	40,2	97
12	1255 S	26332	8016287263320	672x450x424	353x577x350	8	215	450	264	42,7	97
12	1260 S	26361	8016287263610	791x463x470	365x743x402	8	165	350	264	55,3	98
12	1270 S	26362	8016287263627	791x463x470	365x743x402	8	165	350	264	56,3	98
12	1280 S	26291	8016287262910	791x463x470	421x743x386	8	165	350	264	61,3	99
12	1290 S	26267	8016287262675	791x463x470	421x743x386	8	165	350	264	61,8	99
14	1415	26213	8016287262132	520x440x520	460x460x480	8	176	384	264	17,4	104
14	1425	26215	8016287262156	510x590x565	650x505x890	6	168	352	198	25,9	105



Index

DATI LOGISTICI
logistic data



Serie Series	Modello Model	AR code	EAN code	Dimensione scatola Box dimensions	Dimensioni esterne Outer dimensions	Q.ty Euro pallet (800x1200 mm)	Container		Camion Full Truck	Peso Weight	Pag.
				(L x W x H) mm	(L x W x H) mm		20 ft	40 ft			
14	1435	26406	8016287264068	520x690x565	771x458x926	6	140	292	198	31,8	106
14	1440	26216	8016287262163	520x690x565	771x458x926	6	140	292	198	31,4	107
14	1445	26407	8016287264075	520x690x565	771x458x926	6	140	296	198	31,7	108
14	1450	26217	8016287262170	520x690x565	771x458x926	6	140	296	198	34,7	109
14	1460	26218	8016287262187	830x595x690	900x530x900	6	75	162	198	53,5	110
14	1475	26325	8016287263252	830x595x640	900x530x900	6	75	162	198	58,4	110
14	1480	26219	8016287262194	830x595x690	900x530x900	6	75	162	198	58,6	110
14	1490	26408	8016287264082	830x595x690	900x530x900	6	75	162	198	64	111
14	1492	27348	8016287273480	830*595*690	900*530*900	6	75	162	198	64	111
25	2590	24424	8016287244244	510x770x700	500x730x920	6	99	207	198	46	134
35	3590	24425	8016287244251	510x770x700	500x730x920	6	99	207	198	52	134
45	4590	24426	8016287244268	510x770x700	500x730x920	6	99	207	198	52,8	134
56	5640	25670	8016287256704	790x560x545	540x800x750	4	60	120	132	85	136
56	5670	25671	8016287256711	790x560x545	540x800x750	4	60	120	132	86	136
58	5850	25672	8016287256728	790x560x545	540x800x750	4	60	120	132	89	137
58	5870	25673	8016287256735	790x560x545	540x800x750	4	60	120	132	90	137
66	6640	25275	8016287252751	1000x580x840	1000x570x820	2	22	50	66	82	138
66	6670	25288	8016287252881	1000x580x840	1000x570x820	2	22	50	66	85	138
69	6950	24103	8016287241038	1060x740x960	980x590x920	2	22	50	66	94	139
69	6970	25276	8016287252768	1060x740x960	980x590x920	2	22	50	66	98	139
78	7850	25277	8016287252775	1060x740x960	980x590x920	2	22	50	66	94	140
78	7870	25278	8016287252782	1060x740x960	980x590x920	2	22	50	66	98	140
88	8840	25913	8016287259132	1120x730x1060	1100x700x1040	1	11	25	33	135	141
88	8860	25914	8016287259149	1120x730x1060	1100x700x1040	1	11	25	33	135	141
88	8880	22915	8016287229159	1120x730x1060	1100x700x1040	1	11	25	33	135	141
13	1310	24894	8016287248945	1150x720x750	1100x650x700	4	44	88	132	105	142
13	1320	25273	8016287252737	1150x720x750	1100x650x700	4	44	88	132	110	142
13	1325	25274	8016287252744	1150x720x750	1100x650x700	4	44	88	132	110	142
13	1380	23658	8016287236584	1200x750x1000	1180x730x960	2	22	44	66	150	143
31	3170	51922	8016287519229	380x355x405	346x339x385	30	552	1140	990	6,4	156
32	3270	51923	8016287519236	380x355x533	346x339x509	24	412	856	792	7,0	157
33	3370	51924	8016287519243	410x410x485	415x415x473	24	339	688	792	8,1	158
36	3670	51927	8016287519274	410x410x605	415x415x554	18	260	524	594	8,4	159
37	3770	51928	8016287519281	495x460x570	465x444x560	6	220	460	198	11,7	160



Serie Series	Modello Model	AR code	EAN code	Dimensione scatola Box dimensions	Dimensioni esterne Outer dimensions	Q.ty Euro pallet (800x1200 mm)	Container		Camion Full Truck	Peso Weight	Pag.
				(L x W x H) mm	(L x W x H) mm		20 ft	40 ft			
37	3780	51929	8016287519298	625x575x645	538x683x852	6	108	228	198	16,8	161
ASH	E12B	52004	8016287520041	260x260x340	255x255x335	56	1150	2410	1848	4,3	163
	E15	51993	8016287519939	315x315x325	310x300x305	36	882	1862	1188	4,2	164
	MID20	51583	8016287515832	320x320x400	320x320x390	36	728	1496	1188	3,8	165
	TOP20	51582	8016287515825	320x320x400	320x320x390	36	728	1496	1188	3,8	166
	M20	52013	8016287520133	410x410x485	415x415x473	24	339	688	795	8,9	167
39	3930	51930	8016287519304	690x390x690	360x385x685	18	198	450	594	8,6	174
39	3950	51931	8016287519311	510x630x980	530x565x970	8	88	200	264	26	175
39	3970	51932	8016287519328	510x630x980	530x565x970	8	88	200	264	27,5	176
41	4100	51180	8016287511803	415x415x580	400x400x900	18	280	560	594	11	178
42	4200	51181	8016287511810	415x415x580	400x400x800	15	168	336	495	13,7	179
42	4200 P	51061	8016287510615	415x415x580	415x415x875	15	168	336	495	12,6	180
43	4300 P	51062	8016287510622	590x615x1060	600x600x1100	4	54	120	133	22	181
44	4400 P	51064	8016287510646	590x615x1060	600x600x1100	4	54	120	133	27	181
43	4300 E	51063	8016287510639	415x415x800	400x400x800	15	168	336	495	21	182
43	4300	50182	8016287501828	590x615x1060	600x600x1100	4	54	120	133	24	185
44	4400	50183	8016287501835	590x615x1060	600x600x1100	4	54	120	133	29	186
47	4700 S	51065	8016287510653	415x415x800	600x600x1100	15	168	336	495	14	187
48	4800	51203	8016287512039	410x410x810	600x600x1100	15	175	362	495	13,9	188
42	4200 L	51289	8016287512893	415x415x820	400x400x800	15	168	336	495	14	189
43	4300 L	51205	8016287512053	590x615x1060	620x620x1000	4	54	120	133	27,5	190
49	4900	51067	8016287510677	500x600x1060	590x550x1040	4	84	176	133	29,8	191
ARGP	600P	51986	8016287519861	370x225x260	340x210x210	*	1100	2260	*	7,4	210
ARGP	800X	51988	8016287519885	370x225x260	340x210x210	*	1030	2115	*	7,8	211
ARGP	1100X	51990	8016287519908	410x250x280	380x220x225	*	1030	2115	*	10,4	212
ARGP	600PB	51987	8016287519878	485x300x550	440x270x510	*	350	730	*	11,8	216
ARGP	800XB	51989	8016287519892	485x300x550	440x270x510	*	350	730	*	12,2	217
ARGP	1100XB	51991	8016287519915	520x300x560	500x270x530	*	335	690	*	15,4	219
ARUP	250PC	51982	8016287519823	460x340x350 [◇]	165x158x305	*	1864	3436	*	18,3	222
ARUP	750XC	51984	8016287519847	460x380x360 [◇]	150x150x312	*	1864	3436	*	23,1	223
ARUP	750PT	51983	8016287519830	460x340x380 [◇]	167x160x357	*	1672	3432	*	23,9	224
ARUP	1100XD	51985	8016287519854	460x380x400 [◇]	187x167x382	*	1588	3264	*	29,5	227

* Dati disponibili su richiesta / Data available on request ◇ 4 pezzi / 4 pcs



Idropultrici
High Pressure Washers



Applicazioni Applications	cancellate fencing	panchine benches	giardino garden	biciclette bicycles	moto motorcycle	auto cars	camper recreational vehicles RVs, campers	barche boats	pavimenti flooring, paving stones	scale stairs	piscine pools	utensili tools	casa house	muri walls	tetti roofs	edilizia construction	agricoltura zootecnica agriculture zootechny	artigianato crafts	car wash	automotive	
Tecniche Technical	pressione massima max pressure	portata massima max flow rate	potenza assorbita absorbed power	peso netto net weight	motore universale universal engine	motore induzione induction engine	motore benzina gasoline engine	pompa a piattello wobble plate pump	pompa a bielle rod-crank pump	testa in ottone brass head	testa in alluminio aluminum head	testa nichelata nichel plated head	temperatura massima max temperature	resistenza all'acqua water resistance	TSS [®] Total Stop SYSTEM	TST [®] Total Stop SYSTEM TIMED	DTS [®] DUALTECH SYSTEM	DSS [®] DUAL SPEED SYSTEM	acqua fredda cold water	acqua calda hot water	regolabile adjustable
Funzioni Functions	+50% WPP washing performance power prestazioni lavaggio	+70% FASTER risparmio tempo time savings	Up to 5mt altezza raggiungibile reachable height																		

Aspiratori
Vacuums



Applicazioni Applications	liquidi fluids	grandi volumi big volumes	interni houses	cantine cellars	soffitte lofts	autorimesse garages	balconi balcony	cucce dog house, kennels	piccoli cantieri little work sites	veicoli cars	poltrone divani armchairs couches	spazi ristretti limited spaces	stufe heaters	camini fireplaces	griglie grills	edilizia construction	agricoltura zootecnica agriculture zootechny	artigianato crafts	car wash	automotive
Tecniche Technical	potenza assorbita absorbed power	peso netto net weight	n° motori engines n°	stadi motore engine stages	depressione vacuum pressure	aria aspirata air flow rate	rumorosità loudness	capacità fusto capacity	diametro accessori accessory diameter	working time tempo di utilizzo	recharging time tempo di ricarica									
Funzioni Functions	aspirazione liquidi liquid suction	aspirazione polveri dust suction	funzione soffiante blow function	aspirazione cenere ash suction	presa elettro-utensile power tool socket suction															

Pompe
Water Pumps



Applicazioni Applications	irrigazione manuale manual irrigation	irrigazione automatica automatic irrigation	acque per i servizi water supply	allagamenti domestici house flooded	pozzetti wells	piscine swimming pools	cantieri construction site	stagni/laghetti ponds	allagamenti floodings											
Tecniche Technical	pressione massima max pressure	portata massima max flow	dimensioni di montaggio fitting dimensions	ON/OFF automatico automatic ON/OFF	sistema di scarico drain system	facile riempimento easy fill	impugnatura ergonomica handle	montaggio da tavolo table mounting	serbatoio tank	ON/OFF automatico automatic ON/OFF	acqua residua residual water	dimensione massima particolato max grain size	altezza variabile variable height	corpo in acciaio inossidabile stainless steel body	testata pompa in acciaio inossidabile stainless steel pump head	portata massima max flow rate	potenza assorbita absorbed power	peso netto net weight	temperatura massima max temperature	resistenza all'acqua water resistance
Funzioni Functions	adatto ad acque pulite suitable for clean water	adatto ad acque sporche suitable for dirty water																		

Performance

Generiche Generic

Logistiche Logistics



OLIGHTPRO

HEAVYPRO



plug&play
plug&play



novità
new



trade selection



euro pallet
euro pallet



full track
full truck



20" container



40" container



dimensioni
dimension
dimension
packaging
machine



dimensioni
dimension
dimension
macchina
machine



peso lordo
gross
weight



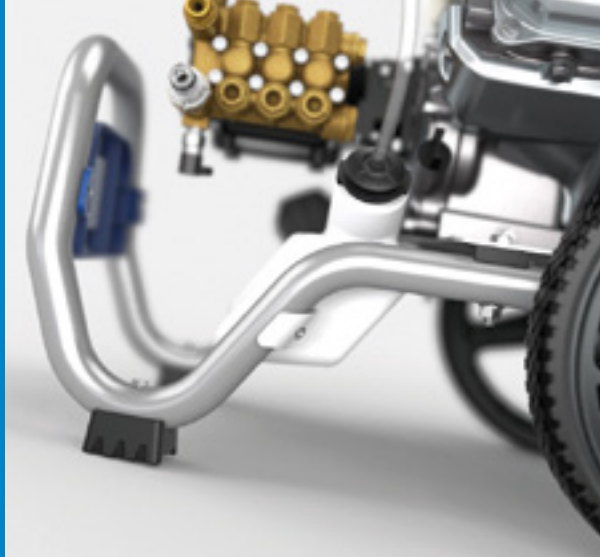
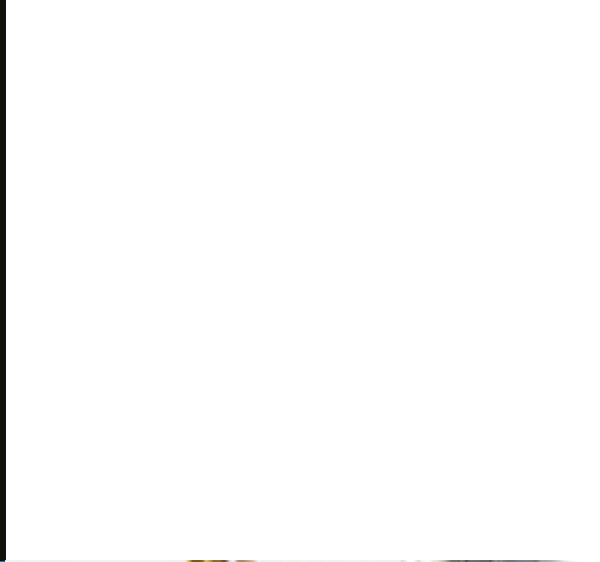

CATALOGO CLEANING DIVISION CATALOGUE

aprire qui per
legenda icone
For icons list
open here

Annovi Reverberi spa

Cleaning Division
Via Aldo Moro 40
41030 Bompporto, Mo (Italy)
Tel +39 059 8199 011
Fax +39 059 8199 000
info@arblueclean.it
www.arblueclean.it

Agriculture & Industry Division
Via Martin L. King 3
41122 Modena (Italy)
Tel +39 059 414 411
Fax +39 059 253 505
infoar@annovireverberi.it
www.annovireverberi.it

AR North America Inc.

140 - 81st Avenue Northeast
Fridley, MN USA 55432
Ph. +1 763 398 2008
Fax +1 763 398 2009
info@arnorthamerica.com
www.arnorthamerica.com

AR China Distribution Co., Ltd

2nd Floor, Building 1, No. 651 Jiangting Rd.
Jinhui Town, Fengxian District, Shanghai
201404 China
Ph. +86 21 54846800
Fax +86 21 54846800 ext 815
info@ar-china.cn
www.ar-china.cn

© 2020 Annovi Reverberi